



HP ProBook 450 G0 Notebook PC
HP ProBook 455 G1 Notebook PC

Maintenance and Service Guide

© Copyright 2013 Hewlett-Packard
Development Company, L.P.

Bluetooth is a trademark owned by its proprietor and used by Hewlett-Packard Company under license. Intel and Core are trademarks or registered trademarks of Intel Corporation in the United States and other countries. Microsoft, Windows, and Windows Vista are either trademarks or registered trademarks of Microsoft Corporation in the United States and/or other countries. SD Logo is a trademark of its proprietor.

The information contained herein is subject to change without notice. The only warranties for HP products and services are set forth in the express warranty statements accompanying such products and services. Nothing herein should be construed as constituting an additional warranty. HP shall not be liable for technical or editorial errors or omissions contained herein.

First Edition: May 2013

Document Part Number: 720794-001

Product notice

This guide describes features that are common to most models. Some features may not be available on your computer.

Important Notice about Customer Self-Repair Parts

 **CAUTION:** Your computer includes Customer Self-Repair parts and parts that should only be accessed by an authorized service provider. See Chapter 5, "Removal and replacement procedures for Customer Self-Repair parts," for details. Accessing parts described in Chapter 6, "Removal and replacement procedures for Authorized Service Provider only parts," can damage the computer or void your warranty.

Safety warning notice

 **WARNING!** To reduce the possibility of heat-related injuries or of overheating the computer, do not place the computer directly on your lap or obstruct the computer air vents. Use the computer only on a hard, flat surface. Do not allow another hard surface, such as an adjoining optional printer, or a soft surface, such as pillows or rugs or clothing, to block airflow. Also, do not allow the AC adapter to contact the skin or a soft surface, such as pillows or rugs or clothing, during operation. The computer and the AC adapter comply with the user-accessible surface temperature limits defined by the International Standard for Safety of Information Technology Equipment (IEC 60950).

Table of contents

1 Product description	1
2 External component identification	7
Display	7
Top	8
TouchPad	8
Lights	9
Buttons and fingerprint reader (select models only)	10
Keys	12
Front	13
Left	14
Right	15
Service tag and PCID label	16
Service tag	16
PCID label	17
3 Illustrated parts catalog	18
Computer major components	18
Display components	22
Plastics Kit	23
Cable Kit	24
Mass storage devices	25
Miscellaneous parts	26
Sequential part number listing	27
4 Removal and replacement procedures preliminary requirements	32
Tools required	32
Service considerations	32
Plastic parts	32
Cables and connectors	33
Drive handling	33
Grounding guidelines	34
Electrostatic discharge damage	34
Packaging and transporting guidelines	35
Workstation guidelines	35
Equipment guidelines	36

5 Removal and replacement procedures for Customer Self-Repair parts	37
Component replacement procedures	37
Battery	38
Service door	39
Using the optional security screw	40
Hard drive	40
Optical drive	43
Memory modules	45
WLAN/Bluetooth combo card	47
WWAN module	49
Keyboard	51
6 Removal and replacement procedures for Authorized Service Provider parts	53
Component replacement procedures	53
RTC battery – models without WWAN	54
Top cover	55
Speaker assembly	60
Fingerprint reader assembly	62
Power button board	63
Function board	65
Card reader board	66
USB/audio board	68
System board	69
Optical drive extension board	72
Power cable	72
Battery cable	74
RTC battery – WWAN models	75
Fan/heat sink assembly	77
Processor	80
Display assembly	82
7 Computer Setup (BIOS), MultiBoot, and System Diagnostics in Windows 8	89
Using Computer Setup	89
Starting Computer Setup	89
Navigating and selecting in Computer Setup	89
Restoring factory settings in Computer Setup	90
Updating the BIOS	90
Determining the BIOS version	90
Downloading a BIOS update	91
Using MultiBoot	92

About the boot device order	92
Choosing Multi Boot preferences	92
Setting a new boot order in Computer Setup	92
Dynamically choosing a boot device using the f9 prompt	93
Setting a MultiBoot Express prompt	93
Entering MultiBoot Express preferences	93
Using System Diagnostics	94
8 Setup Utility (BIOS) and System Diagnostics in Windows 7	95
Using Setup Utility	95
Starting Setup Utility	95
Changing the language of Setup Utility	95
Navigating and selecting in Setup Utility	96
Displaying system information	96
Restoring factory settings in Setup Utility	97
Exiting Setup Utility	97
Updating the BIOS	97
Determining the BIOS version	98
Downloading a BIOS update	98
Using System Diagnostics	99
9 Computer Setup (BIOS) and Advanced System Diagnostics in SUSE Linux	100
Starting Computer Setup	100
Using Computer Setup	100
Navigating and selecting in Computer Setup	100
Restoring factory settings in Computer Setup	101
Updating the BIOS	101
Determining the BIOS version	101
Downloading a BIOS update	102
Using Advanced System Diagnostics	102
10 Backup and recovery in Windows 8	104
Backing up your information	104
Performing a system recovery	105
Using the Windows recovery tools	105
Using f11 recovery tools	105
Using Windows 8 operating system media (purchased separately)	106
Using Windows Refresh for quick and easy recovery	107
Remove everything and reinstall Windows	107
Using HP Software Setup	108

11 Backup and recovery in Windows 7	109
Creating recovery media with HP Recovery Disc Creator	109
Creating recovery media	110
Backing up your information	110
Performing a system recovery	111
Using the Windows recovery tools	111
Using f11 recovery tools	112
Using a Windows 7 operating system DVD (purchased separately)	112
12 Backup and Recovery in SUSE Linux	114
Backing up your information	114
Performing a system recovery	114
13 Specifications	116
Computer specifications	116
39.6-cm (15.6-in), HD+ display specifications	117
Hard drive specifications	118
DVD±RW SuperMulti DL Drive specifications	119
Blu-ray ROM DVD±RW SuperMulti DL Drive	120
DVD-ROM drive	120
Specification information in Device Manager	121
14 Statement of Volatility	122
Non-volatile memory usage	124
Questions and answers	126
15 Power cord set requirements	127
Requirements for all countries and regions	127
Requirements for specific countries and regions	127
16 Recycling	129
Battery	129
Display	129
Index	135

1 Product description

Category	Description	HP 450 UMA	HP 450 discrete	HP 455 UMA	HP 455 discrete
Product Name	HP ProBook 450 G0 Notebook PC	✓	✓		
	HP ProBook 455 G1 Notebook PC			✓	✓
Processors	Intel® Core™ i7 processor, Quad Core, 3rd generation (6-MB L3 cache, 35W)				
	3632QM, 2.20-GHz processor	✓	✓		
	Intel® Core i5 processors, Dual Core, 3rd generation (3-MB L3 cache, 35W)				
	3380M, 2.90-GHz processor	✓	✓		
	3340M, 2.70-GHz processor	✓	✓		
	3230M, 2.60-GHz processor	✓	✓		
	Intel Core i3 processors, Dual Core, 3rd generation (3-MB L3 cache, 35W)				
	3130M, 2.60-GHz processor	✓	✓		
	3120M, 2.50-GHz processor				
	Intel Pentium processor, Dual Core (2-MB L3 cache, 35W)				
	2020M, 2.40-GHz processor	✓	✓		
	Intel Celeron processor (2-MB L3 cache, 35W)				
	1000M, 1.80-GHz processor	✓	✓		
	AMD processors				
	AMD A8-5550M, 35W, Quad Cores, 3.1 GHz/2.1 GHz 4 MB L2 cache/HD 8550G graphics			✓	✓
	AMD A8-4500M, 35W, Quad Cores, 2.8 GHz/1.9 GHz 4 MB L2 cache/HD 7640G graphics			✓	✓
AMD A6-5350M, 35W, Dual Cores, 3.5 GHz/2.9 GHz 1 MB L2 cache/HD 8450G graphics			✓	✓	
AMD A6-4400M, 35W, Dual Cores, 3.2 GHz/2.7 GHz 1 MB L2 cache/HD 7520G graphics			✓	✓	
AMD A4-5150M, 35W, Dual Cores, 3.3 GHz/2.7 GHz, 1 MB L2 cache/HD 8350G graphics			✓	✓	
AMD A4-4300M, 35W, Dual Cores, 3.0 GHz/2.5 GHz, 1 MB L2 cache/HD 7420G graphics			✓	✓	
Chipset	Mobile Intel HM76 chipset	✓	✓		
	AMD A76M FCH			✓	✓

Category	Description	HP 450 UMA	HP 450 discrete	HP 455 UMA	HP 455 discrete
Graphics	AMD Radeon™ HD 8750M (switchable discrete)		✓		✓
	Intel HD Graphics 4000 (Intel i3/i5/i7 processors)	✓			
	Intel HD Graphics (Intel Pentium/Celeron processors)	✓			
	Supports HD decode, DX11, HDMI	✓	✓	✓	✓
	Supports PX5.5		✓		
	Supports PX5			✓	✓
Panel	39.6-cm (15.6-inch) HD, 1366x768, 200 nits, 3.6 mm	✓	✓		
	39.6-cm (15.6-inch) HD, 1366x768, 200 nits, 3.6 mm, includes WWAN	✓			
	39.6-cm (15.6-inch) HD, 1366x768, 200 nits, touchpanel, includes WWAN and webcam	✓	✓		
	39.6-cm (15.6-inch) HD, 1366x768, 200 nits, 3.8 mm			✓	✓
	All display assemblies include 2 wireless local area network (WLAN) antennas	✓	✓	✓	✓
	Display assemblies include 2 worldwide 5-band (WWAN) antennas	✓			
Memory	Two customer-accessible memory module slots supporting up to 16 GB of RAM	✓	✓	✓	✓
	Supports dual-channel memory	✓	✓	✓	✓
	PC3L-12800, 1600-MHz, DDR3L SODIMMs	✓	✓	✓	✓
	Supports the following configurations:	✓	✓	✓	✓
	<ul style="list-style-type: none"> • 16384 MB (8192 × 2; dual channel) • 12288 MB (8192 + 4096; dual channel) • 8192 MB (8192 × 1) • 8192 MB (4096 × 2; dual channel) • 6144 MB (4096 + 2048; dual channel) • 4096 MB (2048 × 2; dual channel) • 4096 MB (4096 × 1) • 2048 MB (2048 × 1) 				
Primary storage	Supports 7-mm/9.5-mm, 2.5-in SATA hard drives with HP 3D DriveGuard	✓	✓	✓	✓
	Customer-accessible	✓	✓	✓	✓
	Supports the following drives:	✓	✓		
	<ul style="list-style-type: none"> • 1-TB, 5400-rpm • 750-GB, 5400-rpm • 500-GB, 7200-rpm • 500-GB, 5400-rpm, hybrid (8-GB SSD) MLC 				

Category	Description	HP 450 UMA	HP 450 discrete	HP 455 UMA	HP 455 discrete
	<ul style="list-style-type: none"> 320-GB, 5400-rpm 128-GB Solid-state drive (SSD) 				
	Supports the following drives:			√	√
	<ul style="list-style-type: none"> 750-GB, 5400-rpm 500-GB, 7200-rpm, 5400-rpm 320-GB, 5400-rpm 				
Fixed optical drives	Supports the following 12.7-mm SATA optical drives:	√	√	√	√
	<ul style="list-style-type: none"> DVD-ROM DVD+/-RW SuperMulti DL 				
	Blu-ray ROM DVD+/-RW SuperMulti DL	√	√		
	Supports no optical drive option	√	√	√	√
Audio/Visual	Integrated webcam (720p HD)	√	√	√	√
	Stereo speakers (2)	√	√	√	√
	Integrated dual-array microphone (webcam models only)	√	√	√	√
	Integrated mono microphone (non-webcam models only)	√		√	√
	Headphone and microphone jacks	√	√	√	√
	IDT 92HD91	√	√	√	√
	Skype-ready	√	√	√	√
	HD audio with DTS Sound+	√	√	√	√
	Supports “no camera” option	√		√	
Ethernet	Realtek RTL8151GH-CG 10/100/1000	√	√	√	√
	S3/S4/S5 wake on LAN (AC mode and battery mode)	√	√	√	√
	NIC power down technology	√	√	√	√
	Ethernet cable not included	√	√	√	√
Wireless	Integrated WLAN options by way of wireless module:	√	√	√	√
	Two WLAN antennas built into display assembly	√	√	√	√
	Supports “no WLAN/Bluetooth” option	√	√	√	√
	Supports the following WLAN formats:	√	√	√	√
	<ul style="list-style-type: none"> Atheros AR9485 802.11b/g/n 1x1 WiFi Adapter Atheros AR9565 802.11bgn 1x1 WiFi + BT4.0 combo Adapter Ralink RT3290LE 802.11bgn 1x1 Wi-Fi and Bluetooth® 4.0 Combo Adapter Realtek RTL8188EE 802.11bgn Wi-Fi Adapter 				
	Supports the following WLAN formats:	√	√		

Category	Description	HP 450 UMA	HP 450 discrete	HP 455 UMA	HP 455 discrete
	<ul style="list-style-type: none"> Intel Centrino Advanced-N 6235 BCM943228HM4L 802.11abgn 2x2 Wi-Fi Adapter and Broadcom Bluetooth 4.0 Adapter 				
	Wireless Personal Area Network (PAN) only supported by Bluetooth 4.0 combo card	√	√	√	√
	Integrated WWAN options by way of wireless module:				
	Two WWAN antennas built into display assembly (world-wide 5 band, configured with panels)	√			
	Subscriber identity module (SIM) security (customer-accessible)	√			
	Supports “no WWAN” option	√			
	Supports the following WWAN modules:	√			
	<ul style="list-style-type: none"> HP hs3110 HSPA+ Mobile Broadband Module HP lt4112 LTE/HSPA+ Gobi 4G Module 				
External media card	Digital Media Reader Slot	√	√	√	√
	Supports SD, SDHC, SDXC, Memory Stick, MSXC				
Ports	Audio-in (stereo microphone)	√	√	√	√
	Audio-out (stereo headphone)	√	√	√	√
	RJ-45 (Ethernet, includes link and activity lights)	√	√	√	√
	USB 3.0 (2)	√	√	√	√
	USB 2.0 (2)	√	√	√	√
	VGA (Dsub 15-pin) supporting 2048 × 1536 external resolution at 75-GHz (hot plug/unplug with auto-detect)	√	√		
	VGA (Dsub 15-pin) supporting 1920 × 1200 external resolution at 75-GHz (hot plug/unplug with auto-detect)			√	√
	HDMI 1.4	√	√	√	√
	Multi-pin AC port	√	√	√	√
Keyboard/pointing devices	Full-sized, spill-resistant keyboard	√	√	√	√
	Touchpad includes: on/off button on board; 2-way scroll with legend, taps enabled by default, 2-finger scrolling and zoom enabled by default	√	√	√	√
Power requirements	90-W Smart AC adapter with localized cable plug support (3-wire plug with ground pin)		√		√
	65-W Smart AC adapter with localized cable plug support (3-wire plug with ground pin)	√		√	
	6-cell, 47-Wh, 2.2Ah, Li-ion battery (HP Fast Charge technology)	√	√	√	√
	9-cell, 93-Wh, 2.8 Ah, Li-ion battery				

Category	Description	HP 450 UMA	HP 450 discrete	HP 455 UMA	HP 455 discrete
Security	Integrated fingerprint reader (optional)	√	√	√	√
	Intel AT support	√	√		
	Security lock	√	√	√	√
	No fingerprint reader option	√	√	√	√
Operating system	Preinstalled:				
	Windows 7 Professional 64	√	√	√	√
	Windows 7 Professional 64 – MSNA (France and Russia only)	√	√	√	√
	Windows 7 Home Premium 64	√	√	√	√
	Windows 7 Home Basic 64	√	√	√	√
	Windows 8 Professional 64-bit Digital Product Key (DPK) with Windows 7 Professional 64	√	√	√	√
	Windows 8 China (CH) 64-bit	√	√	√	√
	Windows 8 Emerging Markets (EM) 64-bit	√	√	√	√
	Windows 8 Multi-language (ML) 64-bit	√	√	√	√
	Windows 8 Professional 64-bit	√	√	√	√
	Novell™: SuSE Linux™ – SLED 11, 64-bit, SP2	√	√	√	√
	FreeDOS 2.0	√	√	√	√
	Restore Media (DRDVD/SRDVD):				
	DRDVD Windows 8	√	√	√	√
	DRDVD Windows 7	√	√	√	√
	SRDVD SuSE Linux Enterprise (SLED) SP2 64-bit	√	√	√	√
	Restore Media (OSDVD):				
	Windows 7 Home Basic 64	√	√	√	√
	Windows 7 Home Premium 64	√	√	√	√
	Windows 7 Professional 32	√	√	√	√
	Windows 7 Professional 64	√	√	√	√
	Windows 8 Professional 64	√	√	√	√
	Web-only support:				
	Windows 7 Home Basic 32	√	√	√	√
	Windows 7 Home Premium 32	√	√	√	√
	Windows 7 Professional 32	√	√	√	√
	Windows 8 Professional 32	√	√	√	√
	Windows 8 ML 32	√	√	√	√

Category	Description	HP 450 UMA	HP 450 discrete	HP 455 UMA	HP 455 discrete
	Windows 8 EM 32	√	√	√	√
	Windows 8 CH 32	√	√	√	√
	Certified:				
	Microsoft WHQL	√	√	√	√
	SuSE Linux – SLED 11, 64-bit, SP2	√	√	√	√
Serviceability	End-user replaceable parts:				
	AC adapter	√	√	√	√
	Battery (system)	√	√	√	√
	Hard drive	√	√	√	√
	Memory module	√	√	√	√
	Optical drive	√	√	√	√
	WLAN module	√	√	√	√
	WWAN module	√			
	Keyboard	√	√	√	√

2 External component identification

Display

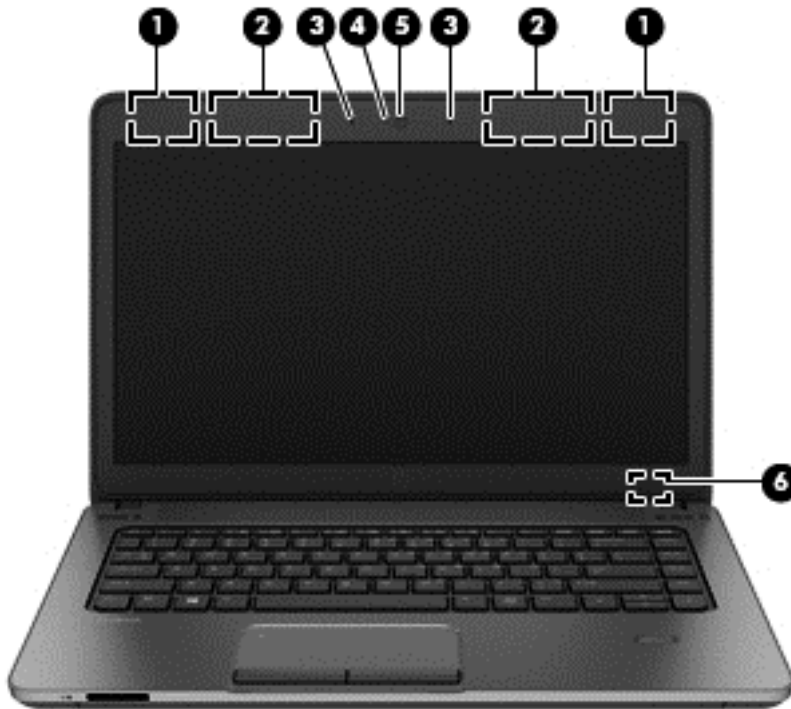

Component	Description
(1) WLAN antennas (2)* (select models only)	Send and receive wireless signals to communicate with wireless local area networks (WLAN).
(2) WWAN antennas (2)* (select models only)	Send and receive wireless signals to communicate with wireless wide area networks (WWAN).
(3) Internal microphones (2) (select models only; SLED models do not support WWAN)	Record sound.
(4) Webcam light (select models only)	On: The webcam is in use.
(5) Webcam (select models only)	Records video and captures still photographs. To use the webcam: Windows 8: From the Start screen, type o , and then select CyberLink YouCam from the list of applications. Windows 7: Select Start > All Programs > Communication and Chat > Cyberlink YouCam .
(6) Internal display switch	Turns off the display or initiates Sleep if the display is closed while the power is on.

Component	Description
	NOTE: The display switch is not visible on the outside of the computer.

*The antennas are not visible on the outside of the computer. For optimal transmission, keep the areas immediately around the antennas free from obstructions. To see wireless regulatory notices, see the section of the *Regulatory, Safety, and Environmental Notices* that applies to your country or region. To access the user guides in Windows 8, select the **HP Support Assistant** app on the Start screen, select **My computer**, and then select **User guides**. In Windows 7, these notices are located in Help and Support.

Top

TouchPad

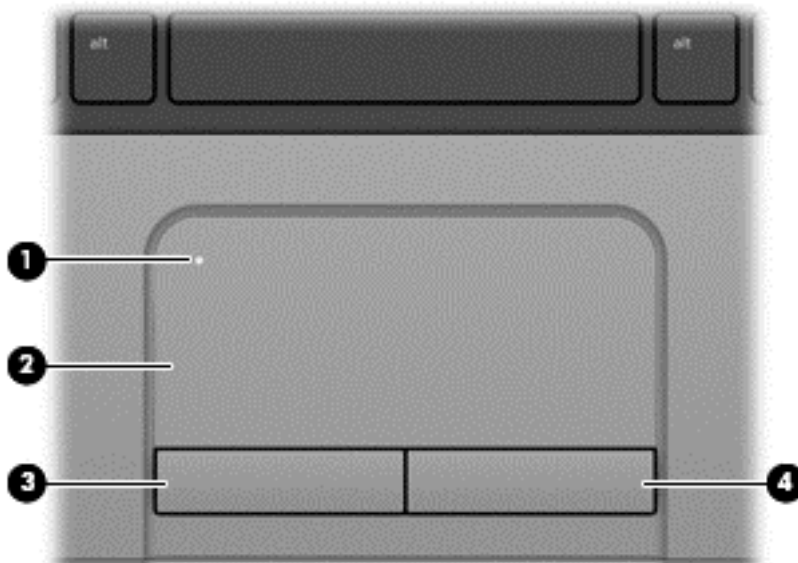





Component	Description	
(1)	TouchPad on/off button	Turns the TouchPad on and off.
(2)	TouchPad zone	Moves the pointer and selects or activates items on the screen.
(3)	Left TouchPad button	Functions like the left button on an external mouse.
(4)	Right TouchPad button	Functions like the right button on an external mouse.

Lights

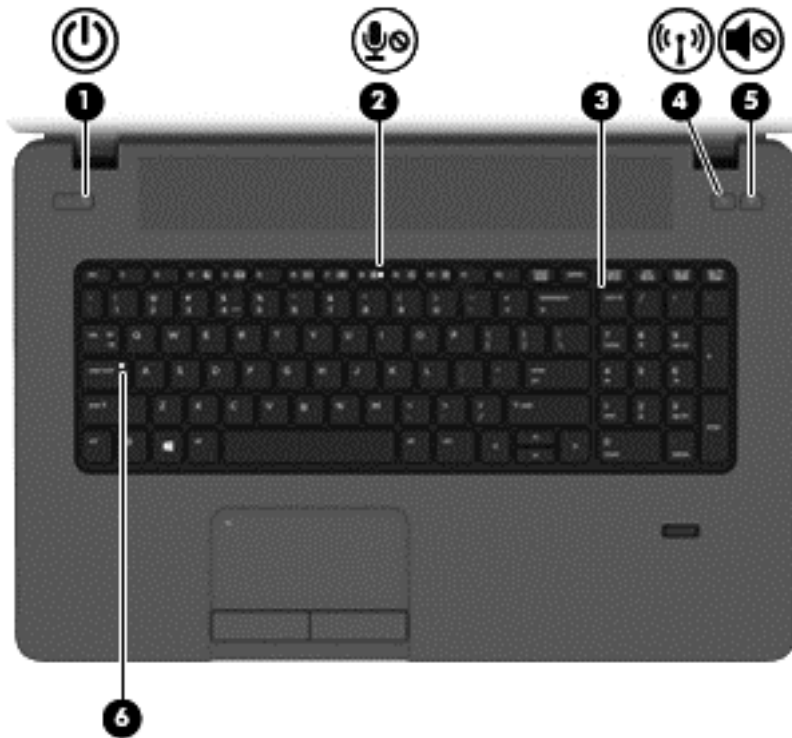

NOTE: Your computer may look slightly different from the illustration in this section.





Component	Description
(1)  Power light	<ul style="list-style-type: none">On: The computer is on.Blinking: The computer is in the Sleep state. <p>NOTE: The elapsed time between blinks is longer than on previous models.</p> <ul style="list-style-type: none">Off: The computer is off.
(2)  Microphone mute light	Amber: Microphone is off.
(3) Num lock light	On: Num lock is on.
(4)  Wireless light	<ul style="list-style-type: none">White: An integrated wireless device, such as a wireless local area network (WLAN) device and/or a Bluetooth® device, is on.Amber: All wireless devices are off.
(5)  Speaker mute	<ul style="list-style-type: none">Amber: Computer sound is off.Off: Computer sound is on.
(6) Caps lock light	On: Caps lock is on.

Buttons and fingerprint reader (select models only)

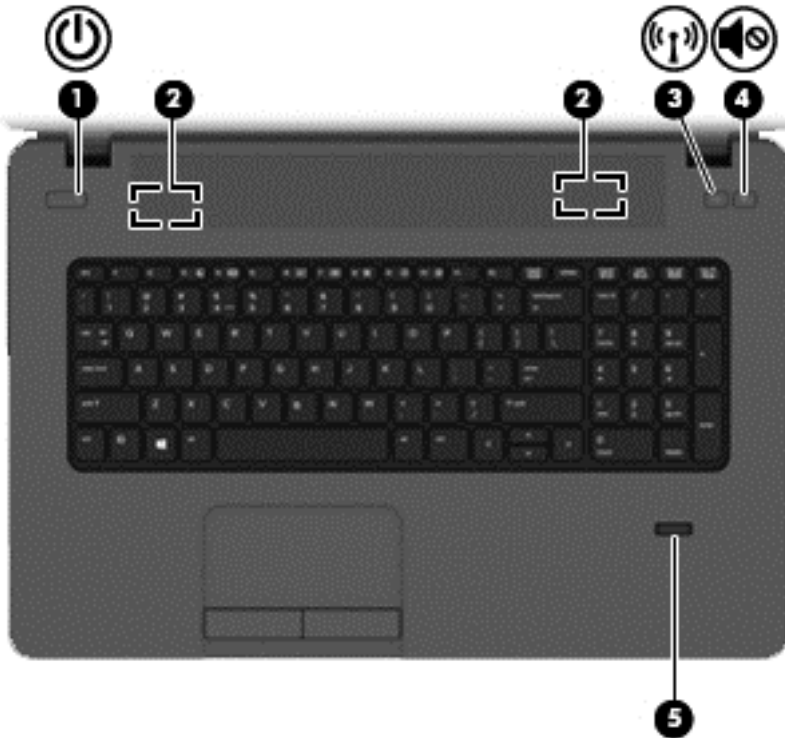
 **NOTE:** Your computer may look slightly different from the illustration in this section.



Component	Description
(1)  Power button	<ul style="list-style-type: none">• When the computer is off, press the button to turn on the computer.• When the computer is on, press the button briefly to initiate Sleep.• When the computer is in the Sleep state, press the button briefly to exit Sleep.• When the computer is in Hibernation, press the button briefly to exit Hibernation. <p>CAUTION: Pressing and holding down the power button will result in the loss of unsaved information.</p> <p>If the computer has stopped responding and Windows® shutdown procedures are ineffective, press and hold the power button for at least 5 seconds to turn off the computer.</p> <p>To learn more about your power settings, see your power options:</p> <ul style="list-style-type: none">• Windows 8: From the Start screen, type <code>power</code>, select Settings, and then select Power Options.• Windows 7: Select Start > Control Panel > System and Security > Power Options.• SLED: Select Computer > Control Center. In the left pane, click System, and then click Power Management in the right pane.

Component	Description
(2) Speakers (2)	Produce DTS Sound+. To use the DTS Sound+software: Windows 8: From the Start screen, type DTS , and then select DTS Sound+ . Windows 7: Select Start > All Programs > DTS Sound+ .
(3)  Wireless button	Turns the wireless feature on or off but does not establish a wireless connection.
(4)  Speaker mute button	Mutes and restores speaker sound.
(5) Fingerprint reader (select models only)	Allows a fingerprint logon instead of a password logon.

Keys

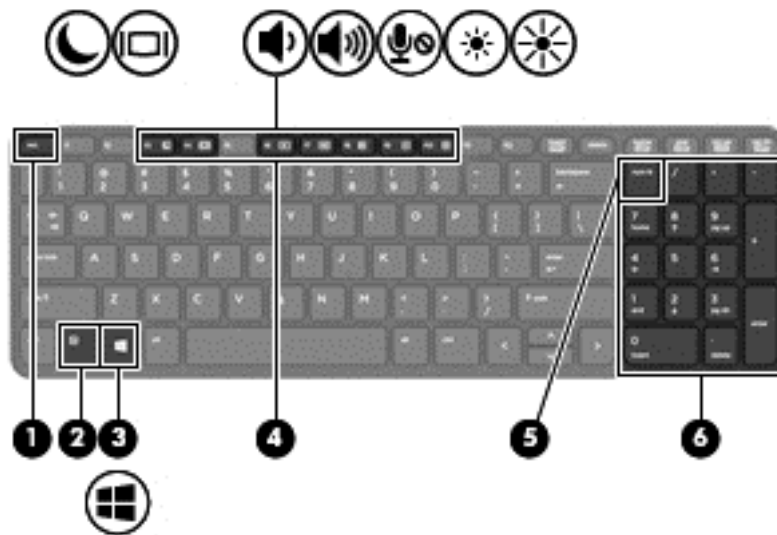

Component	Description
(1) esc key	Displays system information when pressed in combination with the fn key. NOTE: Not applicable to SLED.
(2) fn key	Executes frequently used system functions when pressed in combination with a function key, the num lk key, or the esc key.
(3)  Windows 7/8: Windows button SLED: Operating system logo key	Windows 8: Returns you to the Start screen from an open app or the Windows desktop. NOTE: Pressing the Windows button again will return you to the previous screen. Windows 7: Displays the Windows Start menu. SLED: Displays the operating system menu.
(4) Function keys	Execute frequently used system functions when pressed in combination with the fn key.
(5) num lk key	Turns the embedded numeric keypad on and off when pressed in combination with the fn key. Alternates between the navigational and numeric functions on the integrated numeric keypad.
(6) Integrated numeric keypad	When num lk has been enabled, it can be used like an external numeric keypad.





Front

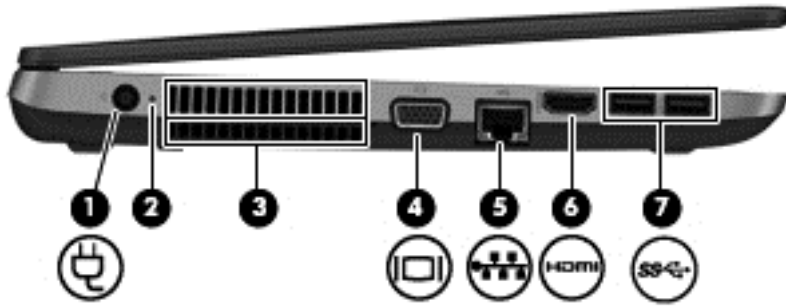

Component	Description
(1)  Hard drive light	<ul style="list-style-type: none">• Blinking white: The hard drive is being accessed.• Amber: HP 3D DriveGuard has temporarily parked the hard drive.
(2) Media Card Reader	Reads data from and writes data to digital memory cards such as Secure Digital (SD).





Left

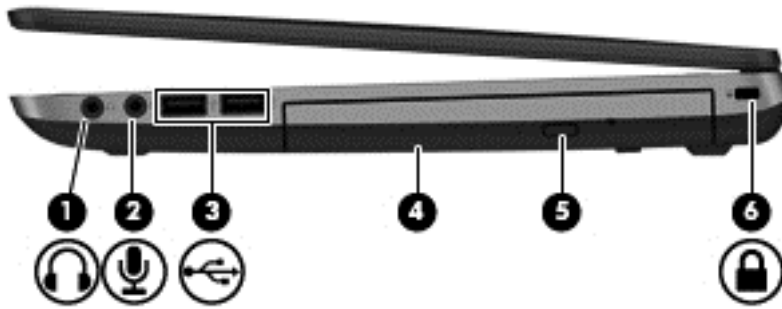

Component	Description
(1) 	Power connector Connects an AC adapter.
(2) AC adapter/Battery light	<ul style="list-style-type: none"> White: The computer is connected to external power and the battery is charged from 90 to 99 percent. Amber: The computer is connected to external power and the battery is charged from 0 to 89 percent. Blinking amber: A battery that is the only available power source has reached a low battery level. When the battery reaches a critical battery level, the battery light begins blinking rapidly. Off: The battery is fully charged.
(3) Vents (2)	Enables airflow to cool internal components. NOTE: The computer fan starts up automatically to cool internal components and prevent overheating. It is normal for the internal fan to cycle on and off during routine operation.
(4)  External monitor port	Connects an external VGA monitor or projector.
(5)  RJ-45 (network) jack RJ-45 (network) lights (2)	Connects a network cable. <ul style="list-style-type: none"> Green (left): The network is connected. Amber (right): The network is showing activity.
(6)  HDMI port	Connects an optional video or audio device, such as a high-definition television, or any compatible digital or audio component.
(7)  USB 3.0 ports (2)	Connect optional USB 3.0 devices and provide enhanced USB power performance.

Right



Component	Description
(1)  Audio-out (headphone) jack	<p>Produces sound when connected to optional powered stereo speakers, headphones, earbuds, a headset, or television audio.</p> <p>WARNING! To reduce the risk of personal injury, adjust the volume before putting on headphones, earbuds, or a headset. For additional safety information, see the <i>Regulatory, Safety, and Environmental Notices</i>. To access the user guides in Windows 8, select the HP Support Assistant app on the Start screen, select My computer, and then select User guides.</p> <p>NOTE: When a device is connected to the jack, the computer speakers are disabled.</p>
(2)  Audio-in (microphone) jack	Connects an optional computer headset microphone, stereo array microphone, or monaural microphone.
(3)  USB 2.0 ports (2)	Connect optional USB devices.
(4) Optical drive (select models only)	Reads and writes (select models only) to an optical disc.
(5) Optical drive eject button (select models only)	Releases the optical drive disc tray.
(6)  Security cable slot	<p>Attaches an optional security cable to the computer.</p> <p>NOTE: The security cable is designed to act as a deterrent, but it may not prevent the computer from being mishandled or stolen.</p>

Service tag and PCID label

Service tag

When ordering parts or requesting information, provide the computer serial number and model description provided on the service tag.

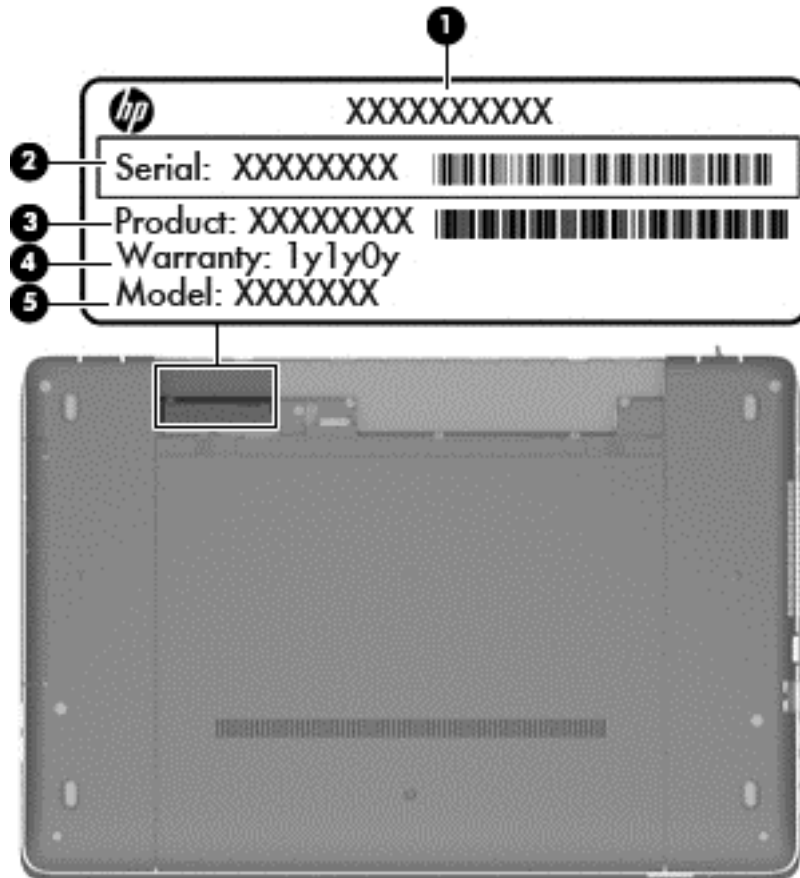

- Product name **(1)**. This is the product name affixed to the front of the computer.
- Serial number (s/n) **(2)**. This is an alphanumeric identifier that is unique to each product.
- Part number/Product number (p/n) **(3)**. This number provides specific information about the product's hardware components. The part number helps a service technician to determine what components and parts are needed.
- Warranty period **(4)**. This number describes the duration (in years) of the warranty period for the computer.
- Model description (select models only) **(5)**. This is the alphanumeric identifier used to locate documents, drivers, and support for the computer.

PCID label

The PCID label provides the information required to properly reset the notebook firmware (BIOS) back to factory shipped specifications when replacing the system board. The label may have a different number of characters depending on the operating system on the computer.

 **NOTE:** Computer details may vary from images.

Windows 8 models

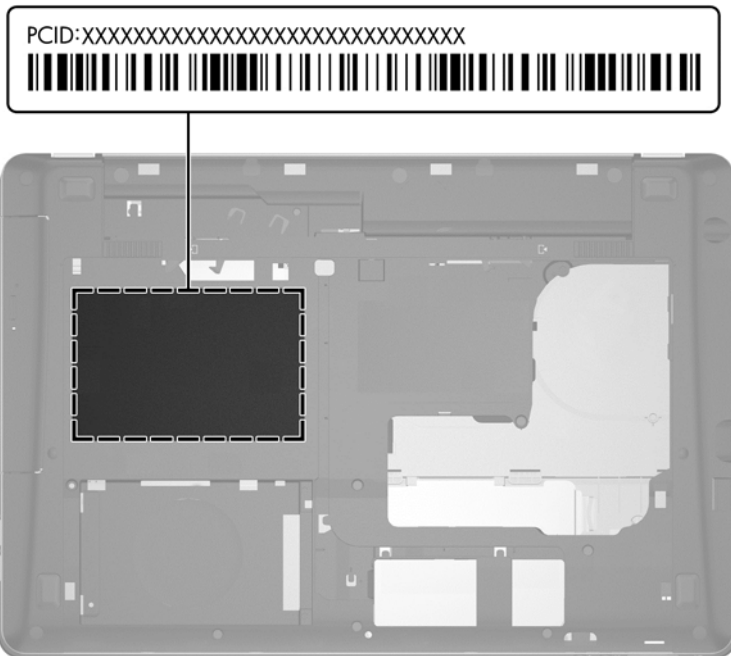

Non-Windows 8 models

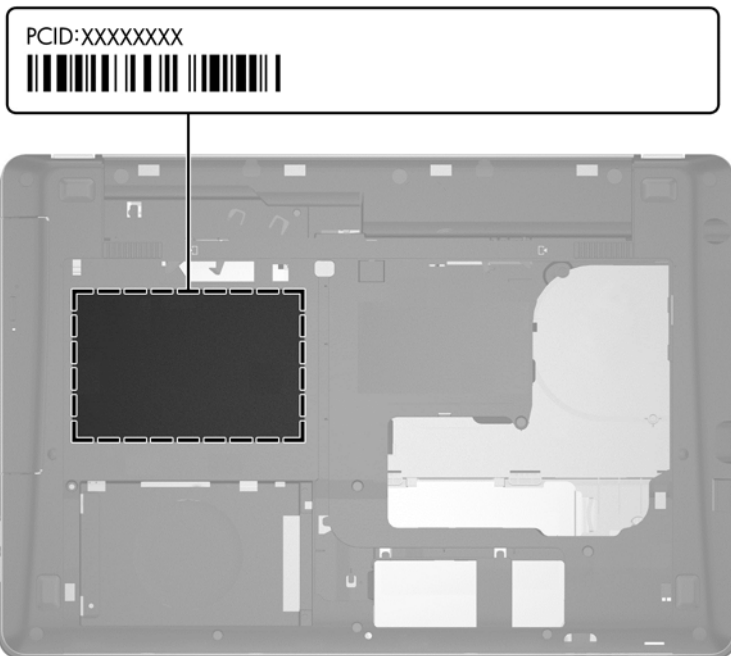

3 Illustrated parts catalog

Computer major components

 **NOTE:** Details about your computer, including model, serial number, product key, and length of warranty, are on the service tag at the bottom of your computer. See [Service tag and PCID label on page 16](#) for details.

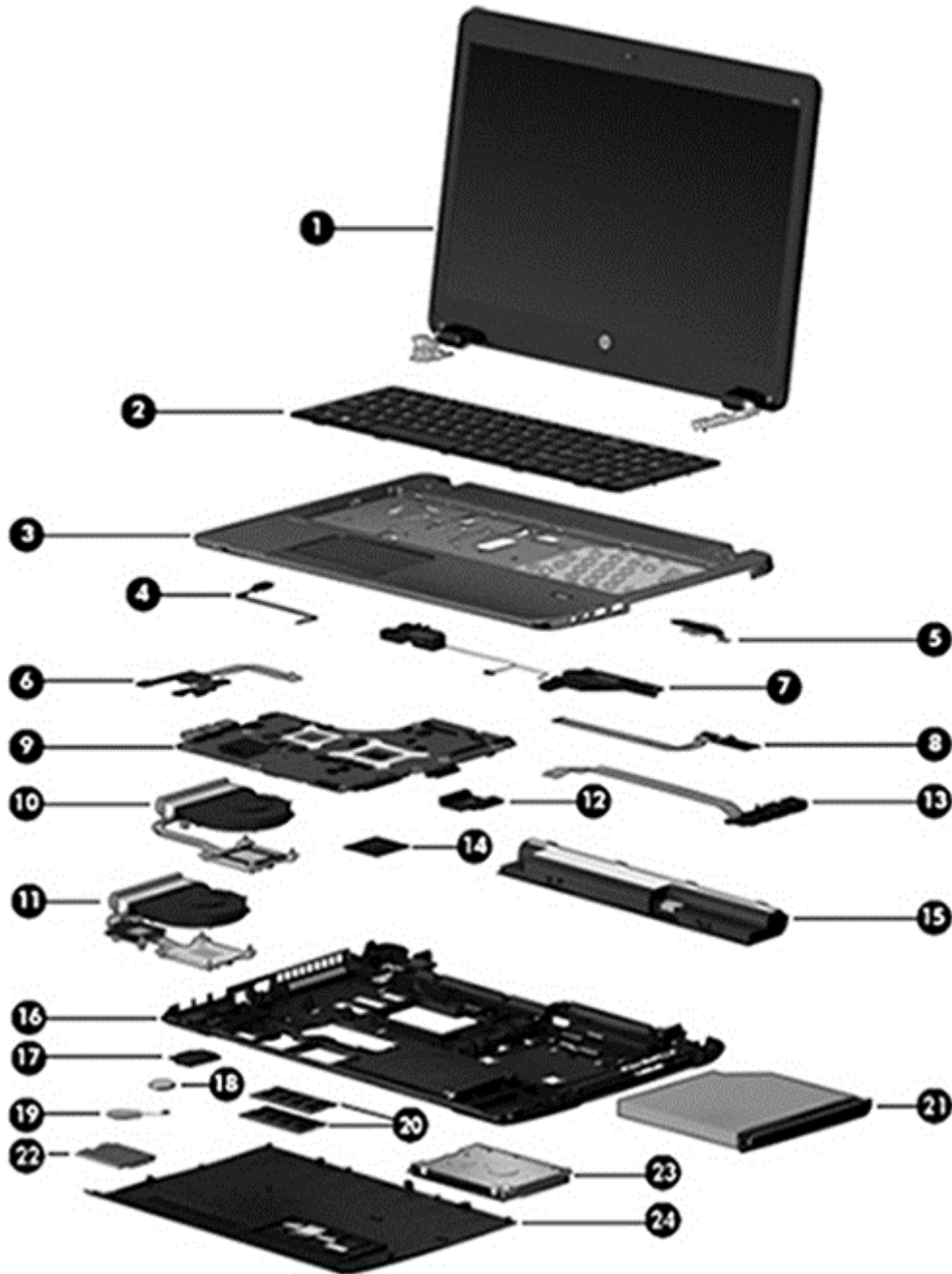

Item	Description	Spare part number
(1)	Display panel , 39.6-cm (15.6-inch), HD, anti-glare	
	For use in Intel models:	
	For use in models without a webcam and without WWAN	721941-001
	For use in models with a webcam and with WWAN	721942-001
	For use in models with a webcam and without WWAN	724940-001
	For use in touchscreen models	724941-001
	For use in AMD models:	
	For use in models with a webcam	724942-001
	For use in models without a webcam	722816-001
(2)	Keyboard (includes cable)	721953-xxx
	NOTE: For a detailed list of available keyboards, see Sequential part number listing on page 27 .	
(3)	Top cover (includes touchpad assembly)	
	With a fingerprint reader (includes fingerprint reader assembly)	721951-001
	Without a fingerprint reader (includes fingerprint reader plastic insert, bracket, and screws)	721952-001
(4)	Power button board assembly	721531-001
(5)	Function board	721943-001
(6)	Card reader board	721535-001
(7)	Speaker assembly	721950-001
(8)	Fingerprint reader assembly (includes cable, bracket, holder, and screws)	721939-001
(9)	System board (includes replacement thermal material)	
	Intel models:	
	• Non-Windows 8 with 1-GB discrete graphics memory	721521-001
	• Non-Windows 8 with 2-GB discrete graphics memory	721522-001
	• Non-Windows 8, UMA graphics memory without WWAN	721523-001
	• Non-Windows 8, UMA graphics memory with WWAN	721525-001
	• Windows 8 Standard with 1-GB discrete graphics memory	721521-501
	• Windows 8 Professional with 1-GB discrete graphics memory	721521-601
	• Windows 8 Standard with 2-GB discrete graphics memory	721522-501
	• Windows 8 Professional with 2-GB discrete graphics memory	721522-601
	• Windows 8 Standard with UMA graphics and without WWAN	721523-501
	• Windows 8 Professional with UMA graphics and without WWAN	721523-601
	• Windows 8 Standard with UMA graphics and with WWAN	721525-501
	• Windows 8 Professional with UMA graphics and with WWAN	721525-601
	AMD models:	

Item	Description	Spare part number
	<ul style="list-style-type: none"> Non-Windows 8 with 1-GB discrete graphics memory 	722818-001
	<ul style="list-style-type: none"> Non-Windows 8 with 2-GB discrete graphics memory 	722821-001
	<ul style="list-style-type: none"> Non-Windows 8 with UMA graphics 	722824-001
	<ul style="list-style-type: none"> Windows 8 Standard with 1-GB discrete graphics memory 	722818-501
	<ul style="list-style-type: none"> Windows 8 Professional with 1-GB discrete graphics memory 	722818-601
	<ul style="list-style-type: none"> Windows 8 Standard with 2-GB discrete graphics memory 	722821-501
	<ul style="list-style-type: none"> Windows 8 Professional with 2-GB discrete graphics memory 	722821-601
	<ul style="list-style-type: none"> Windows 8 Standard with UMA graphics 	722824-501
	<ul style="list-style-type: none"> Windows 8 Professional with UMA graphics 	722824-601
	Fan/heat sink assembly (includes replacement thermal material)	
(10)	For use in models with UMA graphics	721938-001
(11)	For use in models with discrete graphics	721937-001
(12)	Optical drive extension board	721944-001
(13)	USB/audio board	721542-001
(14)	Processor (includes thermal material)	
	Intel models:	
	<ul style="list-style-type: none"> Intel Core i7 3632QM, 2.2-GHz with 6-MB L3 cache 	701658-001
	<ul style="list-style-type: none"> Intel Core i5 3380M, 2.9-GHz with 3-MB L3 cache 	708762-001
	<ul style="list-style-type: none"> Intel Core i5 3340M, 2.7-GHz with 3-MB L3 cache 	708761-001
	<ul style="list-style-type: none"> Intel Core i5 3230M, 2.6-GHz with 3-MB L3 cache 	711903-001
	<ul style="list-style-type: none"> Intel Core i3 3130M, 2.6-GHz with 3-MB L3 cache 	713163-001
	<ul style="list-style-type: none"> Intel Core i3 3120M, 2.5-GHz with 3-MB L3 cache 	700627-001
	<ul style="list-style-type: none"> Intel Pentium 2020M, 2.4-GHz with 2-MB L3 cache 	700628-001
	<ul style="list-style-type: none"> Intel Celeron 1000M, 1.8-GHz with 2-MB L3 cache 	713162-001
	AMD models:	
	<ul style="list-style-type: none"> A8-5550M, 3.1-GHz/2.1-GHz, 4-MB L2 cache, HD 8550G graphics 	713551-001
	<ul style="list-style-type: none"> A8-4500M, 2.8-GHz/1.9-GHz, 4-MB L2 cache, HD 7640G graphics 	683048-001
	<ul style="list-style-type: none"> A6-5350M, 3.5-GHz/2.9-GHz, 1-MB L2 cache, HD 8450G graphics 	713550-001
	<ul style="list-style-type: none"> A6-4400M, 3.2-GHz/2.7-GHz, 1-MB L2 cache, HD 7520G graphics 	683047-001
	<ul style="list-style-type: none"> A4-5150M, 3.3-GHz/2.7-GHz, 1-MB L2 cache, HD 8350G graphics 	713549-001
	<ul style="list-style-type: none"> A4-4300M, 3.0-GHz/2.5-GHz, 1-MB L2 cache, HD 7420G graphics 	685990-001
(15)	Battery, Li-ion	
	9-cell (93 WHr, 2.8 Ah)	708458-001
	6-cell (47 WHr, 2.2 Ah)	708457-001

Item	Description	Spare part number
(16)	Base enclosure	721933-001
(17)	WLAN module	
	Intel Centrino Advanced-N 6235	670292-001
	Atheros AR9485 802.11b/g/n 1x1 WiFi Adapter	675794-001
	Atheros AR9565 802.11bgn 1x1 WiFi + BT4.0 combo Adapter	690019-001
	Ralink RT3290LE 802.11bgn 1x1 Wi-Fi and Bluetooth 4.0 Combo Adapter	690020-001
	Realtek RTL8188EE 802.11bgn Wi-Fi Adapter	709848-001
	Broadcom BCM943228HMB 802.11abgn 2x2 Wi-Fi + BT 4.0 Combo Adapter (Intel models only)	731550-001
	RTC battery	
(18)	For use in models with Intel processors	721532-001
(19)	For use in models with AMD processors	683601-001
(20)	Memory modules (PC3L-12800, 1600-MHz, DDR3L)	
	8-GB	693374-001
	4-GB	691740-001
	2-GB	691739-001
(21)	Optical drive (includes bracket, bezel, and screws)	
	Blu-ray ROM DVD±RW SuperMulti DL Drive (Intel models only)	722828-001
	DVD±RW SuperMulti DL Drive	722830-001
	DVD-ROM drive	722829-001
(22)	WWAN module	
	HP lt4112 LTE/HSPA+ Gobi 4G Module	704031-001
	HP hs3110 HSPA+ Mobile Broadband Module	723895-001
(23)	Hard drive	
	1-TB, 5400-rpm (Intel models only)	676521-001
	750-GB, 5400-rpm	634250-001
	500-GB, 7200-rpm	703267-001
	500-GB, 5400-rpm,	683802-001
	500-GB, 5400-rpm, hybrid (8-GB SSD) (Intel models only)	732000-001
	320-GB, 5400-rpm	645193-001
	128-GB Solid-state drive (SSD) (Intel models only)	733983-001
(24)	Service door	721946-001

Display components

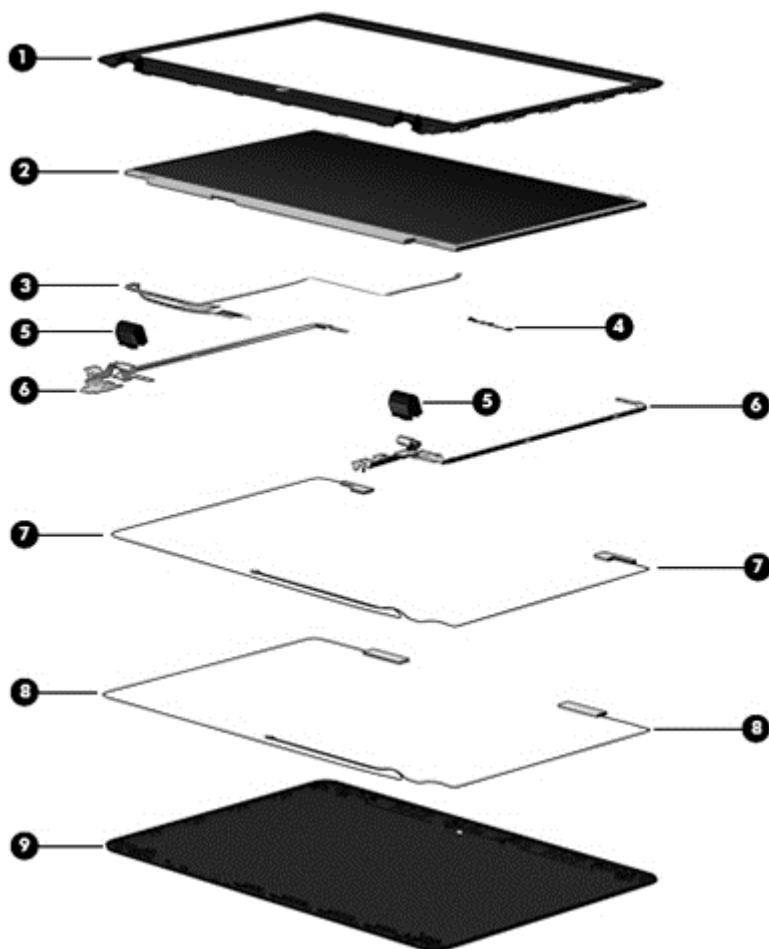

Item	Description	Spare part number
(1)	Display bezel	
	For use in models with a webcam	721934-001
	For use in models without a webcam	721935-001
(2)	Display panel (raw)	not spared
(3)	Display/webcam cable assembly	721936-001 (in Cable Kit)
(4)	Webcam module for use in all models	721543-001
	Microphone module ; not illustrated	721526-001
	Display Hinge Kit	721940-001
(5)	Display hinge covers	
(6)	Display hinges (left and right)	
(7)	WLAN antennas	721930-001

Item	Description	Spare part number
(8)	WWAN antennas	721931-001
(9)	Display rear cover	721932-001

Plastics Kit



Item	Description	Spare part number
	Plastics Kit	721945-001
(1)	Optical drive protective insert	

Cable Kit

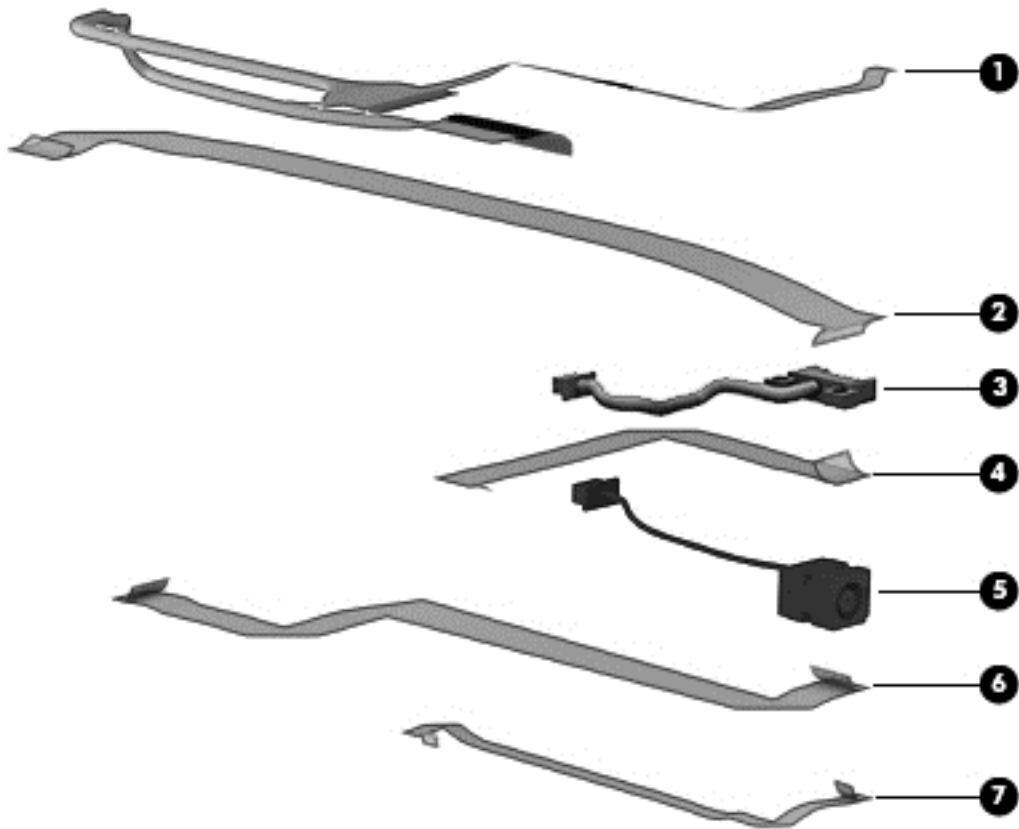

Item	Description	Spare part number
	Cable Kit	721936-001
(1)	Display/webcam cable	
(2)	USB/audio board connector cable	
(3)	Battery connector cable	
(4)	Card reader cable	
(5)	Power connector cable	
(6)	Function board connector cable	
(7)	Power button board cable	

Mass storage devices

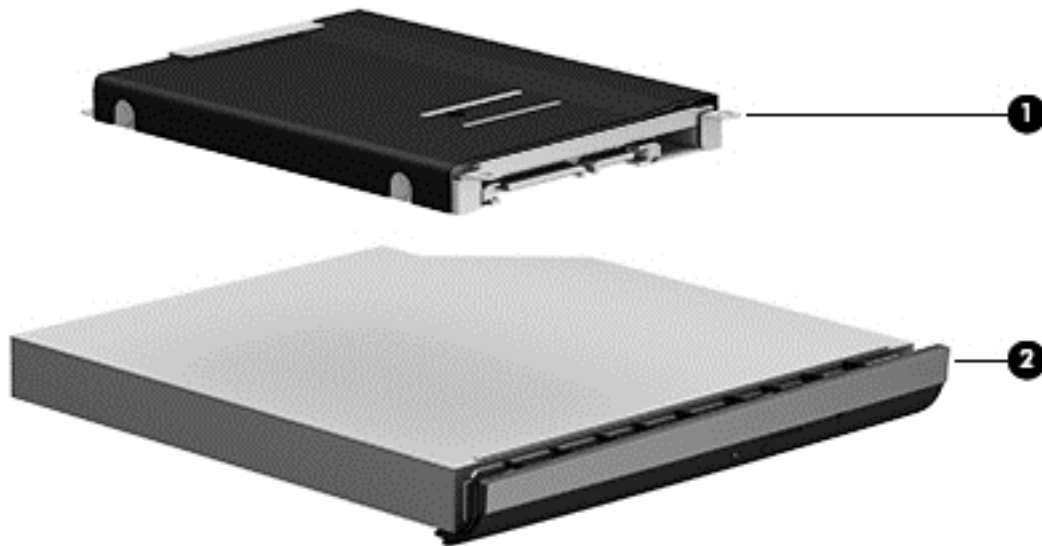

	Description	Spare part number
(1)	Hard drives	
	1-TB, 5400-rpm (Intel models only)	676521-001
	750-GB, 5400-rpm	634250-001
	500-GB, 7200-rpm	703267-001
	500-GB, 5400-rpm	683802-001
	500-GB, 5400-rpm, hybrid (8-GB SSD) (Intel models only)	732000-001
	320-GB, 5400-rpm	645193-001
	128-GB Solid-state drive (SSD) (Intel models only)	733983-001
	Hard Drive Hardware Kit (includes hard drive bracket and screws; not illustrated)	721519-001
(2)	Optical drives (include bezel, bracket, and screws)	
	Blu-ray ROM DVD±RW SuperMulti DL Drive (Intel models only)	722828-001
	DVD±RW SuperMulti DL Drive	722830-001
	DVD-ROM drive	722829-001

Miscellaneous parts

Description	Spare part number
AC adapters	
90-W AC adapter	693712-001
90-W AC adapter for use in India	693713-001
65-W AC adapter	693711-001
65-W AC adapter for use in India	693710-001
Power cords:	
For use in Argentina	490371-D01
For use in Denmark	490371-081
For use in Europe, the Middle East, and Africa	490371-021
For use in Israel	490371-BB1
For use in Italy	490371-061
For use in South Africa	490371-AR1
For use in Switzerland	490371-111
For use in Thailand	490371-201
For use in the United Kingdom	490371-031
For use in the United States	490371-001
Rubber Kit (includes rubber base enclosure screw covers and mylar display bezel screw covers)	721948-001
Screw Kit	721534-001

Sequential part number listing

CSR flag designations:

A = Mandatory

B = Optional

C = Service technician recommended

N = Non-user replaceable

Spare part number	CSR flag	Description
490371-001	A	Power cord for use in North America
490371-021	A	Power cord for use in Europe, the Middle East, and Africa
490371-031	A	Power cord for use in the United Kingdom
490371-061	A	Power cord for use in Italy
490371-081	A	Power cord for use in Denmark
490371-111	A	Power cord for use in Switzerland
490371-201	A	Power cord for use in Thailand
490371-AR1	A	Power cord for use in South Africa
490371-BB1	A	Power cord for use in Israel
490371-D01	A	Power cord for use in Argentina
634250-001	A	750-GB, 5400-rpm hard drive
645193-001	A	320-GB, 5400-rpm hard drive
670292-001	A	Intel Centrino Advanced-N 6235 WLAN card
675794-001	A	Atheros AR9485 802.11b/g/n 1x1 WiFi Adapter
676521-001	A	1-TB, 5400-rpm hard drive (Intel models only)
683047-001	N	AMD A6-4400M processor, 3.2-GHz/2.7-GHz, 1-MB L2 cache, HD 7520G graphics
683048-001	N	AMD A8-4500M processor, 2.8-GHz/1.9-GHz, 4-MB L2 cache, HD 7640G graphics
683601-001	N	RTC battery for use in models with AMD processors
683802-001	A	500-GB, 5400-rpm hard drive
685990-001	N	AMD A4-4300M processor, 3.0-GHz/2.5-GHz, 1-MB L2 cache, HD 7420G graphics
690019-001	A	Atheros AR9565 802.11bgn 1x1 WiFi + BT4.0 combo Adapter
690020-001	A	Ralink RT3290LE 802.11bgn 1x1 Wi-Fi and Bluetooth 4.0 Combo Adapter
691739-001	A	2-GB memory module (PC3L-12800, 1600-MHz, DDR3L)
691740-001	A	4-GB memory module (PC3L-12800, 1600-MHz, DDR3L)
693374-001	A	8-GB memory module (PC3L-12800, 1600-MHz, DDR3L)
693710-001	A	65-W AC adapter for use in India
693711-001	A	65-W AC adapter

Spare part number	CSR flag	Description
693712-001	A	90-W AC adapter
693713-001	A	90-W AC adapter for use in India
700627-001	N	Intel Core i3 processor, 3120M, 2.5-GHz, 3-MB L3 cache (includes thermal material)
700628-001	N	Intel Pentium 2020M processor, 2.4-GHz, 2-MB L3 cache (includes thermal material)
701658-001	N	Intel Core i7 processor, 3632QM, 2.2-GHz, 6-MB L3 cache (include thermal material)
703267-001	A	500-GB, 7200-rpm hard drive
704031-001	A	HP lt4112 LTE/HSPA+ Gobi 4G Module (WWAN module)
708457-001	A	6-cell, 47 WHr, 2.2 Ah Li-ion battery
708458-001	A	9-cell, 93 WHr, 2.8 Ah Li-ion battery
708761-001	N	Intel Core i5 processor, 3340M, 2.7-GHz, 3-MB L3 cache (include thermal material)
708762-001	N	Intel Core i5 processor, 3380M, 2.9-GHz, 3-MB L3 cache (include thermal material)
709848-001	A	Realtek RTL8188EE 802.11bgn Wi-Fi Adapter
711903-001	N	Intel Core i5 processor, 3230M, 2.6-GHz, 3-MB L3 cache (includes thermal material)
713162-001	N	Intel Celeron 1000M processor, 1.8-GHz processor, 3-MB L3 cache (includes thermal material)
713163-001	N	Intel Core i3 processor, 3130M, 2.6-GHz, 3-MB L3 cache (includes thermal material)
713549-001	N	AMD A4-5150M processor, 3.3-GHz/2.7-GHz, 1-MB L2 cache, HD 8350G graphics
713550-001	N	AMD A6-5350M processor, 3.5-GHz/2.9-GHz, 1-MB L2 cache, HD 8450G graphics
713551-001	N	AMD A8-5550M processor, 3.1-GHz/2.1-GHz, 4-MB L2 cache, HD 8550G graphics
721930-001	N	WLAN antennas
721931-001	N	WWAN antennas
721933-001	N	Base enclosure
721936-001	N	Cable Kit (see Cable Kit on page 24 for more Cable Kit spare part information)
721932-001	C	Display rear cover
721934-001	B	Display bezel for use in models with a webcam
721935-001	B	Display bezel for use in models without a webcam
721940-001	C	Display Hinge Kit (includes left and right hinges and hinge covers)
721941-001	B	39.6-cm (15.6-inch), display assembly, HD, anti-glare, for use in Intel models without a webcam and without WWAN
721942-001	B	39.6-cm (15.6-inch), display assembly, HD, anti-glare, for use in Intel models with a webcam and with WWAN
721939-001	B	Fingerprint reader assembly (includes cable, bracket, holder, and screws)
721943-001	B	Function board
721519-001	A	Hard Drive Hardware Kit (includes bracket and screws)
721953-001	A	Keyboard for use in the United States

Spare part number	CSR flag	Description
721953-031	A	Keyboard for use in the United Kingdom
721953-041	A	Keyboard for use in Germany
721953-051	A	Keyboard for use in France
721953-061	A	Keyboard for use in Italy
721953-071	A	Keyboard for use in Spain
721953-081	A	Keyboard for use in Denmark
721953-091	A	Keyboard for use in Norway
721953-131	A	Keyboard for use in Portugal
721953-141	A	Keyboard for use in Turkey
721953-151	A	Keyboard for use in Greece
721953-171	A	Keyboard for use in Saudi Arabia
721953-211	A	Keyboard for use in Hungary
721953-251	A	Keyboard for use in Russia
721953-261	A	Keyboard for use in Bulgaria
721953-271	A	Keyboard for use in Romania
721953-281	A	Keyboard for use in Thailand
721953-291	A	Keyboard for use in Japan
721953-AB1	A	Keyboard for use in Taiwan
721953-AD1	A	Keyboard for use in South Korea
721953-B31	A	Keyboard for use in the Netherlands and Europe
721953-B71	A	Keyboard for use in Sweden and Finland
721953-BA1	A	Keyboard for use in Slovenia
721953-BB1	A	Keyboard for use in Israel
721953-BG1	A	Keyboard for use in Switzerland
721953-D61	A	Keyboard for use in India
721953-DD1	A	Keyboard for use in Iceland
721953-DH1	A	Keyboard for use in the Netherlands
721953-FL1	A	Keyboard for use in the Czech Republic and Slovakia
721953-FP1	A	Keyboard for use in northern Africa
721521-001	N	System board for use in Intel models without Windows 8 with 1-GB discrete graphics (includes thermal material)
721521-501	N	System board for use in Intel models with Windows 8 Standard and 1-GB discrete graphics (includes thermal material)
721521-601	N	System board for use in Intel models with Windows 8 Professional and 1-GB discrete graphics (includes thermal material)

Spare part number	CSR flag	Description
721522-001	N	System board for use in Intel models without Windows 8 and 2-GB discrete graphics (includes thermal material)
721522-501	N	System board for use in Intel models with Windows 8 Standard and 2-GB discrete graphics (includes thermal material)
721522-601	N	System board for use in Intel models with Windows 8 Professional and 2-GB discrete graphics (includes thermal material)
721523-001	N	System board for use in Intel models without Windows 8, with UMA graphics, and without WWAN
721523-501	N	System board for use in Intel models, with Windows 8 Standard, UMA graphics, and without WWAN
721523-601	N	System board for use in Intel models, with Windows 8 Professional, UMA graphics, and without WWAN
721525-001	N	System board for use in Intel models, without Windows 8, with UMA graphics, and with WWAN
721525-501	N	System board for use in Intel models, with Windows 8 Standard, UMA graphics, and with WWAN
721525-601	N	System board for use in Intel models, with Windows 8 Professional, UMA graphics, and with WWAN
721526-001	B	Microphone module
721944-001	B	Optical drive extension board
722828-001	A	Blu-ray ROM DVD±RW SuperMulti DL Drive for use only in Intel models (includes bezel, bracket, and screws)
722829-001	A	DVD-ROM drive (includes bezel, bracket, and screws)
722830-001	A	DVD±RW SuperMulti DL Drive (includes bezel, bracket, and screws)
721945-001	N	Plastics Kit (includes optical drive protective insert and Secure Digital card protective insert)
721531-001	B	Power button board
721532-001	N	RTC battery for use in models with Intel processors
721948-001	A	Rubber Kit (includes rubber base enclosure screw covers and mylar display bezel screw covers)
721534-001	N	Screw Kit
721535-001	B	Card reader board
721946-001	A	Service door
721950-001	B	Speaker assembly
721937-001	N	Fan/heat sink assembly for use in models with discrete graphics (includes replacement thermal material)
721938-001	N	Fan/heat sink assembly for use in models with UMA graphics (includes replacement thermal material)
721951-001	B	Top cover for use in models with a fingerprint reader (includes fingerprint reader board and touchpad assembly)
721952-001	B	Top cover for use in models without a fingerprint reader (includes touchpad assembly, fingerprint reader plastic insert, bracket, and screws)
721542-001	B	USB/audio board
721543-001	B	Webcam module
722816-001	B	39.6-cm (15.6-inch), display assembly, HD, anti-glare, for use in AMD models without a webcam

Spare part number	CSR flag	Description
722818-001	N	System board for use in AMD models without Windows 8 with 1-GB discrete graphics (includes thermal material)
722818-501	N	System board for use in AMD models with Windows 8 Standard and 1-GB discrete graphics (includes thermal material)
722818-601	N	System board for use in AMD models with Windows 8 Professional and 1-GB discrete graphics (includes thermal material)
722821-001	N	System board for use in AMD models without Windows 8 with 2-GB discrete graphics (includes thermal material)
722821-501	N	System board for use in AMD models with Windows 8 Standard and 2-GB discrete graphics (includes thermal material)
722821-601	N	System board for use in AMD models with Windows 8 Professional and 2-GB discrete graphics (includes thermal material)
722824-001	N	System board for use in AMD models without Windows 8 with UMA graphics (includes thermal material)
722824-501	N	System board for use in AMD models with Windows 8 Standard and UMA graphics (includes thermal material)
722824-601	N	System board for use in AMD models with Windows 8 Professional and UMA graphics (includes thermal material)
724942-001	B	39.6-cm (15.6-inch), display assembly, HD, anti-glare, for use in AMD models with a webcam
723895-001	A	HP hs3110 HSPA+ Mobile Broadband Module
724940-001	B	39.6-cm (15.6-inch), display assembly, HD, anti-glare, for use in Intel models with a webcam and without WWAN
724941-001	B	39.6-cm (15.6-inch) touchscreen display assembly for use in Intel models
731550-001	A	Broadcom BCM943228HMB 802.11abgn 2x2 Wi-Fi + BT 4.0 Combo Adapter (Intel models only)
732000-001	A	500-GB, 5400-rpm, hybrid (8-GB SSD) hard drive (Intel models only)
733983-001	A	128-GB Solid-state drive (SSD) (Intel models only)

4 Removal and replacement procedures preliminary requirements

Tools required

You will need the following tools to complete the removal and replacement procedures:

- Flat-bladed screwdriver
- Phillips P0 and P1 screwdrivers
- Torx T8 screwdriver

Service considerations

The following sections include some of the considerations that you must keep in mind during disassembly and assembly procedures.



NOTE: As you remove each subassembly from the computer, place the subassembly (and all accompanying screws) away from the work area to prevent damage.

Plastic parts



CAUTION: Using excessive force during disassembly and reassembly can damage plastic parts. Use care when handling the plastic parts. Apply pressure only at the points designated in the maintenance instructions.

Cables and connectors

⚠ CAUTION: When servicing the computer, be sure that cables are placed in their proper locations during the reassembly process. Improper cable placement can damage the computer.

Cables must be handled with extreme care to avoid damage. Apply only the tension required to unseat or seat the cables during removal and insertion. Handle cables by the connector whenever possible. In all cases, avoid bending, twisting, or tearing cables. Be sure that cables are routed in such a way that they cannot be caught or snagged by parts being removed or replaced. Handle flex cables with extreme care; these cables tear easily.

Drive handling

⚠ CAUTION: Drives are fragile components that must be handled with care. To prevent damage to the computer, damage to a drive, or loss of information, observe these precautions:

Before removing or inserting a hard drive, shut down the computer. If you are unsure whether the computer is off or in Hibernation, turn the computer on, and then shut it down through the operating system.

Before handling a drive, be sure that you are discharged of static electricity. While handling a drive, avoid touching the connector.

Before removing a diskette drive or optical drive, be sure that a diskette or disc is not in the drive and be sure that the optical drive tray is closed.

Handle drives on surfaces covered with at least one inch of shock-proof foam.

Avoid dropping drives from any height onto any surface.

After removing a hard drive, an optical drive, or a diskette drive, place it in a static-proof bag.

Avoid exposing a hard drive to products that have magnetic fields, such as monitors or speakers.

Avoid exposing a drive to temperature extremes or liquids.

If a drive must be mailed, place the drive in a bubble pack mailer or other suitable form of protective packaging and label the package "FRAGILE."

Grounding guidelines

Electrostatic discharge damage

Electronic components are sensitive to electrostatic discharge (ESD). Circuitry design and structure determine the degree of sensitivity. Networks built into many integrated circuits provide some protection, but in many cases, ESD contains enough power to alter device parameters or melt silicon junctions.

A discharge of static electricity from a finger or other conductor can destroy static-sensitive devices or microcircuitry. Even if the spark is neither felt nor heard, damage may have occurred.

An electronic device exposed to ESD may not be affected at all and can work perfectly throughout a normal cycle. Or the device may function normally for a while, and then degrade in the internal layers, reducing its life expectancy.

CAUTION: To prevent damage to the computer when you are removing or installing internal components, observe these precautions:

Keep components in their electrostatic-safe containers until you are ready to install them.

Use nonmagnetic tools.

Before touching an electronic component, discharge static electricity by using the guidelines described in this section.

Avoid touching pins, leads, and circuitry. Handle electronic components as little as possible.

If you remove a component, place it in an electrostatic-safe container.

The following table shows how humidity affects the electrostatic voltage levels generated by different activities.

CAUTION: A product can be degraded by as little as 700 V.

Typical electrostatic voltage levels			
Event	Relative humidity		
	10%	40%	55%
Walking across carpet	35,000 V	15,000 V	7,500 V
Walking across vinyl floor	12,000 V	5,000 V	3,000 V
Motions of bench worker	6,000 V	800 V	400 V
Removing DIPS from plastic tube	2,000 V	700 V	400 V
Removing DIPS from vinyl tray	11,500 V	4,000 V	2,000 V
Removing DIPS from Styrofoam	14,500 V	5,000 V	3,500 V
Removing bubble pack from PCB	26,500 V	20,000 V	7,000 V
Packing PCBs in foam-lined box	21,000 V	11,000 V	5,000 V

Packaging and transporting guidelines

Follow these grounding guidelines when packaging and transporting equipment:

- To avoid hand contact, transport products in static-safe tubes, bags, or boxes.
- Protect ESD-sensitive parts and assemblies with conductive or approved containers or packaging.
- Keep ESD-sensitive parts in their containers until the parts arrive at static-free workstations.
- Place items on a grounded surface before removing items from their containers.
- Always be properly grounded when touching a component or assembly.
- Store reusable ESD-sensitive parts from assemblies in protective packaging or nonconductive foam.
- Use transporters and conveyors made of antistatic belts and roller bushings. Be sure that mechanized equipment used for moving materials is wired to ground and that proper materials are selected to avoid static charging. When grounding is not possible, use an ionizer to dissipate electric charges.

Workstation guidelines

Follow these grounding workstation guidelines:

- Cover the workstation with approved static-shielding material.
- Use a wrist strap connected to a properly grounded work surface and use properly grounded tools and equipment.
- Use conductive field service tools, such as cutters, screwdrivers, and vacuums.
- When fixtures must directly contact dissipative surfaces, use fixtures made only of static-safe materials.
- Keep the work area free of nonconductive materials, such as ordinary plastic assembly aids and Styrofoam.
- Handle ESD-sensitive components, parts, and assemblies by the case or PCM laminate. Handle these items only at static-free workstations.
- Avoid contact with pins, leads, or circuitry.
- Turn off power and input signals before inserting or removing connectors or test equipment.

Equipment guidelines

Grounding equipment must include either a wrist strap or a foot strap at a grounded workstation.

- When seated, wear a wrist strap connected to a grounded system. Wrist straps are flexible straps with a minimum of one megohm $\pm 10\%$ resistance in the ground cords. To provide proper ground, wear a strap snugly against the skin at all times. On grounded mats with banana-plug connectors, use alligator clips to connect a wrist strap.
- When standing, use foot straps and a grounded floor mat. Foot straps (heel, toe, or boot straps) can be used at standing workstations and are compatible with most types of shoes or boots. On conductive floors or dissipative floor mats, use foot straps on both feet with a minimum of one megohm resistance between the operator and ground. To be effective, the conductive strips must be worn in contact with the skin.

The following grounding equipment is recommended to prevent electrostatic damage:

- Antistatic tapes
- Antistatic smocks, aprons, and sleeve protectors
- Conductive bins and other assembly or soldering aids
- Nonconductive foam
- Conductive tabletop workstations with ground cords of one megohm resistance
- Static-dissipative tables or floor mats with hard ties to the ground
- Field service kits
- Static awareness labels
- Material-handling packages
- Nonconductive plastic bags, tubes, or boxes
- Metal tote boxes
- Electrostatic voltage levels and protective materials

The following table lists the shielding protection provided by antistatic bags and floor mats.

Material	Use	Voltage protection level
Antistatic plastic	Bags	1,500 V
Carbon-loaded plastic	Floor mats	7,500 V
Metallized laminate	Floor mats	5,000 V

5 Removal and replacement procedures for Customer Self-Repair parts

 **CAUTION:** The Customer Self-Repair program is not available in all locations. Installing a part not supported by the Customer Self-Repair program may void your warranty. Check your warranty to determine if Customer Self-Repair is supported in your location.

Component replacement procedures

 **NOTE:** Please read and follow the procedures described here to access and replace Customer Self-Repair parts successfully.

 **NOTE:** Details about your computer, including model, serial number, product key, and length of warranty, are on the service tag at the bottom of your computer. See [Service tag and PCID label on page 16](#) for details.

This chapter provides removal and replacement procedures for Customer Self-Repair parts.

There are as many as 14 screws that must be removed, replaced, or loosened when servicing Customer Self-Repair parts. Make special note of each screw size and location during removal and replacement.

Battery

Description	Spare part number
9-cell, 93 WHr, 2.8 Ah Li-ion battery	708458-001
6-cell, 47 WHr, 2.2 Ah Li-ion battery	708457-001

Before removing the battery, follow these steps:

1. Shut down the computer. If you are unsure whether the computer is off or in Hibernation, turn the computer on, and then shut it down through the operating system.
2. Disconnect all external devices connected to the computer.
3. Disconnect the power from the computer by first unplugging the power cord from the AC outlet, and then unplugging the AC adapter from the computer.

To remove the battery:

CAUTION: Removing a battery that is the sole power source for the computer can cause loss of information. To prevent loss of information, save your work and shut down the computer through Windows before removing the battery.

1. Turn the computer upside down on a flat surface.
2. Slide the battery release latches **(1)** to release the battery.

NOTE: You can slide the battery release latches simultaneously or you can slide them one at a time.

3. Tilt the battery upward **(2)** and remove it from the computer.



Service door

Remove the service door to access the memory module slot, hard drive, and other components.

Before removing the service door, follow these steps:

1. Shut down the computer. If you are unsure whether the computer is off or in Hibernation, turn the computer on, and then shut it down through the operating system.
2. Disconnect all external devices connected to the computer.
3. Disconnect the power from the computer by first unplugging the power cord from the AC outlet, and then unplugging the AC adapter from the computer.
4. Remove the battery (see [Battery on page 38](#)).

To remove the service door:

1. With the battery bay toward you, remove the optional security screw **(1)**, (if the optional security screw is being used, see [Using the optional security screw on page 40](#)), and then slide the service door release latches **(2)** to release the service door.



NOTE: If you do not want to use the optional security screw, you can store it inside the battery bay.

2. Slide the service door toward the front of the computer **(3)** and lift **(4)** to remove the service door.

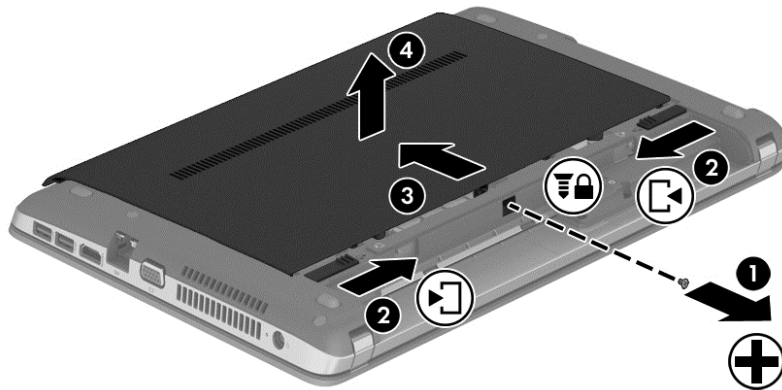

Using the optional security screw

Use the optional security screw to lock the service door to the bottom of the computer. When not in use the security screw can be stored inside the battery bay.

To use the security screw:

1. Remove the battery (see [Battery on page 38](#)).
2. Remove the security screw from inside the battery bay (1) and insert it (2) to lock the service door in place.

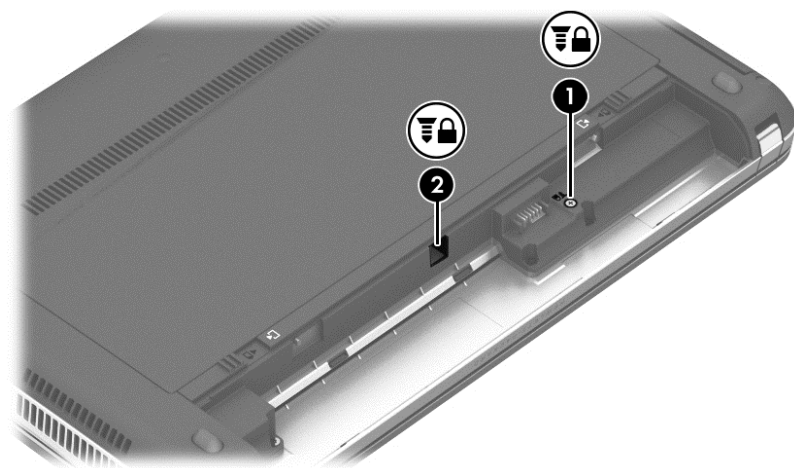

Hard drive

Description	Spare part number
1-TB, 5400-rpm (Intel models only)	676521-001
750-GB, 5400-rpm	634250-001
500-GB, 7200-rpm	703267-001
500-GB, 5400-rpm	683802-001
500-GB, 5400-rpm, hybrid (8-GB SSD) (Intel models only)	732000-001
320-GB, 5400-rpm	645193-001
128-GB Solid-state drive (SSD) (Intel models only)	733983-001

Before removing the hard drive, follow these steps:

1. Shut down the computer. If you are unsure whether the computer is off or in Hibernation, turn the computer on, and then shut it down through the operating system.
2. Disconnect all external devices connected to the computer.
3. Disconnect the power from the computer by first unplugging the power cord from the AC outlet, and then unplugging the AC adapter from the computer.
4. Remove the battery (see [Battery on page 38](#)).
5. Remove the service door (see [Service door on page 39](#)).

To remove a hard drive:

1. Position the computer upside down on a flat surface.
2. Remove the 4 Phillips PM2.5×3.0 screws that secure the hard drive to the chassis.

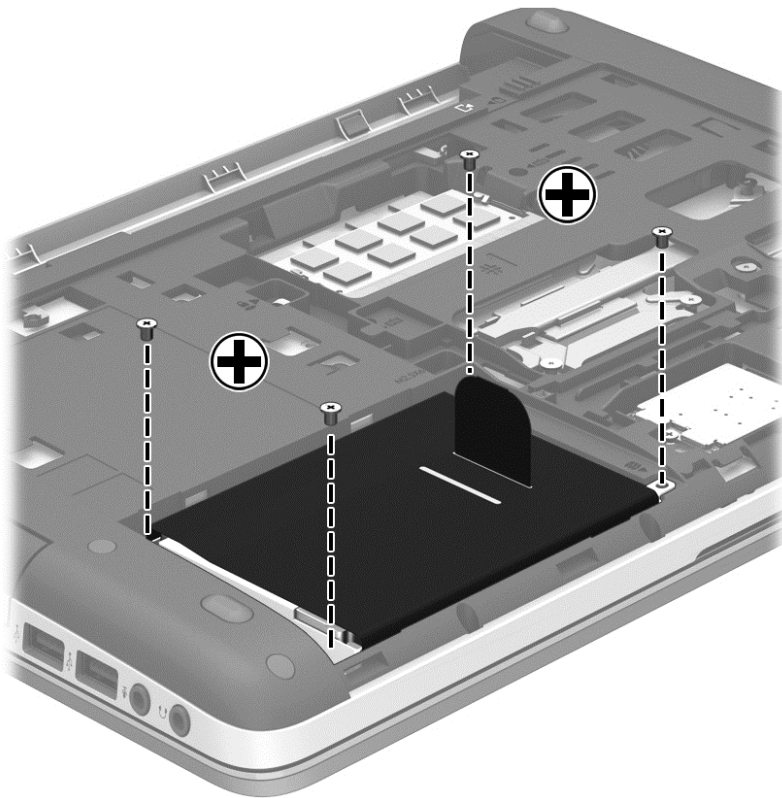

3. Pull the hard drive tab **(1)** toward the side of the computer to disconnect the hard drive.
4. Lift the hard drive **(2)** out of the hard drive bay.

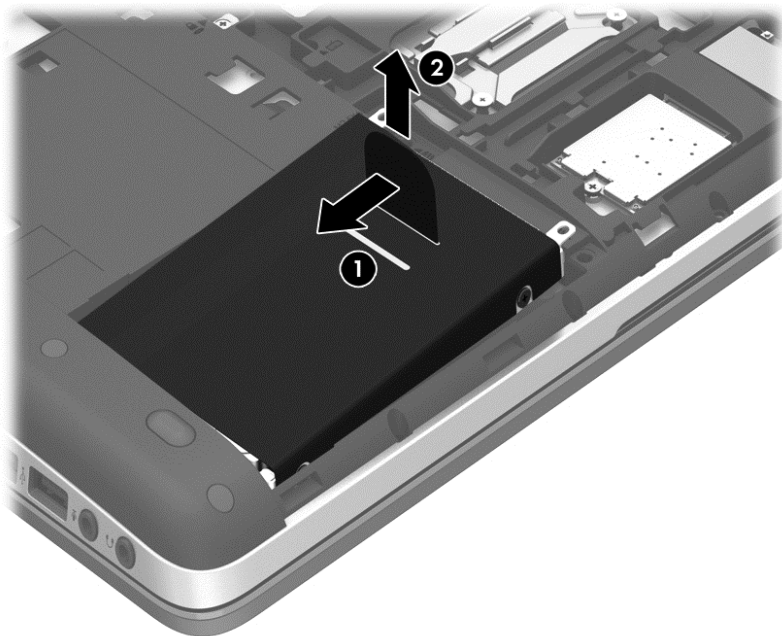

5. To remove the hard drive from the hard drive cover, remove the 4 Phillips PM3.0×4.0 screws **(1)** that secure the cover to the drive, and then lift the cover straight up and off the hard drive **(2)**.

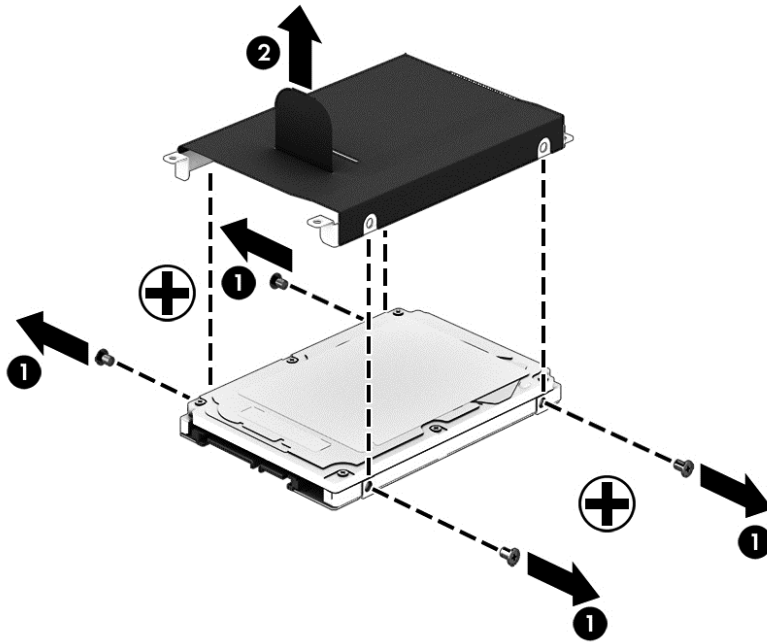

Reverse this procedure to install a hard drive.

Optical drive



NOTE: All optical drive spare part kits include an optical drive bezel, bracket, and screws.

Description	Spare part number
DVD-ROM drive	722829-001
Blu-ray ROM DVD±RW SuperMulti DL Drive (Intel models only)	722828-001
DVD±RW SuperMulti DL Drive	722830-001

Before removing the optical drive, follow these steps:

1. Shut down the computer. If you are unsure whether the computer is off or in Hibernation, turn the computer on, and then shut it down through the operating system.
2. Disconnect all external devices connected to the computer.
3. Disconnect the power from the computer by first unplugging the power cord from the AC outlet, and then unplugging the AC adapter from the computer.
4. Remove the battery (see [Battery on page 38](#)).
5. Remove the service door (see [Service door on page 39](#)).

Remove the optical drive:

1. Position the computer upside-down.
2. Remove the Phillips PM2.5×6.0 screw **(1)** that secures the optical drive to the computer.
3. Push the optical drive tab **(2)** to release the optical drive from the computer.

4. Remove the optical drive **(3)** from the computer.

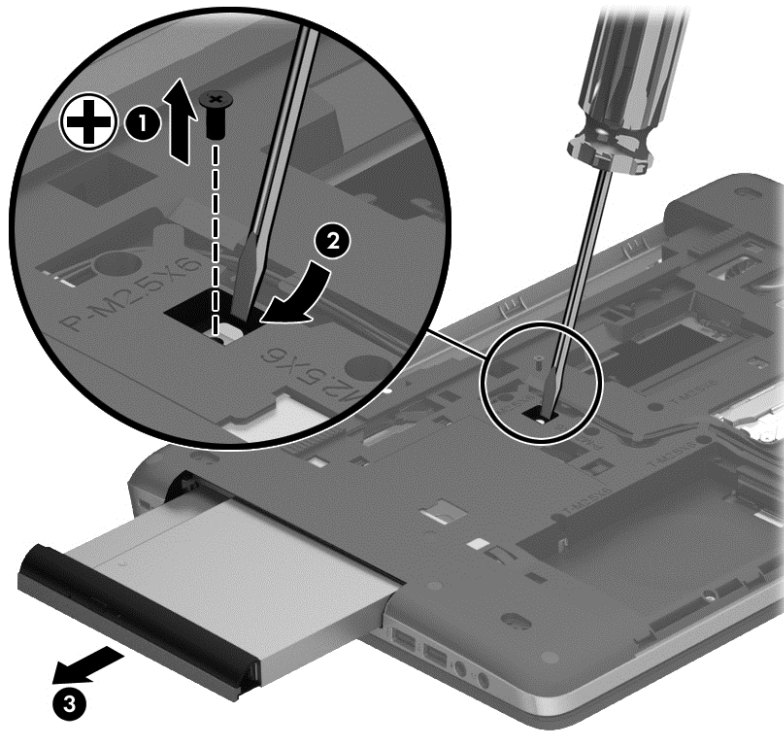

5. To remove the bracket from the optical drive, remove the Phillips PM2.0×3.0 screw **(1)** that secures the bracket to the drive, and then remove the bracket from the drive **(2)**.

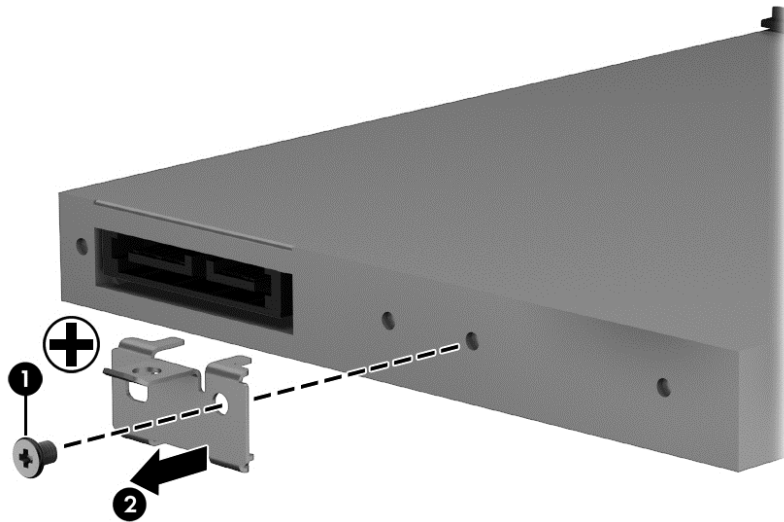

Reverse this procedure to install an optical drive.

Memory modules

 **NOTE:** Primary and expansion memory is installed in a stacked configuration in the bottom of the computer.

If only one memory module is installed, it must be installed in the bottom socket.

Description	Spare part number
2-GB (PC3L-12800, 1600-MHz, DDR3L)	691739-001
4-GB (PC3L-12800, 1600-MHz, DDR3L)	691740-001
8-GB (PC3L-12800, 1600-MHz, DDR3L)	693374-001

Update BIOS before adding memory modules

Before adding new memory, make sure you update the computer to the latest BIOS.

 **CAUTION:** Failure to update the computer to the latest BIOS prior to installing new memory may result in various system problems.

To update BIOS:

1. Navigate to www.hp.com.
2. Click **Support & Drivers** > click **Drivers & Software**.
3. In the **Enter a product name/number** box, type the computer model information, and then click **Search**.
4. Click the link for the computer model.
5. Select the operating system, and then click **Next**.
6. Under **Step 2: Select a Download**, click the **BIOS** link.
7. Click the link for the most recent BIOS.
8. Click the **Download** button, and then follow the on-screen instructions.

Before removing the memory module, follow these steps:

1. Shut down the computer. If you are unsure whether the computer is off or in Hibernation, turn the computer on, and then shut it down through the operating system.
2. Disconnect all external devices connected to the computer.
3. Disconnect the power from the computer by first unplugging the power cord from the AC outlet, and then unplugging the AC adapter from the computer.
4. Remove the battery (see [Battery on page 38](#)).
5. Remove the service door (see [Service door on page 39](#)).

Remove the memory module:

1. Position the computer upside-down.
2. Spread the retaining tabs **(1)** on each side of the memory module slot to release the memory module. (The edge of the module opposite the slot rises away from the computer.)

3. Remove the memory module **(2)** by pulling the module away from the slot at an angle.

 **NOTE:** Memory modules are designed with a notch to prevent incorrect insertion into the memory module slot.

 **NOTE:** The computer uses two memory sockets. The top socket houses the expansion memory module and the bottom socket houses the primary memory module. The removal procedure is the same for both memory sockets.

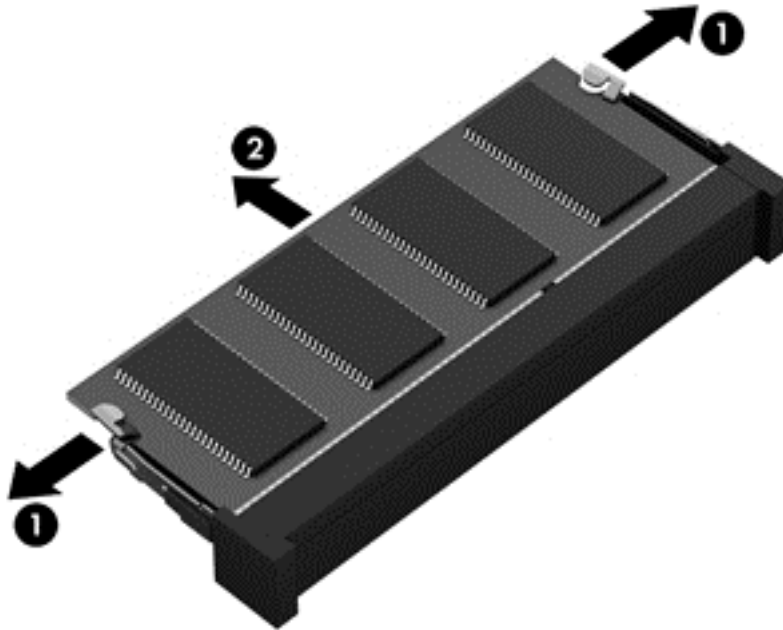

Reverse this procedure to install a memory module.

WLAN/Bluetooth combo card

The computer uses a card that provides both WLAN and Bluetooth functionality.

The WLAN module and WWAN module are not interchangeable.

Description	Spare part number
Intel Centrino Advanced-N 6235	670292-001
Atheros AR9485 802.11b/g/n 1x1 WiFi Adapter	675794-001
Atheros AR9565 802.11bgn 1x1 WiFi + BT4.0 combo Adapter	690019-001
Ralink RT3290LE 802.11bgn 1x1 Wi-Fi and Bluetooth 4.0 Combo Adapter	690020-001
Realtek RTL8188EE 802.11bgn Wi-Fi Adapter	709848-001
Broadcom BCM943228HMB 802.11abgn 2x2 Wi-Fi + BT 4.0 Combo Adapter (Intel models only)	731550-001

Before removing the WLAN module, follow these steps:

1. Shut down the computer. If you are unsure whether the computer is off or in Hibernation, turn the computer on, and then shut it down through the operating system.
2. Disconnect all external devices connected to the computer.
3. Disconnect the power from the computer by first unplugging the power cord from the AC outlet, and then unplugging the AC adapter from the computer.
4. Remove the battery (see [Battery on page 38](#)).
5. Remove the service door (see [Service door on page 39](#)).

Remove the WLAN module:

1. Position the computer upside-down.
2. Disconnect the WLAN antenna cables **(1)** from the terminals on the WLAN module.





NOTE: The WLAN antenna cable labeled “1” connects to the WLAN module “Main” terminal labeled “1”. The WLAN antenna cable labeled “2” connects to the WLAN module “Aux” terminal labeled “2”. If the computer is equipped with an 802.11a/b/g/n WLAN module, the yellow WLAN antenna cable connects to the middle terminal on the WLAN module.

3. Remove the two Phillips PM2.5×3.0 screws **(2)** that secure the WLAN module to the computer. (The edge of the module opposite the slot rises away from the computer.)

4. Remove the WLAN module (3) by pulling the module away from the slot at an angle.

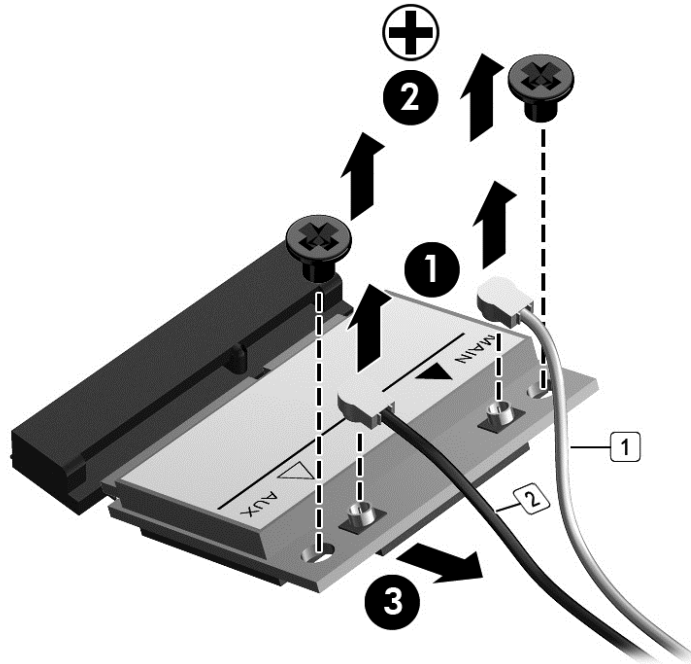
 **NOTE:** WLAN modules are designed with a notch to prevent incorrect insertion.



 **NOTE:** If the WLAN antennas are not connected to the terminals on the WLAN module, the protective sleeves must be installed on the antenna connectors, as shown in the following illustration.

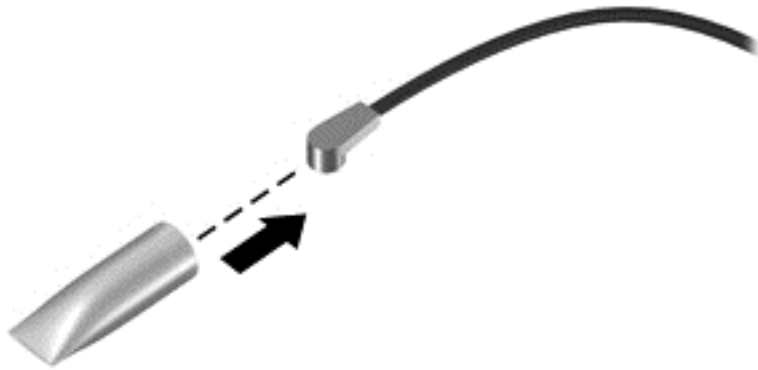

Reverse this procedure to install the WLAN module.

WWAN module

The WLAN module and WWAN module are not interchangeable.

The WWAN module is available on select models only.

Description	Spare part number
HP lt4112 LTE/HSPA+ Gobi 4G Module	704031-001
HP hs3110 HSPA+ Mobile Broadband Module	723895-001

Before removing the WWAN module, follow these steps:

1. Shut down the computer. If you are unsure whether the computer is off or in Hibernation, turn the computer on, and then shut it down through the operating system.
2. Disconnect all external devices connected to the computer.
3. Disconnect the power from the computer by first unplugging the power cord from the AC outlet, and then unplugging the AC adapter from the computer.
4. Remove the battery (see [Battery on page 38](#)).
5. Remove the service door (see [Service door on page 39](#)).

Remove the WWAN module:

1. Position the computer upside-down.
2. Disconnect the WWAN antenna cables **(1)** from the terminals on the WWAN module.





NOTE: The red WWAN antenna cable is connected to the WWAN module “Main” terminal. The blue WWAN antenna cable is connected to the WWAN module “Aux” terminal.

3. Remove the two Phillips PM2.5×3.0 screws **(2)** that secure the WWAN module to the computer. (The edge of the module opposite the slot rises away from the computer.)

4. Remove the WWAN module (3) by pulling the module away from the slot at an angle.

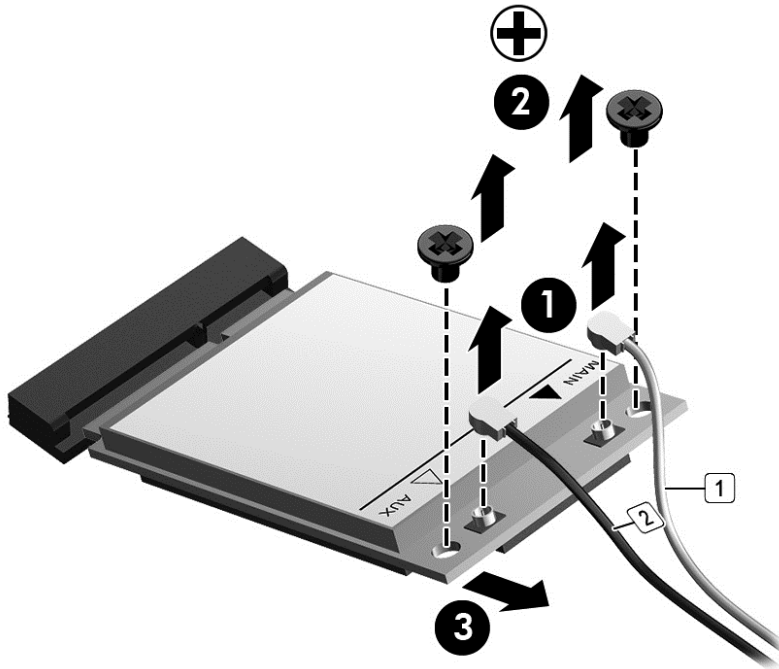
 **NOTE:** WWAN modules are designed with a notch to prevent incorrect insertion.



 **NOTE:** If the WWAN antennas are not connected to the terminals on the WWAN module, the protective sleeves must be installed on the antenna connectors, as shown in the following illustration.



Reverse this procedure to install the WWAN module.

Keyboard



NOTE: For a detailed list of available keyboards, see [Sequential part number listing on page 27](#).

Description	Spare part number
Keyboard	721953-xxx

Before removing the keyboard, follow these steps:

1. Shut down the computer. If you are unsure whether the computer is off or in Hibernation, turn the computer on, and then shut it down through the operating system.
2. Disconnect all external devices connected to the computer.
3. Disconnect the power from the computer by first unplugging the power cord from the AC outlet, and then unplugging the AC adapter from the computer.
4. Remove the battery (see [Battery on page 38](#)).
5. Remove the service door (see [Service door on page 39](#)).

Remove the keyboard:

1. Position the computer upside-down with the front toward you.
2. Remove the 2 Phillips PM2.5×6.0 screws that secure the keyboard to the computer.

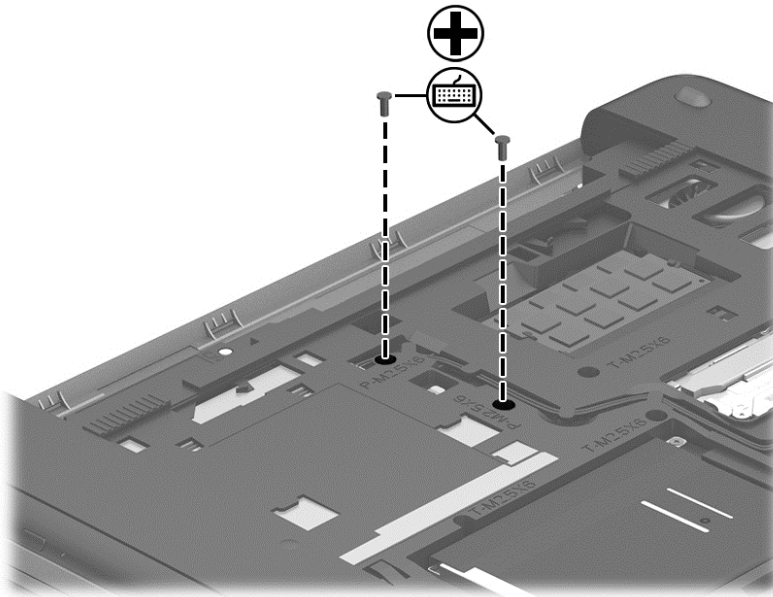

3. Position the computer upright with the front toward you.
4. Open the computer as far as possible.
5. Slide the keyboard slightly downward toward the palm rest to disengage the top of the keyboard from the top cover **(1)**.

6. Lift the top of the keyboard up at an angle **(2)**.

 **NOTE:** Make sure not to prematurely pull the keyboard cable out of the system board connector.



7. Rotate the keyboard until it rests on the palm rest **(1)**, and then disconnect the keyboard cable by lifting the keyboard connector latch **(2)**, and then disconnecting the keyboard cable from the system board **(3)**.

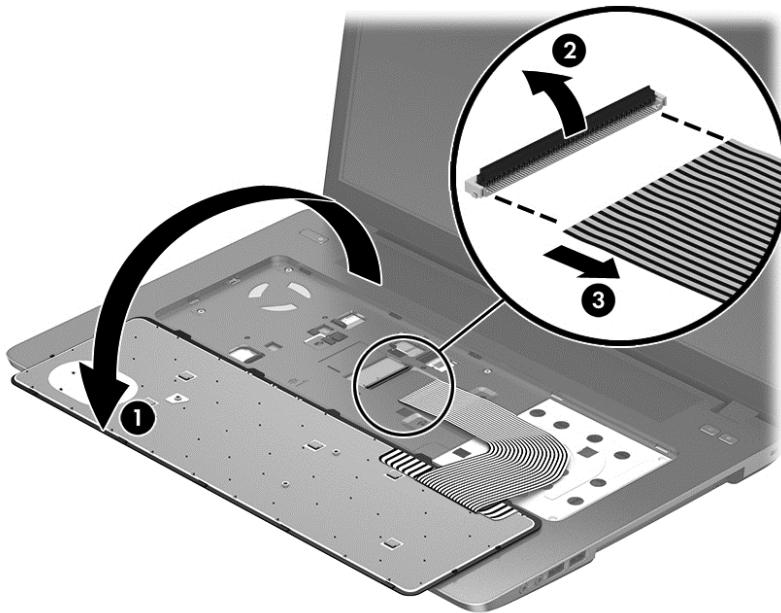

8. Remove the keyboard.

Reverse this procedure to install the keyboard.

6 Removal and replacement procedures for Authorized Service Provider parts

 **CAUTION:** Components described in this chapter should only be accessed by an authorized service provider. Accessing these parts can damage the computer or void the warranty.

Component replacement procedures

 **NOTE:** Details about your computer, including model, serial number, product key, and length of warranty, are on the service tag at the bottom of your computer. See [Service tag and PCID label on page 16](#) for details.

This chapter provides removal and replacement procedures for Authorized Service Provider only parts.

There are as many as 61 screws that must be removed, replaced, or loosened when servicing Authorized Service Provider only parts. Make special note of each screw size and location during removal and replacement.

RTC battery – models without WWAN

 **NOTE:** RTC battery location varies on model with and without WWAN modules.

WWAN models: you must remove the system board to replace the RTC battery.

Non-WWAN models: you must remove only the service cover to replace the RTC battery.

Description	Spare part number
RTC battery for use in models with AMD processors and models with Intel processors without WWAN	683601-001

Before removing the RTC battery, follow these steps:

1. Shut down the computer. If you are unsure whether the computer is off or in Hibernation, turn the computer on, and then shut it down through the operating system.
2. Disconnect all external devices connected to the computer.
3. Disconnect the power from the computer by first unplugging the power cord from the AC outlet, and then unplugging the AC adapter from the computer.
4. Remove the battery (see [Battery on page 38](#)).
5. Remove the service door (see [Service door on page 39](#)).

Remove the RTC battery:

1. Position the computer upside-down.
2. Use a thin screwdriver or similar tool to pry the battery out of the socket **(1)**.
3. Remove the battery from the socket **(2)**.

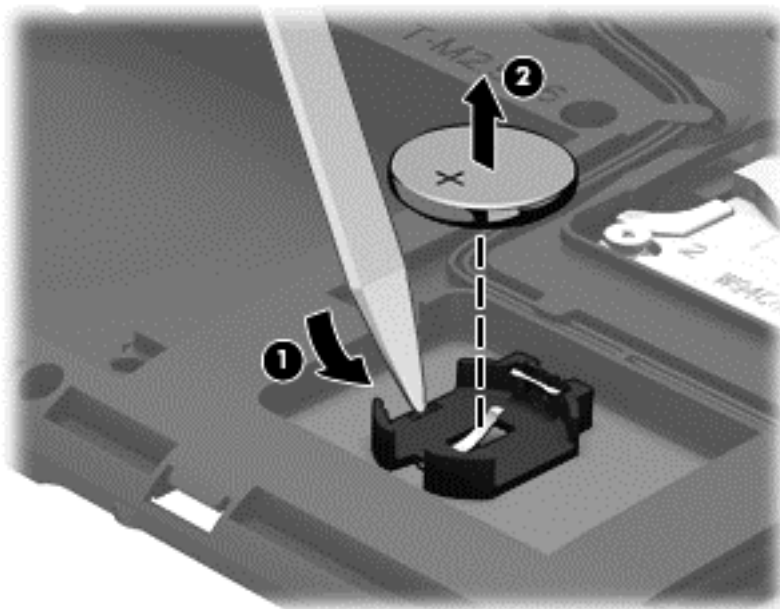

Reverse this procedure to install the RTC battery.

Top cover



NOTE: Top cover spare part kits include the touchpad assembly.

Description	Spare part number
Top cover with a fingerprint reader (includes fingerprint reader assembly)	721951-001
Top cover without a fingerprint reader (includes fingerprint reader plastic insert, bracket, and screws)	721952-001

Before removing the top cover, follow these steps:

1. Shut down the computer. If you are unsure whether the computer is off or in Hibernation, turn the computer on, and then shut it down through the operating system.
2. Disconnect all external devices connected to the computer.
3. Disconnect the power from the computer by first unplugging the power cord from the AC outlet, and then unplugging the AC adapter from the computer.
4. Remove the battery (see [Battery on page 38](#)).
5. Remove the following components:
 - a. Service door (see [Service door on page 39](#)).
 - b. Keyboard (see [Keyboard on page 51](#))
 - c. Optical drive ([Optical drive on page 43](#))

Remove the top cover:

1. Position the computer upside-down with the front toward you.

2. Remove the following covers and screws that secure the top cover to the computer:

 **NOTE:** Rubber screw covers come in three different sizes and are available in the Rubber Kit, spare part number 721948-001.

- (1) 2 rubber screw covers from the rear corners
- (2) 2 rubber screw covers from each side
- (3) 2 rubber screw covers from the front corners
- (4) 9 Torx T8M2.5×6.0 screws from the front corners

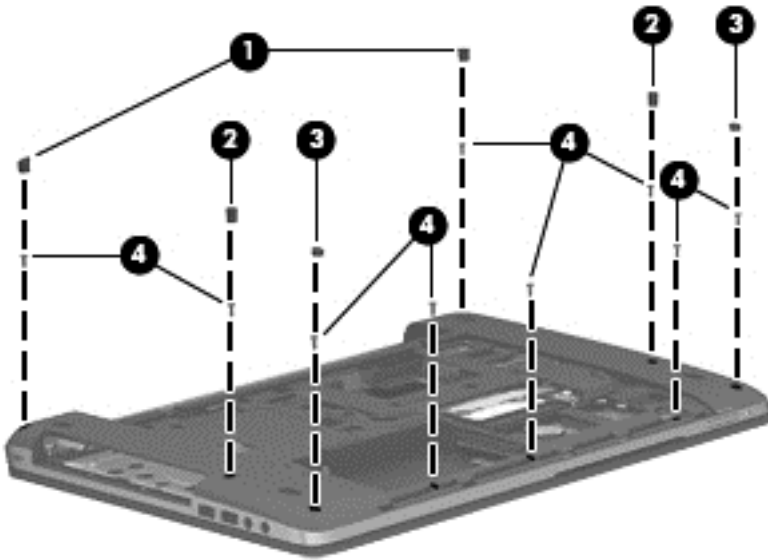

3. Remove the 5 remaining Torx T8M2.5×6.0 screws from the bottom of the computer.

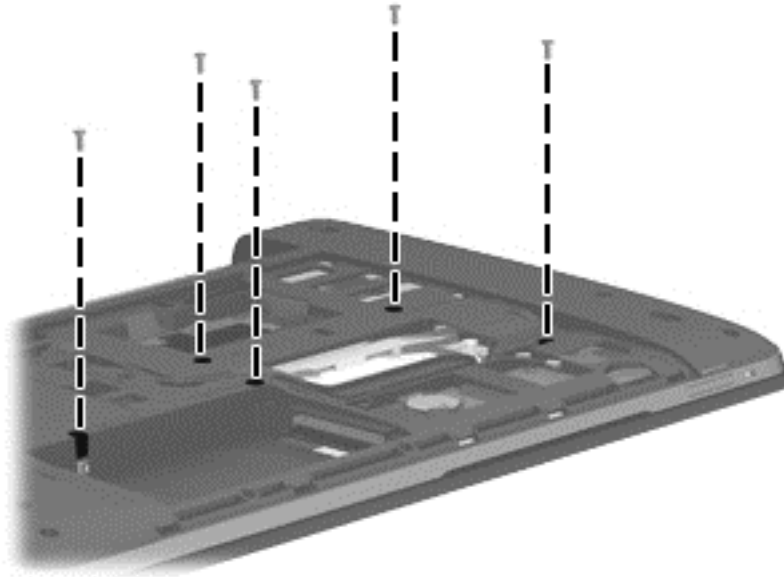

4. Remove the following screws:
 - (1) 2 Phillips PM2.0×3.0 screws from the optical drive bay
 - (2) 5 Phillips PM2.5×3.0 screws from the battery bay

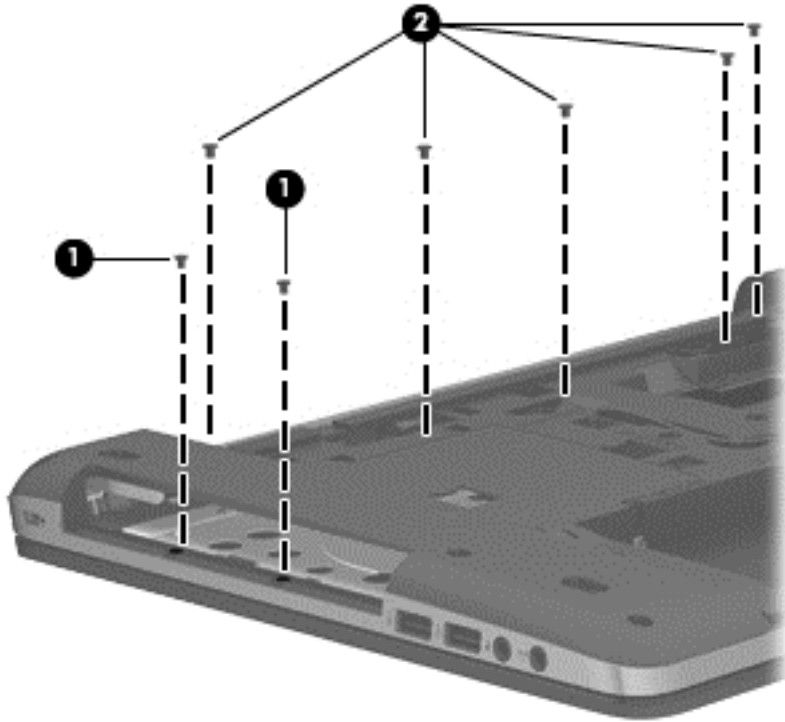

5. Position the computer upright and open it as far as possible.
6. Remove the 4 Torx T8M2.5×6.0 screws from the top of the computer.

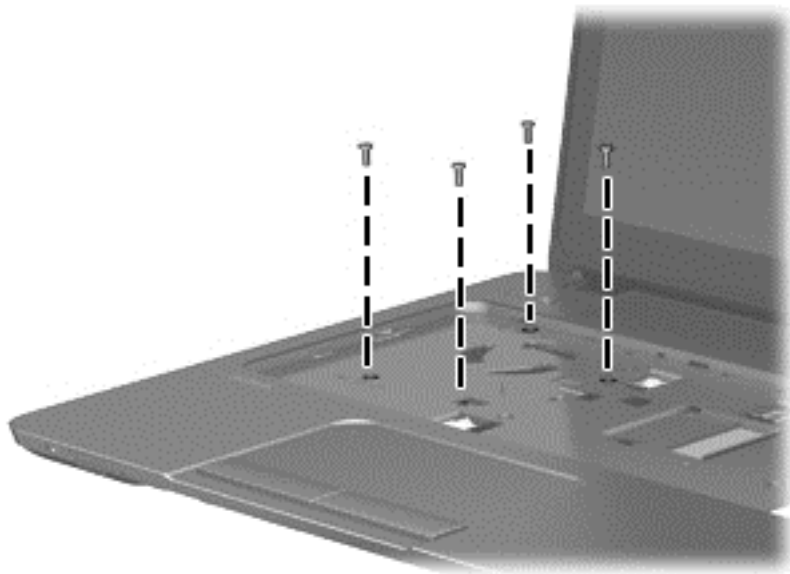

7. Disconnect the following cables from the system board:

- **(1):** Power button board cable
- **(2):** Speaker cable
- **(3):** Function board cable
- **(4):** Card reader cable

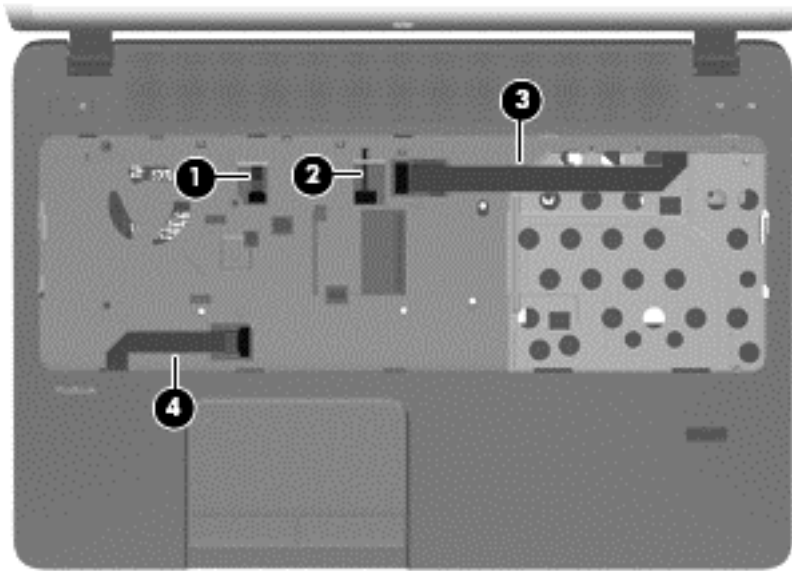

8. Pry the top cover off the computer to disengage it.

 **NOTE:** Begin by attempting to pry the top cover loose near the optical drive.

9. Lift the top of the top cover **(1)**, and the lift the top cover up slightly **(2)** to gain access to the connected audio/USB cable and connector underneath.

 **CAUTION:** To avoid damage to the cable and connector, make sure not to disconnect the cable when you lift the top cover from the computer.

10. Disconnect the audio/USB board cable (3) from the system board, and then remove the top cover from the computer.

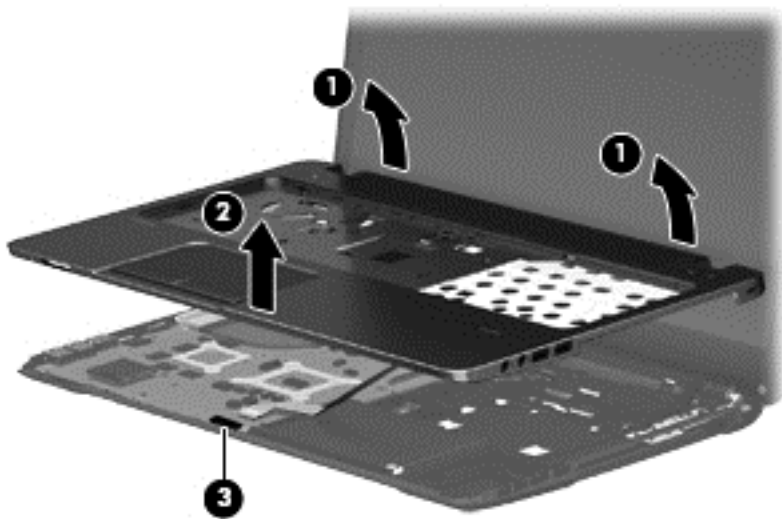

Reverse this procedure to install the top cover.

Use the following image to determine proper routing of top cover cables. All cables are included in the Cable Kit, spare part number 721936-001.

(1): Function board cable

(2): Power button board cable

(3): USB/audio board cable

(4): Card reader cable

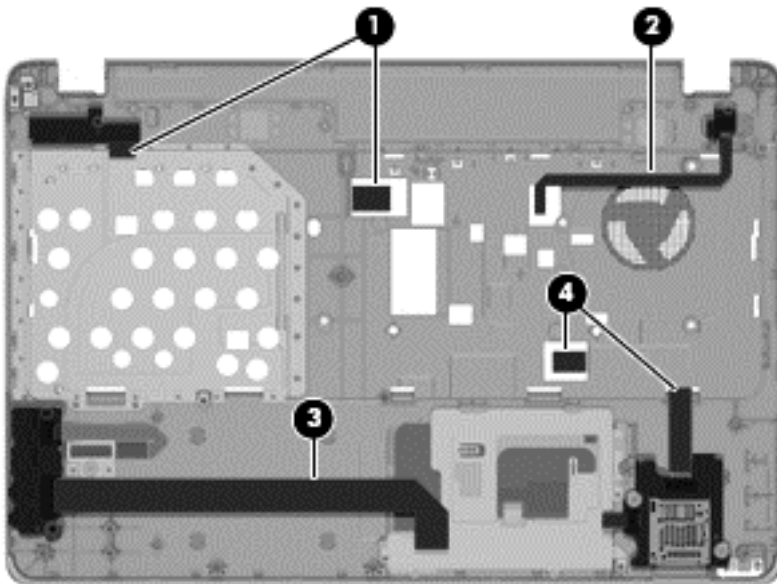

Reverse this procedure to install the top cover.

Speaker assembly

Description	Spare part number
Speaker assembly	721950-001



NOTE: You must remove the left speaker to remove to function board cable.

Before removing the speaker assembly, follow these steps:

1. Shut down the computer. If you are unsure whether the computer is off or in Hibernation, turn the computer on, and then shut it down through the operating system.
2. Disconnect all external devices connected to the computer.
3. Disconnect the power from the computer by first unplugging the power cord from the AC outlet, and then unplugging the AC adapter from the computer.
4. Remove the battery (see [Battery on page 38](#)).
5. Remove the following components:
 - a. Service door (see [Service door on page 39](#)).
 - b. Keyboard (see [Keyboard on page 51](#))
 - c. Optical drive ([Optical drive on page 43](#))
 - d. Top cover (see [Top cover on page 55](#))

Remove the speaker assembly:

1. Position the top cover upside-down.
2. Remove the 2 Phillips PM2.5×6.0 shoulder screws **(1)** that secure the speakers to the computer.
3. Lift the side of each speaker opposite of the screw, and then pull each speaker out from under the tab on the top cover **(2)**.
4. Remove the speaker cables from the clips built into the top cover **(3)**.

5. Remove the speakers from the computer (4).

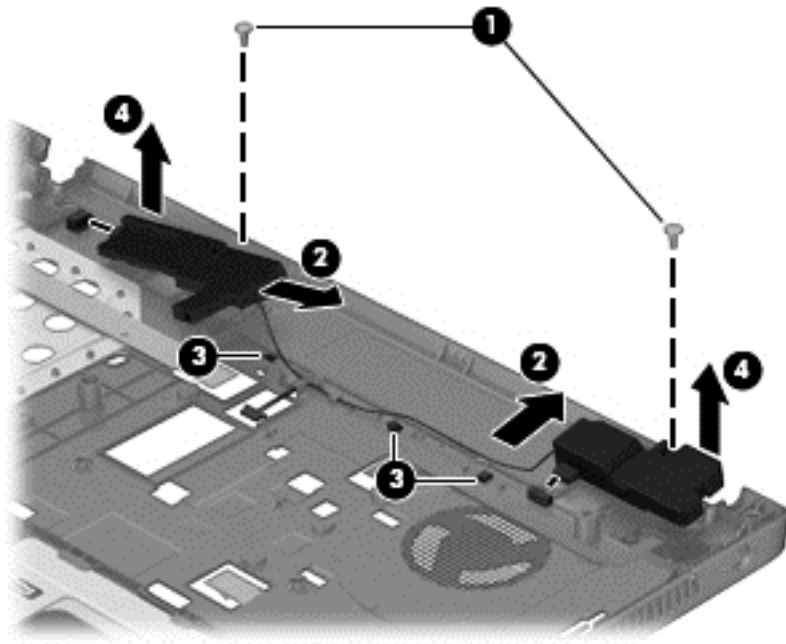

Reverse this procedure to install the speaker assembly.

Fingerprint reader assembly

Description	Spare part number
Fingerprint reader assembly (includes cable, bracket, holder, and screws)	721939-001

Before removing the fingerprint reader assembly, follow these steps:

1. Shut down the computer. If you are unsure whether the computer is off or in Hibernation, turn the computer on, and then shut it down through the operating system.
2. Disconnect all external devices connected to the computer.
3. Disconnect the power from the computer by first unplugging the power cord from the AC outlet, and then unplugging the AC adapter from the computer.
4. Remove the battery (see [Battery on page 38](#)).
5. Remove the following components:
 - a. Service door (see [Service door on page 39](#)).
 - b. Keyboard (see [Keyboard on page 51](#))
 - c. Optical drive ([Optical drive on page 43](#))
 - d. Top cover (see [Top cover on page 55](#))

Remove the fingerprint reader assembly:

1. Position the top cover upside-down.
2. Remove the Phillips PM2.0×2.0 broadhead screw (1) that secures the fingerprint reader board bracket to the top cover.
3. Slide the bracket toward the bottom of the top cover, and then lift it off the top cover (2).
4. Remove the fingerprint reader board and cable assembly from the top cover (3), and then lift the holder from the top cover (4).

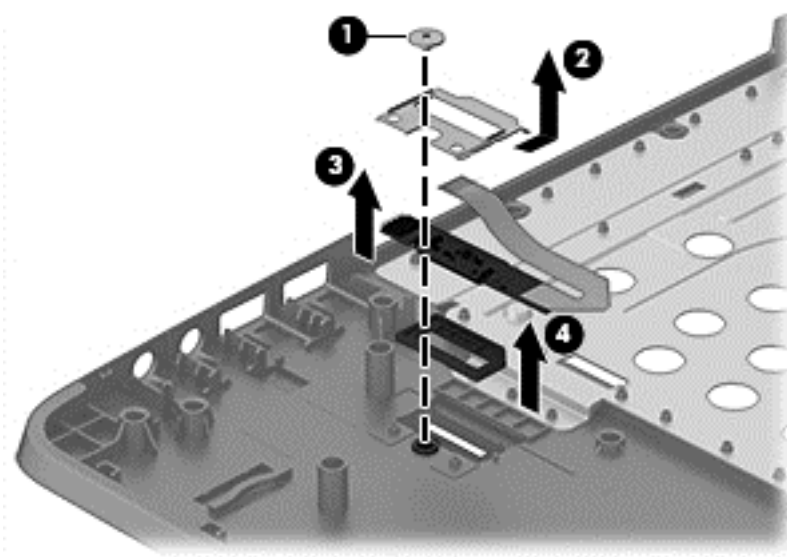

Reverse this procedure to install the fingerprint reader assembly.

Power button board

Description	Spare part number
Power button board assembly	721531-001

Before removing the power button board, follow these steps:

1. Shut down the computer. If you are unsure whether the computer is off or in Hibernation, turn the computer on, and then shut it down through the operating system.
2. Disconnect all external devices connected to the computer.
3. Disconnect the power from the computer by first unplugging the power cord from the AC outlet, and then unplugging the AC adapter from the computer.
4. Remove the battery (see [Battery on page 38](#)).
5. Remove the following components:
 - a. Service door (see [Service door on page 39](#))
 - b. Keyboard (see [Keyboard on page 51](#))
 - c. Optical drive ([Optical drive on page 43](#))
 - d. Top cover (see [Top cover on page 55](#))
 - e. Speakers (see [Speaker assembly on page 60](#)).

Remove the power button board:

1. Position the top cover upside-down.
2. Disconnect the cable from the board **(1)**.
3. Remove the Phillips PM2.0×3.0 screw **(2)** that secures the power button board to the top cover.

4. Lift the top side of the board up at an angle, and then lift board out from under the tab to remove it from the top cover **(3)**.

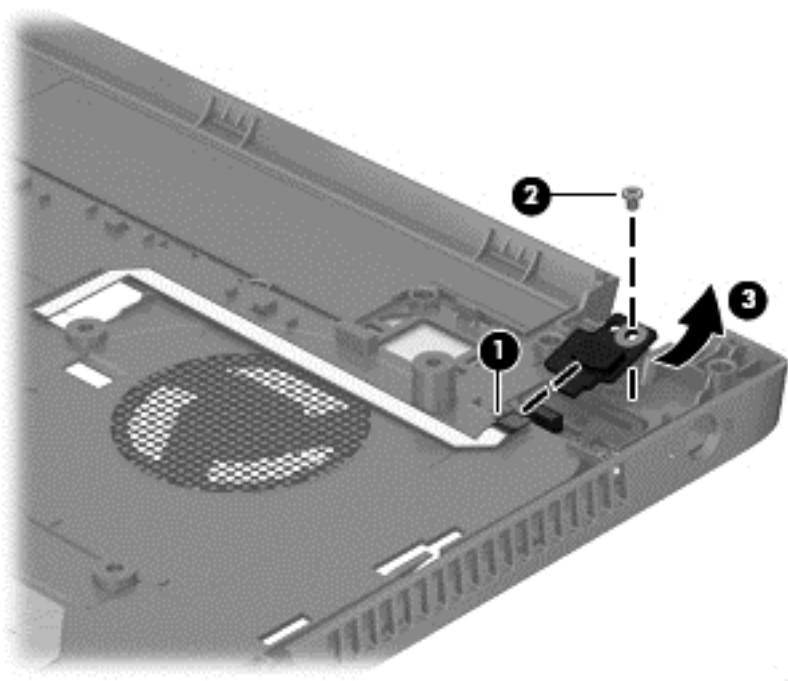

Reverse this procedure to install the power button board.

When installing the power button board, insert the bottom of the board into the slot, and then rotate board down into place. If the cable is connected to the board, it blocks the view of the tab on the board and the slot it inserts into.

Function board

Description	Spare part number
Function board	721943-001

Before removing the function board, follow these steps:

1. Shut down the computer. If you are unsure whether the computer is off or in Hibernation, turn the computer on, and then shut it down through the operating system.
2. Disconnect all external devices connected to the computer.
3. Disconnect the power from the computer by first unplugging the power cord from the AC outlet, and then unplugging the AC adapter from the computer.
4. Remove the battery (see [Battery on page 38](#)).
5. Remove the following components:
 - a. Service door (see [Service door on page 39](#))
 - b. Keyboard (see [Keyboard on page 51](#))
 - c. Optical drive ([Optical drive on page 43](#))
 - d. Top cover (see [Top cover on page 55](#))

Remove the function board:

1. Position the top cover upside-down.
2. Remove the Phillips PM2.0×3.0 screw **(1)** that secures the function board to the top cover.
3. Lift the cable side of the board slightly, and then pull the board toward the right (inside of cover) until the left side of the board comes out from under the holder **(2)**.

4. Turn the board upside down, and then disconnect the cable (3) from the board (4).

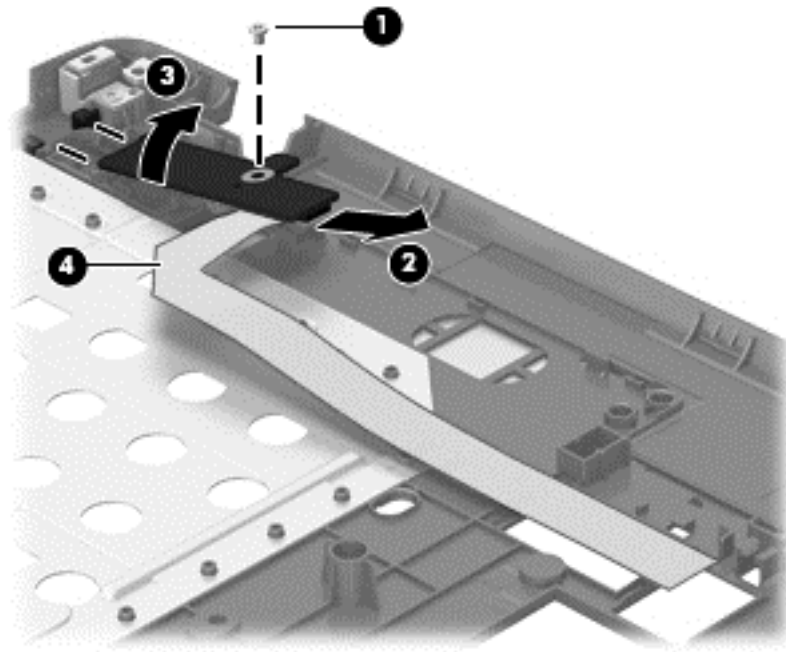

5. Remove the function board from the top cover.
Reverse this procedure to install the function board.

Card reader board

Description	Spare part number
Card reader board	721535-001

Before removing the card reader board, follow these steps:

1. Shut down the computer. If you are unsure whether the computer is off or in Hibernation, turn the computer on, and then shut it down through the operating system.
2. Disconnect all external devices connected to the computer.
3. Disconnect the power from the computer by first unplugging the power cord from the AC outlet, and then unplugging the AC adapter from the computer.
4. Remove the battery (see [Battery on page 38](#)).
5. Remove the following components:
 - a. Service door (see [Service door on page 39](#)).
 - b. Keyboard (see [Keyboard on page 51](#))
 - c. Optical drive ([Optical drive on page 43](#))
 - d. Top cover (see [Top cover on page 55](#))

Remove the card reader board:

 **NOTE:** Before you remove the card reader, make sure nothing (memory card or plastic insert) is installed.

1. Position the top cover upside-down.
2. Disconnect the cable that routes to the touchpad buttons **(1)**.
3. Disconnect the cable that routes to the system board **(2)**.
4. Remove the two Phillips PM2.0×2.0 broadhead screws **(3)** that secure the card reader board to the computer.
5. Remove the card reader board from the top cover **(4)**.

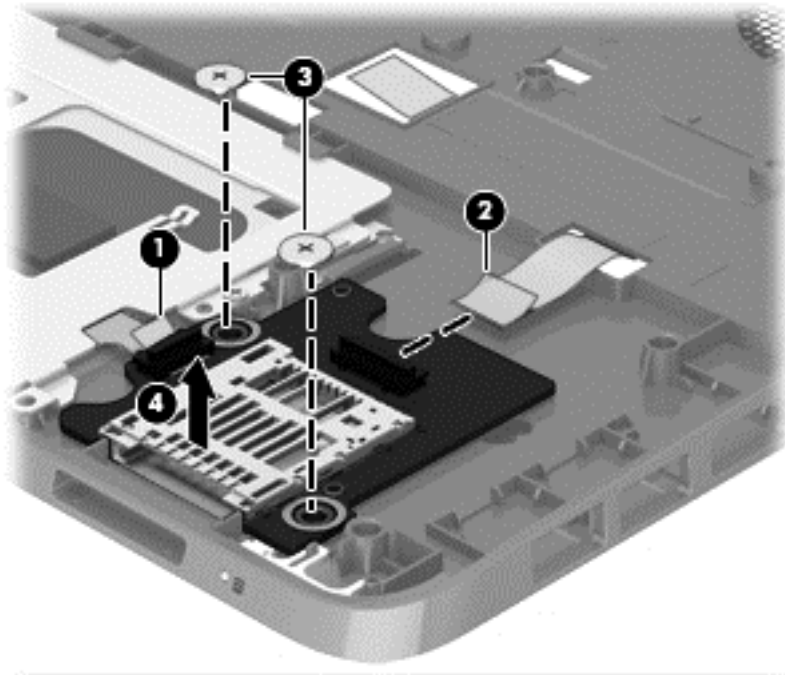

Reverse this procedure to install the card reader board.

USB/audio board

Description	Spare part number
USB/audio board	721542-001

Before removing the USB/audio board, follow these steps:

1. Shut down the computer. If you are unsure whether the computer is off or in Hibernation, turn the computer on, and then shut it down through the operating system.
2. Disconnect all external devices connected to the computer.
3. Disconnect the power from the computer by first unplugging the power cord from the AC outlet, and then unplugging the AC adapter from the computer.
4. Remove the battery (see [Battery on page 38](#)).
5. Remove the following components:
 - a. Service door (see [Service door on page 39](#)).
 - b. Keyboard (see [Keyboard on page 51](#))
 - c. Optical drive ([Optical drive on page 43](#))
 - d. Top cover (see [Top cover on page 55](#))

Remove the USB/audio board:

1. Position the top cover upside-down.
2. Disconnect the cable that routes to the system board **(1)**.
3. Disconnect the cable that routes to the fingerprint reader board **(2)**.
4. Remove the Phillips PM2.5×4.0 screw **(3)** that secures the USB/audio board to the computer.
5. Rotate the top of the board upward, pull the board away from the connectors (to remove them from top cover holes), and then lift the board off the top cover **(4)**.

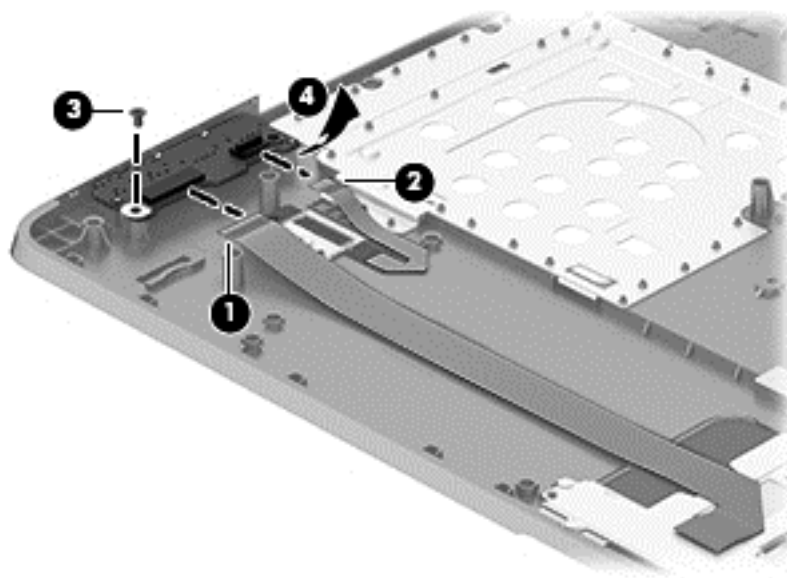

Reverse this procedure to install the USB/audio board.

System board



NOTE: All system board spare part kits include replacement thermal material.

Description	Spare part number
Intel models:	
Models without Windows 8 with 1-GB of discrete graphics memory	721521-001
Models without Windows 8 with 2-GB of discrete graphics memory	721522-001
Models without Windows 8, with UMA graphics, without WWAN	721523-001
Models without Windows 8, with UMA graphics, with WWAN	721525-001
Windows 8 Standard models with 1-GB of discrete graphics memory	721521-501
Windows 8 Professional models with 1-GB of discrete graphics memory	721521-601
Windows 8 Standard models with 2-GB of discrete graphics memory	721522-501
Windows 8 Professional models with 2-GB of discrete graphics memory	721522-601
Windows 8 Standard models, UMA graphics, without WWAN	721523-501
Windows 8 Professional models, UMA graphics, without WWAN	721523-601
Windows 8 Standard models, UMA graphics, with WWAN	721525-501
Windows 8 Professional models, UMA graphics, with WWAN	721525-601
AMD models:	
Models without Windows 8 with 1-GB of discrete graphics memory	722818-001
Models without Windows 8 with 2-GB of discrete graphics memory	722821-001
Models without Windows 8 with UMA graphics	722824-001
Windows 8 Standard models with 1-GB of discrete graphics memory	722818-501
Windows 8 Professional models with 1-GB of discrete graphics memory	722818-601
Windows 8 Standard models with 2-GB of discrete graphics memory	722821-501
Windows 8 Professional models with 2-GB of discrete graphics memory	722821-601
Windows 8 Standard models with UMA graphics	722824-501
Windows 8 Professional models with UMA graphics	722824-601

Before removing the system board, follow these steps:

1. Shut down the computer. If you are unsure whether the computer is off or in Hibernation, turn the computer on, and then shut it down through the operating system.
2. Disconnect all external devices connected to the computer.
3. Disconnect the power from the computer by first unplugging the power cord from the AC outlet, and then unplugging the AC adapter from the computer.

4. Remove the battery (see [Battery on page 38](#)).
5. Remove the following components:
 - a. Service door (see [Service door on page 39](#)).
 - b. Hard drive (see [Hard drive on page 40](#))
 - c. Optical drive (see [Optical drive on page 43](#))
 - d. Keyboard (see [Keyboard on page 51](#))
 - e. Top cover (see [Top cover on page 55](#))

When replacing the system board, be sure to remove the following components from the defective system board and install on the replacement system board:

- Memory module (see [Memory modules on page 45](#))
- WLAN/Bluetooth module (see [WLAN/Bluetooth combo card on page 47](#))
- WWAN module (see [WWAN module on page 49](#))
- Processor (see [Processor on page 80](#))

Remove the system board:

1. Position the computer upright with the front toward you.
2. Disconnect the display cable **(1)** from the system board.
3. Disconnect the battery connector cable from the system board **(2)**.
4. Remove the 3 Phillips PM2.5×4.0 screws **(3)** that secure the system board and the optical drive extension board to the computer.

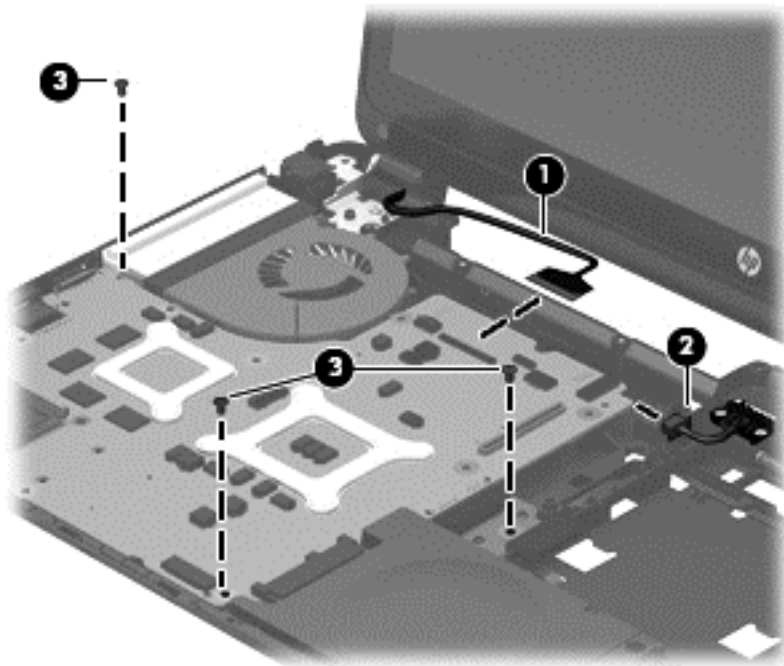

5. Lift the right side of the system board up at an angle **(1)**.

6. Pull the system board up and toward the right to remove it from the computer **(2)**.

 **NOTE:** The power cable connects to a connector on the bottom of the system board. When you remove the system board, the power cable will be removed from its routing path and remain connected to the system board.

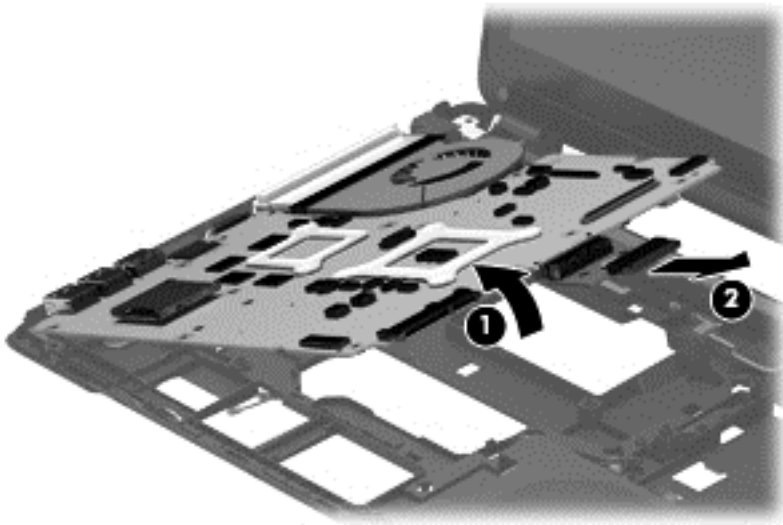

Reverse this procedure to install the system board.

Optical drive extension board

Description	Spare part number
Optical drive extension board	721944-001

Before removing the optical drive extension board, follow these steps:

1. Shut down the computer. If you are unsure whether the computer is off or in Hibernation, turn the computer on, and then shut it down through the operating system.
2. Disconnect all external devices connected to the computer.
3. Disconnect the power from the computer by first unplugging the power cord from the AC outlet, and then unplugging the AC adapter from the computer.
4. Remove the battery (see [Battery on page 38](#)).
5. Remove the following components:
 - a. Service door (see [Service door on page 39](#)).
 - b. Hard drive (see [Hard drive on page 40](#))
 - c. Optical drive (see [Optical drive on page 43](#))
 - d. WLAN/Bluetooth module (see [WLAN/Bluetooth combo card on page 47](#))
 - e. Keyboard (see [Keyboard on page 51](#))
 - f. Top cover (see [Top cover on page 55](#))
 - g. System board (see [System board on page 69](#))

Remove the optical drive extension board:

- ▲ Pull the optical drive extension board straight away from the side of the system board.

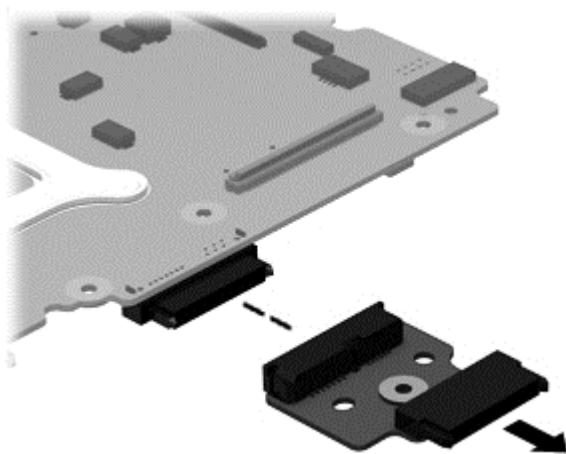

Reverse this procedure to install the optical drive extension board.

Power cable

The power cable is included in the Cable Kit, spare part number 721936-001.

Before removing the power cable, follow these steps:

1. Shut down the computer. If you are unsure whether the computer is off or in Hibernation, turn the computer on, and then shut it down through the operating system.
2. Disconnect all external devices connected to the computer.
3. Disconnect the power from the computer by first unplugging the power cord from the AC outlet, and then unplugging the AC adapter from the computer.
4. Remove the battery (see [Battery on page 38](#)).
5. Remove the following components:
 - a. Service door (see [Service door on page 39](#)).
 - b. Hard drive (see [Hard drive on page 40](#))
 - c. Optical drive (see [Optical drive on page 43](#))
 - d. WLAN/Bluetooth module (see [WLAN/Bluetooth combo card on page 47](#))
 - e. WWAN module (see [WWAN module on page 49](#))
 - f. Keyboard (see [Keyboard on page 51](#))
 - g. Top cover (see [Top cover on page 55](#))
 - h. System board (see [System board on page 69](#))

Remove the power cable:

1. Position the system board upside-down.
2. Disconnect the cable from the bottom of the system board.

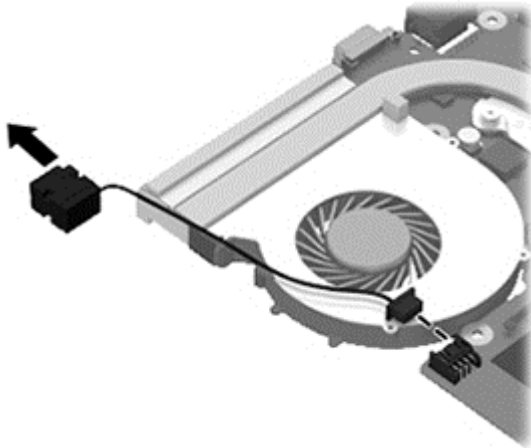

Reverse this procedure to install the power cable.

Battery cable

The battery cable is included in the Cable Kit, spare part number 721936-001.

Before removing the battery cable, follow these steps:

1. Shut down the computer. If you are unsure whether the computer is off or in Hibernation, turn the computer on, and then shut it down through the operating system.
2. Disconnect all external devices connected to the computer.
3. Disconnect the power from the computer by first unplugging the power cord from the AC outlet, and then unplugging the AC adapter from the computer.
4. Remove the battery (see [Battery on page 38](#)).
5. Remove the following components:
 - a. Service door (see [Service door on page 39](#)).
 - b. Hard drive (see [Hard drive on page 40](#))
 - c. Optical drive (see [Optical drive on page 43](#))
 - d. WLAN/Bluetooth module (see [WLAN/Bluetooth combo card on page 47](#))
 - e. WWAN module (see [WWAN module on page 49](#))
 - f. Keyboard (see [Keyboard on page 51](#))
 - g. Top cover (see [Top cover on page 55](#))
 - h. System board (see [System board on page 69](#))

Remove the battery cable:

1. Position the computer upright and open as far as possible.
2. Remove the 2 Phillips PM2.5×4.0 screws that secure the battery cable to the computer **(1)**.
3. Remove the battery cable from the computer **(2)**.

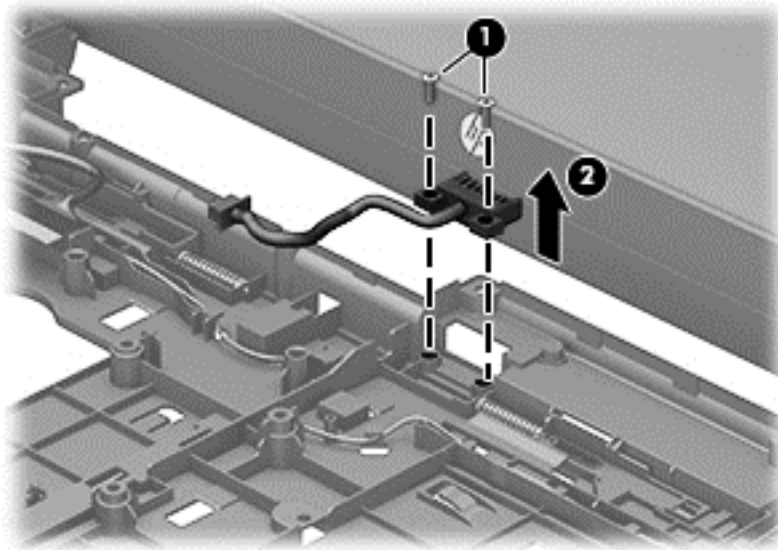

Reverse this procedure to install the battery cable.

RTC battery – WWAN models

 **NOTE:** RTC battery location varies on model with and without WWAN modules.

WWAN models: you must remove the system board to replace the RTC battery.

Non-WWAN models: you must remove only the service cover to replace the RTC battery.

Description	Spare part number
RTC battery for use in models with Intel processors with WWAN	721532-001

Before removing the RTC battery, follow these steps:

1. Shut down the computer. If you are unsure whether the computer is off or in Hibernation, turn the computer on, and then shut it down through the operating system.
2. Disconnect all external devices connected to the computer.
3. Disconnect the power from the computer by first unplugging the power cord from the AC outlet, and then unplugging the AC adapter from the computer.
4. Remove the battery (see [Battery on page 38](#)).
5. Remove the following components:
 - a. Service door (see [Service door on page 39](#)).
 - b. Hard drive (see [Hard drive on page 40](#))
 - c. Optical drive (see [Optical drive on page 43](#))
 - d. WLAN/Bluetooth module (see [WLAN/Bluetooth combo card on page 47](#))
 - e. WWAN module (see [WWAN module on page 49](#))
 - f. Keyboard (see [Keyboard on page 51](#))
 - g. Top cover (see [Top cover on page 55](#))
 - h. System board (see [System board on page 69](#))

Remove the RTC battery:

1. Position the system board upside-down.
2. Disconnect the cable from the system board connector **(1)**.

3. Lift the battery to disengage it from the tape that secures it to the system board **(2)**.

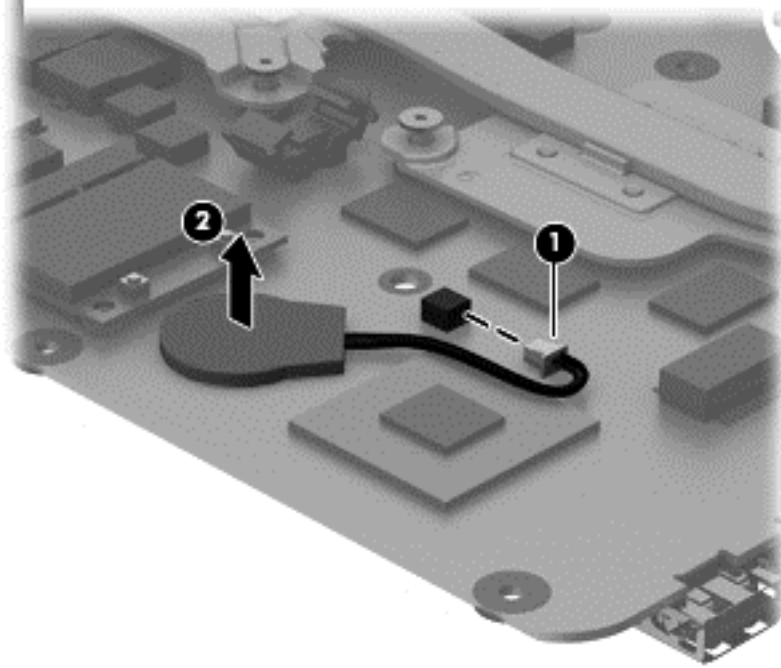

Reverse this procedure to install the RTC battery.

Fan/heat sink assembly

All fan/heat sink assembly spare part kits include replacement thermal material.

Description	Spare part number
Fan/heat sink assembly for use in models with UMA graphics	721938-001
Fan/heat sink assembly for use in models with discrete graphics	721937-001

Before removing the fan/heat sink assembly, follow these steps:

1. Shut down the computer. If you are unsure whether the computer is off or in Hibernation, turn the computer on, and then shut it down through the operating system.
2. Disconnect all external devices connected to the computer.
3. Disconnect the power from the computer by first unplugging the power cord from the AC outlet, and then unplugging the AC adapter from the computer.
4. Remove the battery (see [Battery on page 38](#)).
5. Remove the following components:
 - a. Service door (see [Service door on page 39](#)).
 - b. Hard drive (see [Hard drive on page 40](#))
 - c. Optical drive (see [Optical drive on page 43](#))
 - d. WLAN/Bluetooth module (see [WLAN/Bluetooth combo card on page 47](#))
 - e. WWAN module (see [WWAN module on page 49](#))
 - f. Keyboard (see [Keyboard on page 51](#))
 - g. Top cover (see [Top cover on page 55](#))
 - h. System board (see [System board on page 69](#))

Remove the fan/heat sink assembly:

1. Position the system board upside-down.
2. Models are available with either UMA or discrete graphics. The heat sink on discrete models includes 2 additional screws. Refer to the following steps that match your model:

Discrete models:

- a. To remove the discrete fan/heat sink assembly, in the order indicated on the heat sink, loosen the 6 captive Phillips screws **(1)-(6)** that secure the heat sink to the system board.
- b. Disconnect the fan cable from the system board **(7)**.

- c. Lift the fan/heat sink from the system board (8).

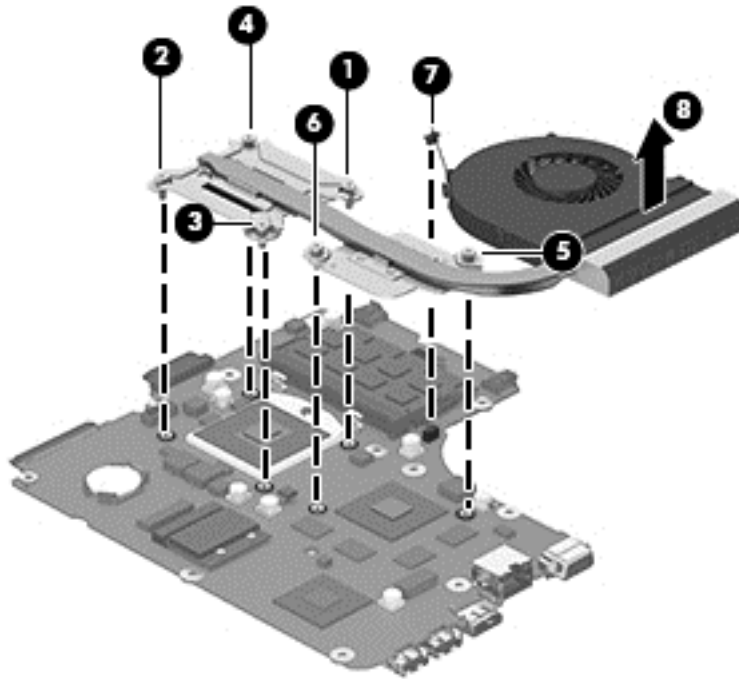

 **NOTE:** For discrete models, thoroughly clean thermal material from the surfaces of the system board components (1)(3) and the heat sink (2)(4) each time you remove the heat sink. All heat sink and processor spare part kits include thermal material.

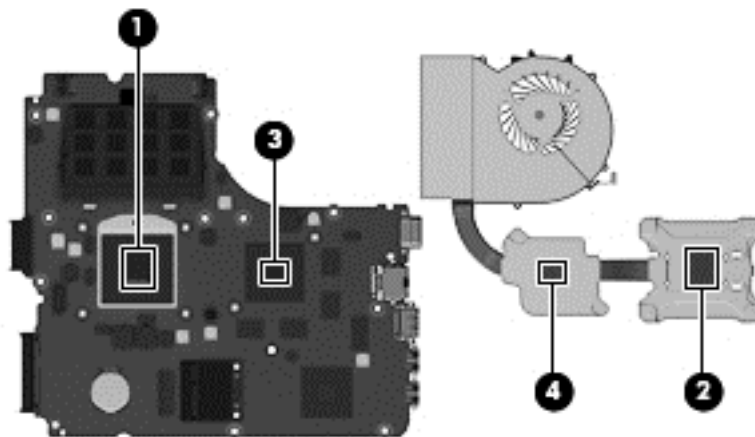

UMA models:

- a. To remove the UMA fan/heat sink assembly, in the order indicated on the heat sink, loosen the 4 captive Phillips screws (1)-(4) that secure the heat sink to the system board.
- b. Disconnect the fan cable from the system board (5).

- c. Lift the fan/heat sink from the system board (6).

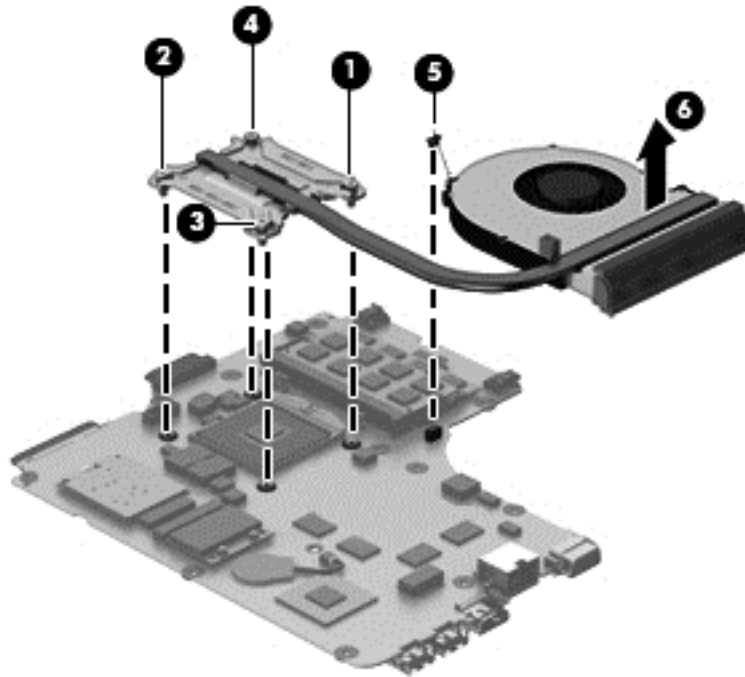

 **NOTE:** For UMA models, thoroughly clean thermal material from the surfaces of the system board component (1) and the heat sink (2) each time you remove the heat sink. All heat sink and processor spare part kits include thermal material.

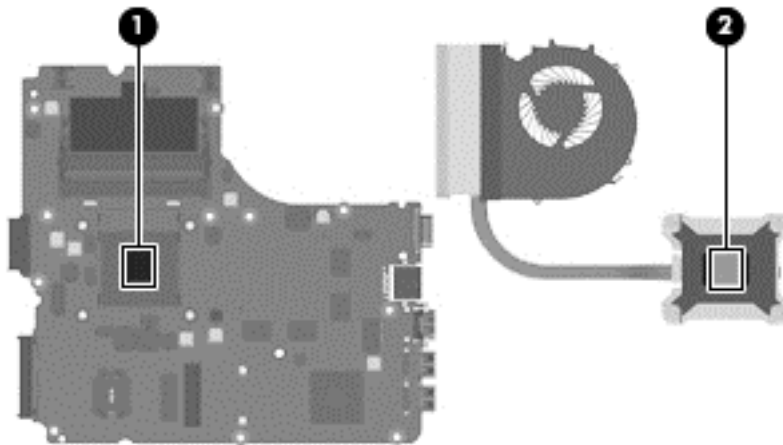

Reverse this procedure to install the fan/heat sink assembly.

Processor



NOTE: All processor spare part kits include replacement thermal material.

Description	Spare part number
Intel models:	
Intel Core i7 3632QM, 2.2-GHz processor with 6-MB L3 cache	701658-001
Intel Core i5 3380M, 2.9-GHz processor with 3-MB L3 cache	708762-001
Intel Core i5 3340M, 2.7-GHz processor with 3-MB L3 cache	708761-001
Intel Core i5 3230M, 2.6-GHz processor with 3-MB L3 cache	711903-001
Intel Core i3 3130M, 2.6-GHz processor with 3-MB L3 cache	713163-001
Intel Core i3 3120M, 2.5-GHz processor with 3-MB L3 cache	700627-001
Intel Pentium 2020M, 2.4-GHz, with 2-MB L3 cache	700628-001
Intel Celeron 1000M, 1.8-GHz, with 2-MB L3 cache	713162-001
AMD models:	
AMD A8-5550M, 3.1-GHz/2.1-GHz, 4-MB L2 cache, HD 8550G graphics	713551-001
AMD A8-4500M, 2.8-GHz/1.9-GHz, 4-MB L2 cache, HD 7640G graphics	683048-001
AMD A6-5350M, 3.5-GHz/2.9-GHz, 1-MB L2 cache, HD 8450G graphics	713550-001
AMD A6-4400M, 3.2-GHz/2.7-GHz, 1-MB L2 cache, HD 7520G graphics	683047-001
AMD A4-5150M, 3.3-GHz/2.7-GHz, 1-MB L2 cache, HD 8350G graphics	713549-001
AMD A4-4300M, 3.0-GHz/2.5-GHz, 1-MB L2 cache, HD 7420G graphics	685990-001

Before removing the processor, follow these steps:

1. Shut down the computer. If you are unsure whether the computer is off or in Hibernation, turn the computer on, and then shut it down through the operating system.
2. Disconnect all external devices connected to the computer.
3. Disconnect the power from the computer by first unplugging the power cord from the AC outlet, and then unplugging the AC adapter from the computer.
4. Remove the battery (see [Battery on page 38](#)).
5. Remove the following components:
 - a. Service door (see [Service door on page 39](#)).
 - b. Hard drive (see [Hard drive on page 40](#))
 - c. Optical drive (see [Optical drive on page 43](#))
 - d. WLAN/Bluetooth module (see [WLAN/Bluetooth combo card on page 47](#))
 - e. WWAN module (see [WWAN module on page 49](#))
 - f. Keyboard (see [Keyboard on page 51](#))
 - g. Top cover (see [Top cover on page 55](#))

- h. System board (see [System board on page 69](#))
- i. Fan/heat sink assembly (see [Fan/heat sink assembly on page 77](#))

Remove the processor:

1. Position the system board upside-down.
2. Use a flat-bladed screwdriver to turn the processor locking screw **(1)** one-half turn counterclockwise until you hear a click.
3. Lift the processor **(2)** straight up and remove it.

 **NOTE:** The gold triangle **(3)** on the processor must be aligned with the triangle embossed on the processor slot **(4)** when you install the processor.

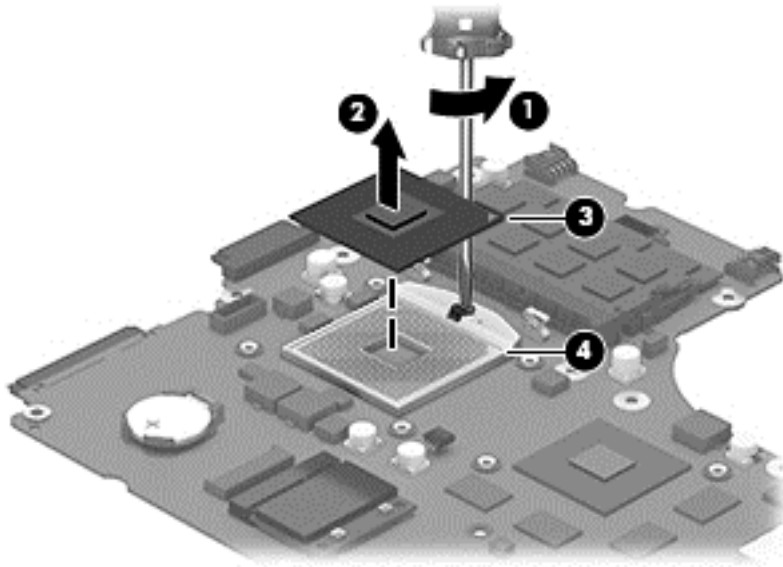

Reverse this procedure to install the processor.

Display assembly

All display assemblies include WLAN antenna transceivers and cables.

For a list of individual display spare parts, see [Display components on page 22](#).

Description	Spare part number
Intel models:	
Display assembly for use in models without a webcam and without WWAN	721941-001
Display assembly for use in models with a webcam and with WWAN	721942-001
Display assembly for use in models with a webcam and without WWAN	724940-001
Display assembly, 39.6-cm (15.6-inch), HD, anti-glare for use in touchscreen models	724941-001
AMD models:	
Display assembly for use in models with a webcam	724942-001
Display assembly for use in models without a webcam	722816-001

Before removing the display assembly, follow these steps:

1. Shut down the computer. If you are unsure whether the computer is off or in Hibernation, turn the computer on, and then shut it down through the operating system.
2. Disconnect all external devices connected to the computer.
3. Disconnect the power from the computer by first unplugging the power cord from the AC outlet, and then unplugging the AC adapter from the computer.
4. Remove the battery (see [Battery on page 38](#)).
5. Remove the following components:
 - a. Service door (see [Service door on page 39](#)).
 - b. WLAN/Bluetooth module (see [WLAN/Bluetooth combo card on page 47](#))
 - c. WWAN module (see [WWAN module on page 49](#))
 - d. Keyboard (see [Keyboard on page 51](#))
 - e. Top cover (see [Top cover on page 55](#))

Remove the display assembly:

1. Position the computer upside down.
2. Remove the WLAN antennas from the routing path on the bottom of the computer **(1)**.

3. Pull the antennas through the hole that leads to the other side of the top cover **(2)**.

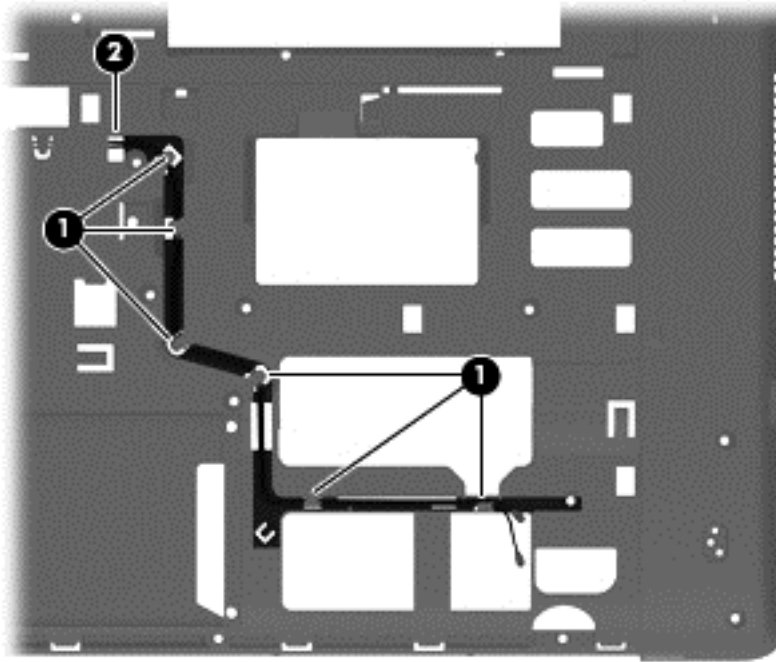

4. Place the computer upright and open as far as possible.
5. Remove the WLAN antennas from the tabs and the routing path **(1)** on the top of the computer.
6. For reassembly, note the location that the antennas route through the chassis **(2)**.

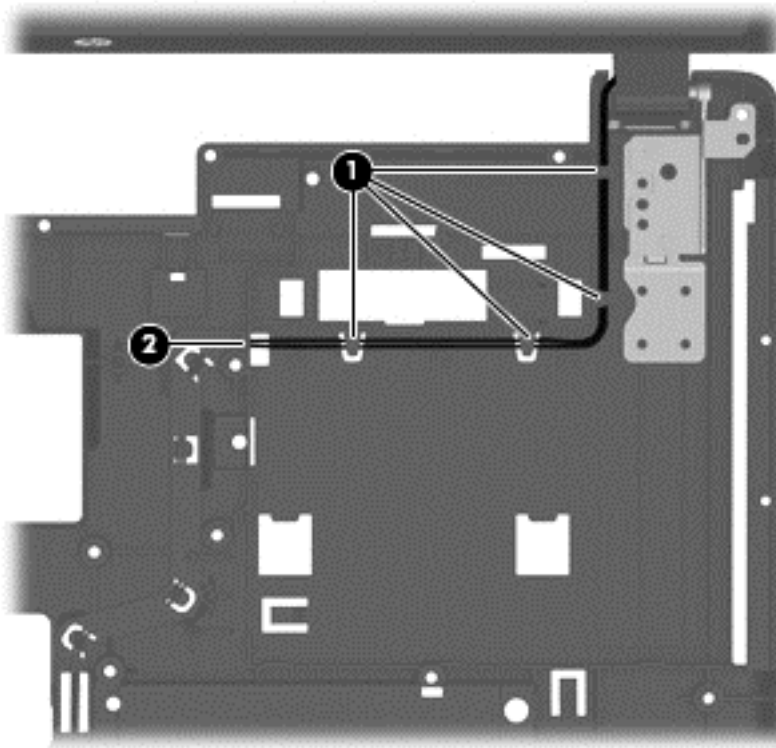

7. Remove the 3 Torx T8M2.5×4.0 screws **(1)** from the display hinges.

8. Lift the display assembly straight up and remove it **(2)**.

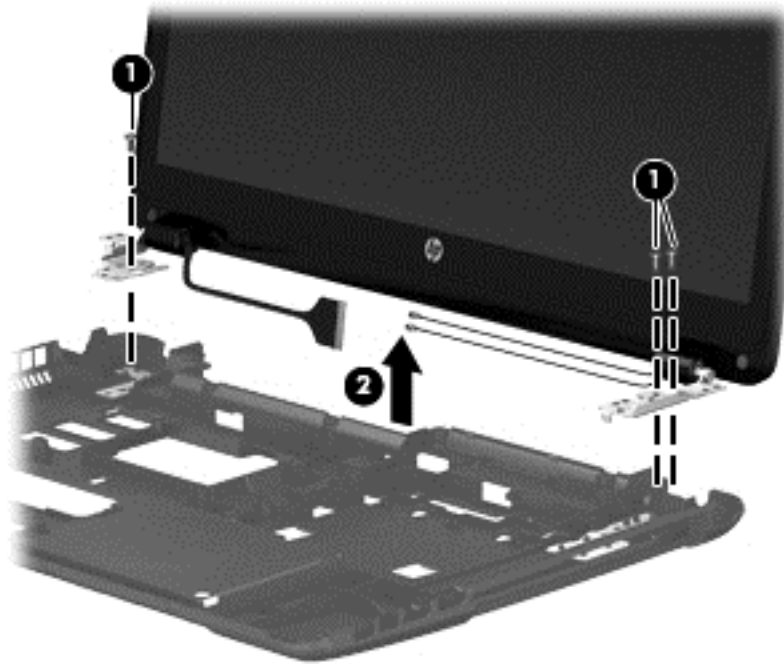

CAUTION: When installing the display assembly, be sure that the wireless antenna cables are routed and arranged properly.

Failure to properly route the antennas can result in degradation of the computer's wireless performance.

9. If you need to remove the hinge covers from the display hinges, squeeze and pull the covers straight up and off the display to remove them.

If you need to remove the hinge covers from the display hinges, pinch the top and bottom of the hinges and then pull the hinges straight up and off the display.

Display hinge covers are available in the Display Hinge Kit using spare part number 721940-001.

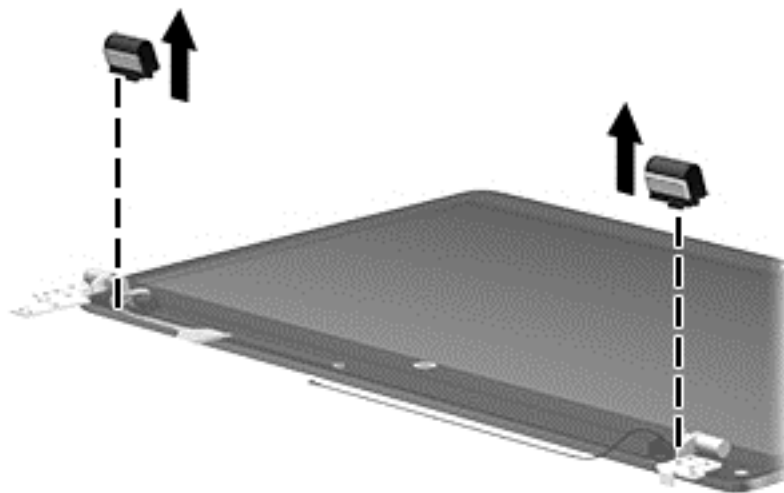

10. If you need to remove the display bezel, remove the 2 mylar screw covers **(1)** and the 2 Phillips PM2.5×4.0 screws **(2)** in the bottom corners of the display bezel.

11. Flex the top **(3)** of the bezel, the inside edges of the left and right sides **(4)**, and then the bottom **(5)** of the bezel until it disengages from the display enclosure.

 **NOTE:** Make sure the hinges are not bent (see hinge position in following image) when you remove the bezel.

12. Remove the display bezel **(6)**.

The display bezel is available using spare part number 721934-001 for models with a webcam and 721935-001 for models without a webcam. Display bezel mylar screw covers are available in the Rubber Kit, spare part number 721948-001.

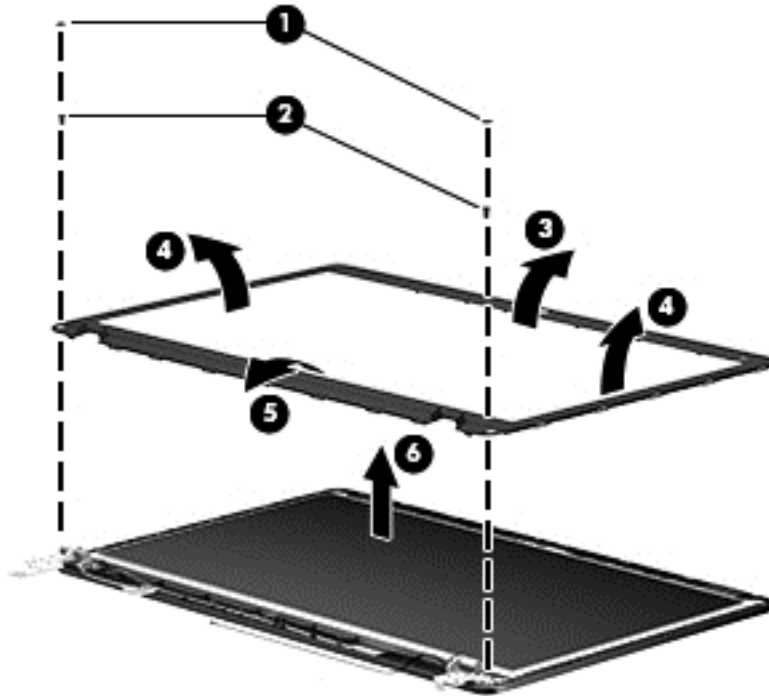

13. If it is necessary to replace the webcam or microphone module, disconnect the cable from the module (1), and then gently pull the module away from the double-sided tape on the display enclosure (2).

The webcam module is available using spare part number 721543-001, and the microphone module is available using spare part number 721526-001.

 **NOTE:** The removal and replacement procedure is the same for the webcam and microphone modules. The following image illustrates a webcam module.

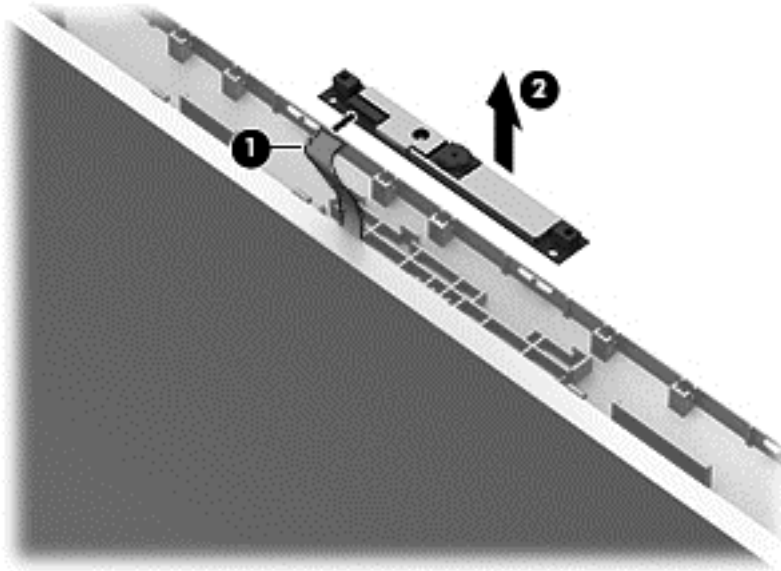

14. If it is necessary to replace the display hinges, remove the 4 Phillips PM2.5×3.0 screws (1) that secure the display hinges to the display enclosure.
15. Remove the display hinges from the display enclosure (2).

Display hinges are available in the Display Hinge Kit using spare part number 721940-001.

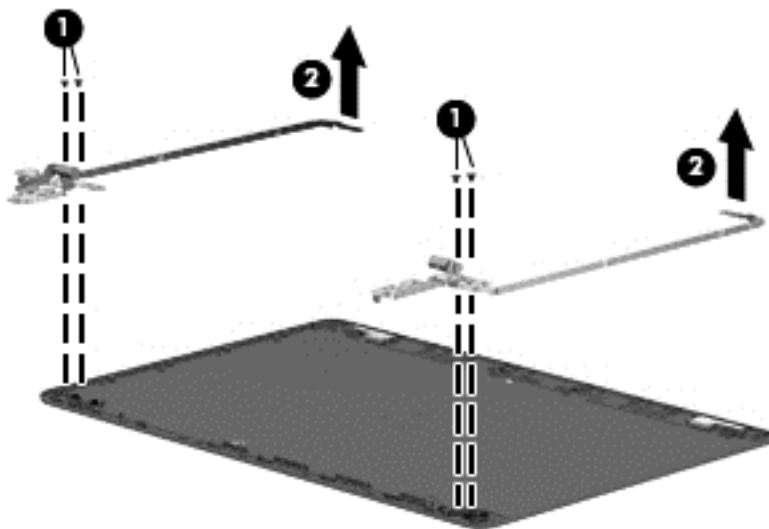

16. If it is necessary to remove the display panel from the enclosure, remove the 4 Phillips PM2.5×3.0 screws **(1)** that secure the panel to the display enclosure.
17. Rotate the top of the panel upward **(2)**, and then remove the display panel **(3)** from the enclosure.

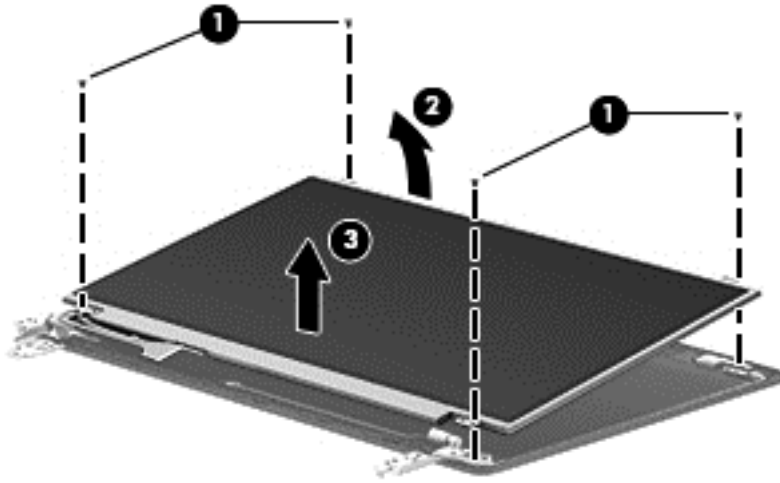

18. If it is necessary to remove the display/webcam cable assembly, disconnect the display panel cable from the rear of the display panel by lifting the tape **(1)** that covers the connector, and disconnecting the cable from the panel **(2)**.

The display/webcam cable assembly is available in the Cable Kit, spare part number 721936-001.

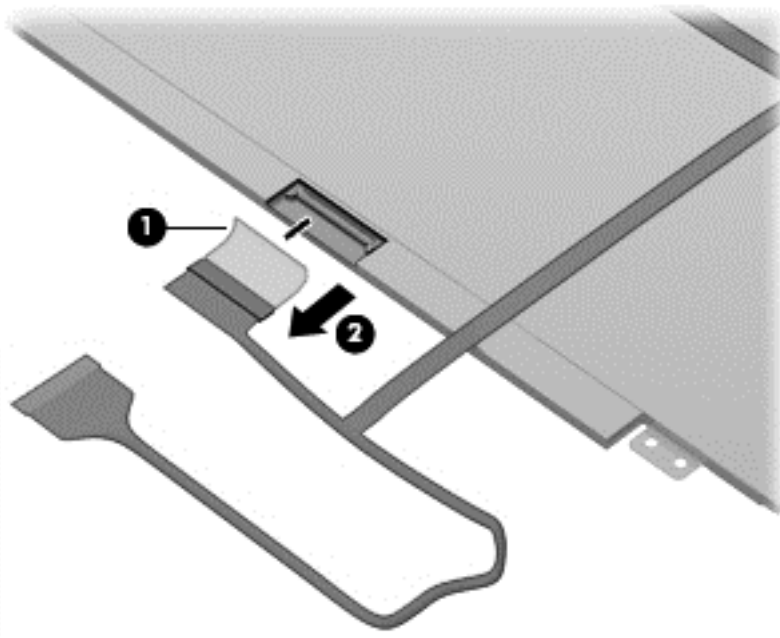

19. Lift the display/webcam cable assembly straight up and off the display panel.

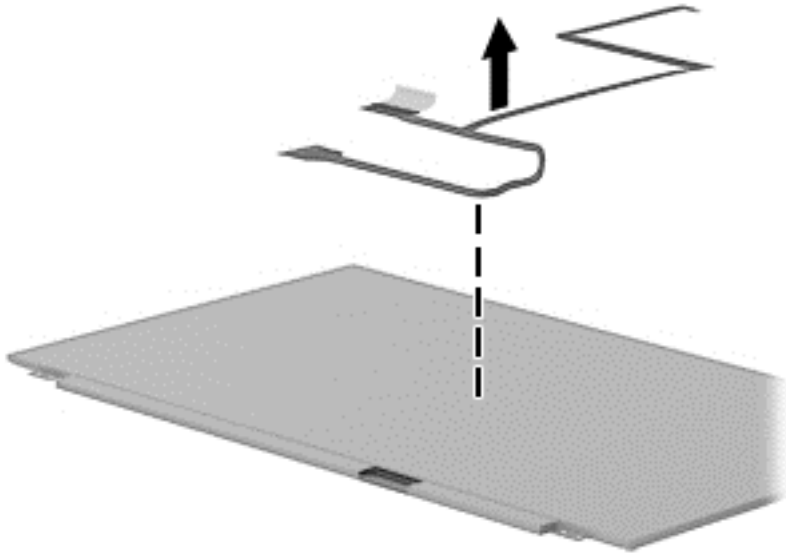

20. If it is necessary to remove the antennas from the display enclosure, remove the antennas from clips on each side of the enclosure (1), gently lift the WLAN transceivers (2) and the WWAN transceivers (3) (WWAN models only) to disengage them from the double-stick tape, and then lift the antennas from the display enclosure.

WLAN antennas are available using spare part number 721930-001. WWAN antennas are available using spare part number 721931-001.

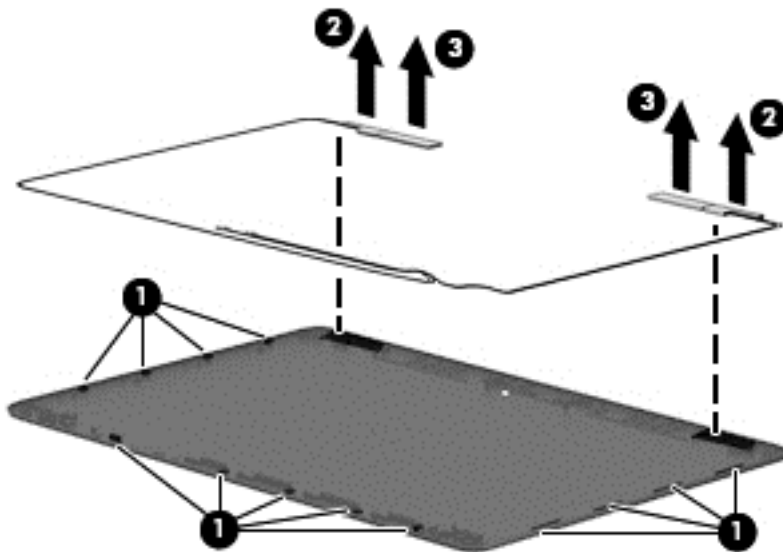

Reverse this procedure to reassemble and install the display assembly.

7 Computer Setup (BIOS), MultiBoot, and System Diagnostics in Windows 8

Using Computer Setup

Computer Setup, or Basic Input/Output System (BIOS), controls communication between all the input and output devices on the system (such as disk drives, display, keyboard, mouse, and printer). Computer Setup includes settings for the types of devices installed, the startup sequence of the computer, and the amount of system and extended memory.

 **NOTE:** Use extreme care when making changes in Computer Setup. Errors can prevent the computer from operating properly.

Starting Computer Setup

 **NOTE:** An external keyboard or mouse connected to a USB port can be used with Computer Setup only if USB legacy support is enabled.

To start Computer Setup, follow these steps:

1. Turn on or restart the computer, and then press **esc** while the “Press the ESC key for Startup Menu” message is displayed at the bottom of the screen.
2. Press **f10** to enter Computer Setup.

Navigating and selecting in Computer Setup

To navigate and select in Computer Setup, follow these steps:

1. Turn on or restart the computer, and then press **esc** while the “Press the ESC key for Startup Menu” message is displayed at the bottom of the screen.
 - To select a menu or a menu item, use the **tab** key and the keyboard arrow keys and then press **enter**, or use a pointing device to click the item.
 - To scroll up and down, click the up arrow or the down arrow in the upper-right corner of the screen, or use the up arrow key or the down arrow key on the keyboard.
 - To close open dialog boxes and return to the main Computer Setup screen, press **esc**, and then follow the on-screen instructions.

 **NOTE:** You can use either a pointing device (TouchPad, pointing stick, or USB mouse) or the keyboard to navigate and make selections in Computer Setup.

2. Press **f10** to enter Computer Setup.

To exit Computer Setup menus, choose one of the following methods:

- To exit Computer Setup menus without saving your changes:
Click the **Exit** icon in the lower-right corner of the screen, and then follow the on-screen instructions.
– or –
Use the **tab** key and the arrow keys to select **File > Ignore Changes and Exit**, and then press **enter**.
- To save your changes and exit Computer Setup menus:
Click the **Save** icon in the lower-right corner of the screen, and then follow the on-screen instructions.
– or –
Use the **tab** key and the arrow keys to select **File > Save Changes and Exit**, and then press **enter**.

Your changes go into effect when the computer restarts.

Restoring factory settings in Computer Setup

 **NOTE:** Restoring defaults will not change the hard drive mode.

To return all settings in Computer Setup to the values that were set at the factory, follow these steps:

1. Turn on or restart the computer, and then press **esc** while the “Press the ESC key for Startup Menu” message is displayed at the bottom of the screen.
2. Press **f10** to enter Computer Setup.
3. Use a pointing device or the arrow keys to select **File > Restore Defaults**.
4. Follow the on-screen instructions.
5. To save your changes and exit, click the **Save** icon in the lower-right corner of the screen, and then follow the on-screen instructions.

– or –

Use the arrow keys to select **File > Save Changes and Exit**, and then press **enter**.

Your changes go into effect when the computer restarts.

 **NOTE:** Your password settings and security settings are not changed when you restore the factory settings.

Updating the BIOS

Updated versions of the BIOS may be available on the HP website.

Most BIOS updates on the HP website are packaged in compressed files called *SoftPaqs*.

Some download packages contain a file named *Readme.txt*, which contains information regarding installing and troubleshooting the file.

Determining the BIOS version

To determine whether available BIOS updates contain later BIOS versions than those currently installed on the computer, you need to know the version of the system BIOS currently installed.

BIOS version information (also known as *ROM date* and *System BIOS*) can be displayed by pressing **fn+esc** (if you are already in Windows) or by using Computer Setup.

1. Start Computer Setup.
2. Use a pointing device or the arrow keys to select **File > System Information**.
3. To exit Computer Setup without saving your changes, click the **Exit** icon in the lower-right corner of the screen, and then follow the on-screen instructions.

– or –

Use the **tab** key and the arrow keys to select **File > Ignore Changes and Exit**, and then press **enter**.

Downloading a BIOS update

 **CAUTION:** To reduce the risk of damage to the computer or an unsuccessful installation, download and install a BIOS update only when the computer is connected to reliable external power using the AC adapter. Do not download or install a BIOS update while the computer is running on battery power, docked in an optional docking device, or connected to an optional power source. During the download and installation, follow these instructions:

Do not disconnect power on the computer by unplugging the power cord from the AC outlet.

Do not shut down the computer or initiate Sleep.

Do not insert, remove, connect, or disconnect any device, cable, or cord.

1. From the Start screen, select the HP Support Assistant app.
2. Select **Updates and tune-ups**, and then select **Check for HP updates now**.
3. At the download area, follow these steps:
 - a. Identify the most recent BIOS update and compare it to the BIOS version currently installed on your computer. Make a note of the date, name, or other identifier. You may need this information to locate the update later, after it has been downloaded to your hard drive.
 - b. Follow the on-screen instructions to download your selection to the hard drive.

If the update is more recent than your BIOS, make a note of the path to the location on your hard drive where the BIOS update is downloaded. You will need to access this path when you are ready to install the update.

 **NOTE:** If you connect your computer to a network, consult the network administrator before installing any software updates, especially system BIOS updates.

BIOS installation procedures vary. Follow any instructions that are displayed on the screen after the download is complete. If no instructions are displayed, follow these steps:

1. From the Start screen, type **e**, and then click **File Explorer**.
2. Click your hard drive designation. The hard drive designation is typically Local Disk (C:).
3. Using the hard drive path you recorded earlier, open the folder on your hard drive that contains the update.
4. Double-click the file that has an **.exe** extension (for example, *filename.exe*).

The BIOS installation begins.
5. Complete the installation by following the on-screen instructions.



NOTE: After a message on the screen reports a successful installation, you can delete the downloaded file from your hard drive.

Using MultiBoot

About the boot device order

As the computer starts, the system attempts to boot from enabled devices. The MultiBoot utility, which is enabled at the factory, controls the order in which the system selects a boot device. Boot devices can include optical drives, diskette drives, a network interface card (NIC), hard drives, and USB devices. Boot devices contain bootable media or files that the computer needs to start and operate properly.



NOTE: Some boot devices must be enabled in Computer Setup before they can be included in the boot order.

You can change the order in which the computer searches for a boot device by changing the boot order in Computer Setup. You can also press **esc** while the “Press the ESC key for Startup Menu” message is displayed at the bottom of the screen, and then press **f9**. Pressing **f9** displays a menu that shows the current boot devices and allows you to select a boot device. Or, you can use MultiBoot Express to set the computer to prompt you for a boot location each time the computer turns on or restarts.

Choosing Multi Boot preferences

You can use MultiBoot in the following ways:

- To set a new boot order that the computer uses each time it is turned on, by changing the boot order in Computer Setup.
- To dynamically choose the boot device, by pressing **esc** while the “Press the ESC key for Startup Menu” message is displayed at the bottom of the screen, and then pressing **f9** to enter the Boot Device Options menu.
- To use MultiBoot Express to set variable boot orders. This feature prompts you for a boot device each time the computer is turned on or restarted.

Setting a new boot order in Computer Setup

To start Computer Setup and set a boot device order that the computer uses each time it is turned on or restarted, follow these steps:

1. Turn on or restart the computer, and then press **esc** while the “Press the ESC key for Startup Menu” message is displayed at the bottom of the screen.
2. Press **f10** to enter Computer Setup.
3. Use a pointing device or the arrow keys to select the **Legacy Boot Order** list, and then press **enter**.
4. To move the device up in the boot order, use a pointing device to click the up arrow, or press the **+** key.
– or –
To move the device down in the boot order, use a pointing device to click the down arrow, or press the **-** key.
5. To save your changes and exit Computer Setup, click the **Save** icon in the lower-left corner of the screen, and then follow the on-screen instructions.

– or –

Use the arrow keys to select **File > Save Changes and Exit**, and then press **enter**.

Dynamically choosing a boot device using the f9 prompt

To dynamically choose a boot device for the current startup sequence, follow these steps:

1. Open the Select Boot Device menu by turning on or restarting the computer, and then pressing **esc** while the “Press the ESC key for Startup Menu” message is displayed at the bottom of the screen.
2. Press **f9**.
3. Use a pointing device or the arrow keys to select a boot device, and then press **enter**.

Setting a MultiBoot Express prompt

To start Computer Setup and set the computer to display the MultiBoot startup location menu each time the computer is started or restarted, follow these steps:

1. Turn on or restart the computer, and then press **esc** while the “Press the ESC key for Startup Menu” message is displayed at the bottom of the screen.
2. Press **f10** to enter Computer Setup.
3. Use a pointing device or the arrow keys to select **System Configuration > Boot Options**, and then press **enter**.
4. In the **MultiBoot Express Popup Delay (Sec)** field, enter the length of time in seconds that you want the computer to display the startup location menu before it defaults to the current MultiBoot setting. (When 0 is selected, the Express Boot startup location menu is not displayed.)
5. To save your changes and exit Computer Setup, click the **Save** icon in the lower-left corner of the screen, and then follow the on-screen instructions.

– or –

Use the arrow keys to select **File > Save Changes and Exit**, and then press **enter**.

Your changes go into effect when the computer restarts.

Entering MultiBoot Express preferences

When the Express Boot menu is displayed during startup, you have the following choices:

- To specify a boot device from the Express Boot menu, select your preference within the allotted time, and then press **enter**.
- To prevent the computer from defaulting to the current MultiBoot setting, press any key before the allotted time expires. The computer will not start until you select a boot device and press **enter**.
- To allow the computer to start according to the current MultiBoot settings, wait for the allotted time to expire

Using System Diagnostics

System Diagnostics allows you to run diagnostic tests to determine if the computer hardware is functioning properly. The following diagnostic tests may be available in System Diagnostics:

- **System Tune-Up**—This group of additional tests checks your computer to make sure that the main components are functioning correctly. System Tune-Up runs longer and more comprehensive tests on memory modules, hard drive SMART attributes, the hard drive surface, the battery (and battery calibration), video memory, and the WLAN module status.
- **Start-up test**—This test analyzes the main computer components that are required to start the computer.
- **Run-in test**—This test repeats the start-up test and checks for intermittent problems that the start-up test does not detect.
- **Hard disk test**—This test analyzes the physical condition of the hard drive, and then checks all data in every sector of the hard drive. If the test detects a damaged sector, it attempts to move the data to a good sector.
- **Memory test**—This test analyzes the physical condition of the memory modules. If it reports an error, replace the memory modules immediately.
- **Battery test**—This test analyzes the condition of the battery and calibrates the battery if necessary. If the battery fails the test, contact HP support to report the issue and purchase a replacement battery.
- **BIOS Management**—You can update or rollback the version of the BIOS on the system. Do not shut down or remove external power during the process. You will be given a confirmation screen before your BIOS is modified. Select **BIOS update**, **BIOS Rollback**, or **Back to main menu**.

You can view system information and error logs or select languages in the System Diagnostics window.

To start System Diagnostics:

1. Turn on or restart the computer. While the “Press the ESC key for Startup Menu” message is displayed in the lower-left corner of the screen, press **esc**. When the Startup Menu is displayed, press **f2**.
2. Click the diagnostic test you want to run, and then follow the on-screen instructions.



NOTE: If you need to stop a diagnostics test while it is running, press **esc**.

8 Setup Utility (BIOS) and System Diagnostics in Windows 7

Using Setup Utility

Setup Utility, or Basic Input/Output System (BIOS), controls communication between all the input and output devices on the system (such as disk drives, display, keyboard, mouse, and printer). Setup Utility includes settings for the types of peripherals installed, the startup sequence of the computer, and the amount of system and extended memory.

 **NOTE:** Use extreme care when making changes in Setup Utility. Errors can prevent the computer from operating properly.

Starting Setup Utility

 **NOTE:** An external keyboard or mouse connected to a USB port can be used with Setup Utility only if USB legacy support is enabled.

To start Setup Utility, follow these steps:

1. Turn on or restart the computer, and then press **esc** while the “Press the ESC key for Startup Menu” message is displayed at the bottom of the screen.
2. Press **f10** to enter Setup Utility.

Changing the language of Setup Utility

1. Start Setup Utility.
2. Use the arrow keys to select **System Configuration > Language**, and then press **enter**.
3. Use the arrow keys to select a language, and then press **enter**.
4. When a confirmation prompt with your language selected is displayed, press **enter**.
5. To save your change and exit Setup Utility, use the arrow keys to select **Exit > Exit Saving Changes**, and then press **enter**.

Your change takes effect immediately.

Navigating and selecting in Setup Utility

To navigate and select in Setup Utility, follow these steps:

1. Turn on or restart the computer, and then press **esc** while the “Press the ESC key for Startup Menu” message is displayed at the bottom of the screen.
 - To select a menu or a menu item, use the tab key and the keyboard arrow keys and then press **enter**, or use a pointing device to click the item.
 - To scroll up and down, click the up arrow or the down arrow in the upper-right corner of the screen, or use the up arrow key or the down arrow key.
 - To close open dialog boxes and return to the main Setup Utility screen, press **esc**, and then follow the on-screen instructions.
2. Press **f10** to enter Setup Utility.

To exit Setup Utility menus, choose one of the following methods:

- To exit Setup Utility menus without saving your changes, press the **esc** key, and then follow the on-screen instructions.
– or –
Use the arrow keys to select **Exit > Exit Discarding Changes**, and then press **enter**.
- To save your changes and exit Setup Utility menus, press **f10**, and then follow the on-screen instructions.
– or –
Use the tab key and the arrow keys to select **Exit > Exit Saving Changes**, and then press **enter**.

Your changes go into effect when the computer restarts.

Displaying system information

1. Start Setup Utility.
2. Select the **Main** menu. System information such as the system time and date, and identification information about the computer is displayed.
3. To exit Setup Utility without changing any settings, use the arrow keys to select **Exit > Exit Discarding Changes**, and then press **enter**.

Restoring factory settings in Setup Utility

 **NOTE:** Restoring defaults will not change the hard drive mode.

To return all settings in Setup Utility to the values that were set at the factory, follow these steps:

1. Turn on or restart the computer, and then press **esc** while the “Press the ESC key for Startup Menu” message is displayed at the bottom of the screen.
2. Press **f10** to enter Setup Utility.
3. Use the arrow keys to select **Exit > Load Setup Defaults**.
4. Follow the on-screen instructions.
5. To save your changes and exit, press **f10**, and then follow the on-screen instructions.

– or –

Use the arrow keys to select **Exit > Exit Saving Changes**, and then press **enter**.

Your changes go into effect when the computer restarts.

 **NOTE:** Your password settings and security settings are not changed when you restore the factory settings.

Exiting Setup Utility

- To exit Setup Utility and save your changes from the current session:
If the Setup Utility menus are not visible, press **esc** to return to the menu display. Then use the arrow keys to select **Exit > Exit Saving Changes**, and then press **enter**.
- To exit Setup Utility without saving your changes from the current session:
If the Setup Utility menus are not visible, press **esc** to return to the menu display. Then use the arrow keys to select **Exit > Exit Discarding Changes**, and then press **enter**.

Updating the BIOS

Updated versions of the BIOS may be available on the HP Web site.

Most BIOS updates on the HP Web site are packaged in compressed files called *SoftPaqs*.

Some download packages contain a file named *Readme.txt*, which contains information regarding installing and troubleshooting the file.

Determining the BIOS version

To determine whether available BIOS updates contain later BIOS versions than those currently installed on the computer, you need to know the version of the system BIOS currently installed.

BIOS version information (also known as *ROM date* and *System BIOS*) can be displayed by pressing **fn+esc** (if you are already in Windows) or by using Setup Utility.

1. Start Setup Utility (BIOS).
2. Use the arrow keys to select **Main**.
3. To exit Setup Utility (BIOS) without saving your changes, use the tab key and the arrow keys to select **Exit > Exit Discarding Changes**, and then press **enter**.

Downloading a BIOS update

 **CAUTION:** To reduce the risk of damage to the computer or an unsuccessful installation, download and install a BIOS update only when the computer is connected to reliable external power using the AC adapter. Do not download or install a BIOS update while the computer is running on battery power, docked in an optional docking device, or connected to an optional power source. During the download and installation, follow these instructions:

Do not disconnect power from the computer by unplugging the power cord from the AC outlet.

Do not shut down the computer or initiate Sleep or Hibernation.

Do not insert, remove, connect, or disconnect any device, cable, or cord.

1. **Windows 7**—Select **Start > Help and Support > Maintain**.
Windows XP—Select **Start > Help and Support**, and then select the software and drivers update.
2. Follow the on-screen instructions to identify your computer and access the BIOS update you want to download.
3. At the download area, follow these steps:
 - a. Identify the BIOS update that is later than the BIOS version currently installed on your computer. Make a note of the date, name, or other identifier. You may need this information to locate the update later, after it has been downloaded to your hard drive.
 - b. Follow the on-screen instructions to download your selection to the hard drive. Make a note of the path to the location on your hard drive where the BIOS update is downloaded. You will need to access this path when you are ready to install the update.

 **NOTE:** If you connect your computer to a network, consult the network administrator before installing any software updates, especially system BIOS updates.

BIOS installation procedures vary. Follow any instructions that are displayed on the screen after the download is complete. If no instructions are displayed, follow these steps:

1. **Windows 7**—Open Windows Explorer by selecting **Start > Computer**.
Windows XP—Open Windows Explorer by selecting **Start > My Computer**.
2. Double-click your hard drive designation. The hard drive designation is typically Local Disk (C:).
3. Using the hard drive path you recorded earlier, open the folder on your hard drive that contains the update.

4. Double-click the file that has an .exe extension (for example, *filename.exe*).

The BIOS installation begins.

5. Complete the installation by following the on-screen instructions.



NOTE: After a message on the screen reports a successful installation, you can delete the downloaded file from your hard drive.

Using System Diagnostics

System Diagnostics allows you to run diagnostic tests to determine if the computer hardware is functioning properly. The following diagnostic tests are available in System Diagnostics:

- **Start-up test**—This test analyzes the main computer components that are required to start the computer.
- **Run-in test**—This test repeats the start-up test and checks for intermittent problems that the start-up test does not detect.
- **Hard disk test**—This test analyzes the physical condition of the hard drive, and then checks all data in every sector of the hard drive. If the test detects a damaged sector, it attempts to move the data to a good sector.
- **Memory test**—This test analyzes the physical condition of the memory modules. If it reports an error, replace the memory modules immediately.
- **Battery test**—This test analyzes the condition of the battery. If the battery fails the test, contact HP support to report the issue and purchase a replacement battery.

You can also view system information and error logs in the System Diagnostics window.

To start System Diagnostics:

1. Turn on or restart the computer. While the “Press the ESC key for Startup Menu” message is displayed in the lower-left corner of the screen, press **esc**. When the Startup Menu is displayed, press **f2**.
2. Click the diagnostic test you want to run, and then follow the on-screen instructions.



NOTE: If you need to stop a diagnostics test while it is running, press **esc**.

9 Computer Setup (BIOS) and Advanced System Diagnostics in SUSE Linux

Computer Setup, or Basic Input/Output System (BIOS), controls communication between all the input and output devices on the system (such as disk drives, display, keyboard, mouse, and printer). Computer Setup includes settings for the types of peripherals installed, the startup sequence of the computer, and the amount of system and extended memory.

 **NOTE:** Use extreme care when making changes in Computer Setup. Errors can prevent the computer from operating properly.

Starting Computer Setup

 **NOTE:** An external keyboard or mouse connected to a USB port can be used with Computer Setup only if USB legacy support is enabled.

To start Computer Setup, follow these steps:

1. Turn on or restart the computer, and then press `esc` while the “Press the ESC key for Startup Menu” message is displayed at the bottom of the screen.
2. Press `f10` to enter Computer Setup.

Using Computer Setup

Navigating and selecting in Computer Setup

To navigate and select in Computer Setup, follow these steps:

1. Turn on or restart the computer, and then press `esc` while the “Press the ESC key for Startup Menu” message is displayed at the bottom of the screen.
 - To select a menu or a menu item, use the `tab` key and the keyboard arrow keys and then press `enter`, or use a pointing device to click the item.
 - To scroll up and down, click the up arrow or the down arrow in the upper-right corner of the screen, or use the up arrow key or the down arrow key.
 - To close open dialog boxes and return to the main Computer Setup screen, press `esc`, and then follow the on-screen instructions.

 **NOTE:** You can use either a pointing device (TouchPad, pointing stick, or USB mouse) or the keyboard to navigate and make selections in Computer Setup.

2. Press `f10` to enter Computer Setup.

To exit Computer Setup menus, choose one of the following methods:

- To exit Computer Setup menus without saving your changes, click the **Exit** icon in the lower-left corner of the screen, and then follow the on-screen instructions.
– or –
Use the **tab** key and the arrow keys to select **File > Ignore Changes and Exit**, and then press **enter**.
- To save your changes and exit Computer Setup menus, click the **Save** icon in the lower-left corner of the screen, and then follow the on-screen instructions.
– or –
Use the **tab** key and the arrow keys to select **File > Save Changes and Exit**, and then press **enter**.

Your changes go into effect when the computer restarts.

Restoring factory settings in Computer Setup

 **NOTE:** Restoring defaults will not change the hard drive mode.

To return all settings in Computer Setup to the values that were set at the factory, follow these steps:

1. Turn on or restart the computer, and then press **esc** while the “Press the ESC key for Startup Menu” message is displayed at the bottom of the screen.
2. Press **f10** to enter Computer Setup.
3. Use a pointing device or the arrow keys to select **File > Restore Defaults**.
4. Follow the on-screen instructions.
5. To save your changes and exit, click the **Save** icon in the lower-left corner of the screen, and then follow the on-screen instructions.

– or –

Use the arrow keys to select **File > Save Changes and Exit**, and then press **enter**.

Your changes go into effect when the computer restarts.

 **NOTE:** Your password settings and security settings are not changed when you restore the factory settings.

Updating the BIOS

Updated versions of the BIOS may be available on the HP Web site.

Most BIOS updates on the HP Web site are packaged in compressed files called *SoftPaqs*.

Some download packages contain a file named *Readme.txt*, which contains information regarding installing and troubleshooting the file.

Determining the BIOS version

To determine whether available BIOS updates contain later BIOS versions than those currently installed on the computer, you need to know the version of the system BIOS currently installed.

BIOS version information (also known as *ROM date* and *System BIOS*) can be displayed as follows:

1. Start Computer Setup.
2. Use a pointing device or the arrow keys to select **File > System Information**.
3. To exit Computer Setup without saving your changes, click the **Exit** icon in the lower-left corner of the screen, and then follow the on-screen instructions.

– or –

Use the **tab** key and the arrow keys to select **File > Ignore Changes and Exit**, and then press **enter**.

 **NOTE:** You can also determine the BIOS version by turning on or restarting the computer, pressing the **esc** key while the “Press the ESC key for Startup Menu” message is displayed at the bottom of the screen, and then pressing the **f1** key. Follow the on-screen instructions to exit this screen.

Downloading a BIOS update

 **CAUTION:** To reduce the risk of damage to the computer or an unsuccessful installation, download and install a BIOS update only when the computer is connected to reliable external power using the AC adapter. Do not download or install a BIOS update while the computer is running on battery power, docked in an optional docking device, or connected to an optional power source. During the download and installation, follow these instructions:

Do not disconnect power from the computer by unplugging the power cord from the AC outlet.

Do not shut down the computer or initiate Suspend or Hibernation.

Do not insert, remove, connect, or disconnect any device, cable, or cord.

1. Open your web browser. For U.S. support, go to <http://www.hp.com/go/contactHP>. For worldwide support, go to http://welcome.hp.com/country/us/en/wwcontact_us.html.
2. Follow the on-screen instructions to identify your computer and access the BIOS update you want to download.
3. Click the option for software and driver downloads, type your computer model number in the product box, and then press **enter**. Follow the on-screen instructions to identify your computer and access the BIOS update you want to download.
4. Click your specific product from the models listed.
5. Click the appropriate operating system.
6. Go to the BIOS section and download the BIOS software package.
7. Follow the installation instructions as provided with the downloaded BIOS software package.

 **NOTE:** After a message on the screen reports a successful installation, you can delete the downloaded file from your hard drive.

Using Advanced System Diagnostics

Advanced System Diagnostics allows you to run diagnostic tests to determine if the computer hardware is functioning properly. The following diagnostic tests are available in Advanced System Diagnostics:

- **Start-up test**—This test analyzes the main computer components that are required to start the computer.
- **Run-in test**—This test repeats the start-up test and checks for intermittent problems that the start-up test does not detect.

- **Hard disk test**—This test analyzes the physical condition of the hard drive, and then checks all data in every sector of the hard drive. If the test detects a damaged sector, it attempts to move the data to a good sector.
- **Memory test**—This test analyzes the physical condition of the memory modules. If it reports an error, replace the memory modules immediately.
- **Battery test**—This test analyzes the condition of the battery and calibrates the battery if necessary. If the battery fails the test, contact support to report the issue and purchase a replacement battery.
- **System Tune-Up**—This group of additional tests checks your computer to make sure that the main components are functioning correctly. System Tune-Up runs longer and more comprehensive tests on memory modules, hard drive SMART attributes, the hard drive surface, the battery (and battery calibration), video memory, and the WLAN module status.

You can view system information and error logs in the Advanced System Diagnostics window.

To start Advanced System Diagnostics:

1. Turn on or restart the computer. While the “Press the ESC key for Startup Menu” message is displayed in the lower-left corner of the screen, press **esc**. When the Startup Menu is displayed, press **f2**.
2. Click the diagnostic test you want to run, and then follow the on-screen instructions.



NOTE: If you need to stop a diagnostics test while it is running, press **esc**.

10 Backup and recovery in Windows 8

To protect your information, use Windows backup and restore utilities to back up individual files and folders, back up your entire hard drive, create system repair media (select models only) by using the installed optical drive (select models only) or an optional external optical drive, or create system restore points. In case of system failure, you can use the backup files to restore the contents of your computer.

From the Start screen, type `restore`, click **Settings**, and then select from the list of displayed options.

 **NOTE:** For detailed instructions on various backup and restore options, perform a search for these topics in HP Support Assistant. To access HP Support Assistant on the Start screen, select the **HP Support Assistant** app.

In case of system instability, HP recommends that you print the recovery procedures and save them for later use.

 **NOTE:** Windows includes the User Account Control feature to improve the security of your computer. You may be prompted for your permission or password for tasks such as installing software, running utilities, or changing Windows settings. Refer to HP Support Assistant. To access HP Support Assistant on the Start screen, select the **HP Support Assistant** app.

Backing up your information

Recovery after a system failure is as good as your most recent backup. You should create system repair media and your initial backup immediately after initial system setup. As you add new software and data files, you should continue to back up your system on a regular basis to maintain a reasonably current backup. The system repair media (select models only) are used to start up (boot) the computer and repair the operating system in case of system instability or failure. Your initial and subsequent backups allow you to restore your data and settings if a failure occurs.

On Start screen, type `backup`, click **Settings**, and then select **Save backup copies of your files with File History**.

You can back up your information to an optional external hard drive or a network drive.

Note the following when backing up:

- Store personal files in the Documents library, and back it up regularly.
- Back up templates that are stored in their associated programs.
- Save customized settings that appear in a window, toolbar, or menu bar by taking a screen shot of your settings. The screen shot can be a time-saver if you have to reset your preferences.

To create a backup using Backup and Restore:

 **NOTE:** Be sure that the computer is connected to AC power before you start the backup process.

 **NOTE:** The backup process may take over an hour, depending on file size and the speed of the computer.

1. From the Start screen, type `backup`, click **Settings**, and then select from the list of displayed options.
2. Follow the on-screen instructions to set up your backup, create a system image (select models only), or create system repair media (select models only).

Performing a system recovery

In case of system failure or instability, the computer provides the following tools to recover your files:

- **Windows recovery tools:** You can use Windows Backup and Restore to recover information you have previously backed up. You can also use Windows Automatic Repair to fix problems that might prevent Windows from starting correctly.
- **f11 recovery tools:** You can use the **f11** recovery tools to recover your original hard drive image. The image includes the Windows operating system and software programs installed at the factory.

 **NOTE:** If you are unable to boot (start up) your computer and you cannot use the system repair media you previously created (select models only), you must purchase Windows 8 operating system media to reboot the computer and repair the operating system. For additional information, see

Using the Windows recovery tools

To recover information you previously backed up:

- ▲ Access HP Support Assistant. To access HP Support Assistant on the Start screen, select the **HP Support Assistant** app.

To recover your information using Automatic Repair, follow these steps:

 **CAUTION:** Some Automatic Repair options will completely erase and reformat the hard drive. All files you have created and any software installed on the computer are permanently removed. When reformatting is complete, the recovery process restores the operating system, as well as the drivers, software, and utilities from the backup used for recovery.

1. If possible, back up all personal files.
2. If possible, check for the presence of the HP Recovery partition and the Windows partition.

From the Start screen, type **e**, and then click **File Explorer**.

– or –

From the Start screen, type **c**, and then select **Computer**.

 **NOTE:** If the Windows partition and the HP Recovery partition are not listed, you must recover your operating system and programs using the Windows 8 operating system DVD and the *Driver Recovery* media (both purchased separately). For additional information, see [Using Windows 8 operating system media \(purchased separately\) on page 106](#).

3. If the Windows partition and the HP Recovery partition are listed, restart the computer. After Windows has loaded, press and hold the **shift** key while clicking **Restart**.
4. Select **Troubleshoot**, then select **Advanced Options**, and then select **Automatic Repair**.
5. Follow the on-screen instructions.

 **NOTE:** For additional information on recovering information using the Windows tools, perform a search for these topics in HP Support Assistant. To access HP Support Assistant on the Start screen, select the **HP Support Assistant** app.

Using f11 recovery tools

 **CAUTION:** Using **f11** completely erases hard drive contents and reformats the hard drive. All files that you have created and any software that you have installed on the computer are permanently removed. The **f11** recovery tool reinstalls the operating system and HP programs and drivers that were installed at the factory. Software not installed at the factory must be reinstalled.

To recover the original hard drive image using **f11**:

1. If possible, back up all personal files.
2. If possible, check for the presence of the HP Recovery partition: From the Start screen, type **C**, and then select **Computer**.



NOTE: If the HP Recovery partition is not listed, you must recover your operating system and programs using the Windows 8 operating system media and the *Driver Recovery* media (both purchased separately). For additional information, see [Using Windows 8 operating system media \(purchased separately\) on page 106](#).

3. If the HP Recovery partition is listed, restart the computer, and then press **esc** while the “Press the ESC key for Startup Menu” message is displayed at the bottom of the screen.
4. Press **f11** while the “Press <F11> for recovery” message is displayed on the screen.
5. Follow the on-screen instructions.

Using Windows 8 operating system media (purchased separately)

To order a Windows 8 operating system DVD, go to <http://www.hp.com/support>, select your country or region, and follow the on-screen instructions. You can also order the DVD by calling support. For contact information, see the *Worldwide Telephone Numbers* booklet included with the computer.



CAUTION: Using a Windows 8 operating system media completely erases hard drive contents and reformat the hard drive. All files that you have created and any software that you have installed on the computer are permanently removed. When reformatting is complete, the recovery process helps you restore the operating system, as well as drivers, software, and utilities.

To initiate recovery using a Windows 8 operating system DVD:



NOTE: This process takes several minutes.

1. If possible, back up all personal files.
2. Restart the computer, and then insert the Windows 8 operating system DVD into the optical drive before the Windows operating system loads.
3. When prompted, press any keyboard key.
4. Follow the on-screen instructions.

After the repair is completed:

1. Eject the Windows 8 operating system media and then insert the *Driver Recovery* media.
2. Install the Hardware Enabling Drivers first, and then install Recommended Applications.

Using Windows Refresh for quick and easy recovery

When your computer is not working properly and you need to regain system stability, the Windows Refresh option allows you to start fresh and keep what is important to you.

 **IMPORTANT:** Refresh removes any traditional applications that were not originally installed on the system at the factory.

 **NOTE:** During Refresh, a list of removed traditional applications will be saved so that you have a quick way to see what you might need to reinstall. See HP Support Assistant for instructions on reinstalling traditional applications. To access HP Support Assistant on the Start screen, select the **HP Support Assistant** app.

 **NOTE:** You may be prompted for your permission or password when using Refresh. See HP Support Assistant for more information. To access HP Support Assistant on the Start screen, select the **HP Support Assistant** app.

To start Refresh:

1. On the Start screen, point to the far-right upper or lower corner of the screen to display the charms.
2. Click **Settings**.
3. Click **Change PC settings** in the bottom-right corner of the screen, and then select **General** from the PC settings screen.
4. Scroll the right-side choices down to display **Refresh your PC without affecting your files**.
5. Under **Refresh your PC without affecting your files**, select **Get started**, and follow the on-screen instructions.

Remove everything and reinstall Windows

Sometimes you want to perform detailed reformatting of your computer, or you want to remove personal information before you give away or recycle your computer. The process described in this section provides a speedy, simple way to return the computer to its original state. This option removes all personal data, apps, and settings from your computer, and reinstalls Windows.

 **IMPORTANT:** This option does not provide backups of your information. Before using this option, back up any personal information you wish to retain.

You can initiate this option by using the **f11** key or from the Start screen.

To use the **f11** key:

1. Press **f11** while the computer boots.
– or –
Press and hold **f11** as you press the power button.
2. Choose your language.
3. Choose your keyboard layout.
4. Select **Troubleshoot** from the boot options menu.
5. Select **Reset your PC**, and follow the on-screen instructions.

To use the Start screen:

1. On the Start screen, point to the far-right upper or lower corner of the screen to display the charms.
2. Click **Settings**.

3. Click **Change PC settings** in the bottom-right corner of the screen, and then select **General** from the PC settings screen.
4. Scroll the right-side choices down to display **Remove everything and reinstall Windows**.
5. Under **Remove everything and reinstall Windows**, select **Get started**, and follow the on-screen instructions.

Using HP Software Setup

HP Software Setup can be used to reinstall drivers or select software that has been corrupted or deleted from the system.

1. From the Start screen, type `HP Software Setup`, and select **Apps**.
2. Open HP Software Setup.
3. Follow the on-screen directions to reinstall drivers or select software.

11 Backup and recovery in Windows 7

To protect your information, use Windows Backup and Restore to back up individual files and folders, back up your entire hard drive (select models only), create system repair discs (select models only) with the installed optical drive (select models only) or an optional external optical drive, or create system restore points. In case of system failure, you can use the backup files to restore the contents of your computer.

Windows Backup and Restore provides the following options:

- Creating a system repair disc (select models only) by using the installed optical drive (select models only) or an optional external optical drive
- Backing up your information
- Creating a system image (select models only)
- Scheduling automatic backups (select models only)
- Creating system restore points
- Recovering individual files
- Restoring the computer to a previous state
- Recovering information using recovery tools



NOTE: For detailed instructions, perform a search for these topics in Help and Support. In case of system instability, HP recommends that you print the recovery procedures and save them for later use.

Windows includes the User Account Control feature to improve the security of your computer. You may be prompted for your permission or password for tasks such as installing software, running utilities, or changing Windows settings. See Help and Support for more information.

Creating recovery media with HP Recovery Disc Creator

HP Recovery Disc Creator is a software program that offers an alternative way to create recovery media. After you successfully set up the computer, you can create recovery media using HP Recovery Disc Creator. This recovery media performs a system recovery if the hard drive becomes corrupted. A system recovery reinstalls the original operating system and the software programs installed at the factory, and then configures the settings for the programs.

HP Recovery Disc Creator can create two kinds of recovery DVDs as follows:

- **Windows DVD**—Installs the operating system without additional drivers or applications.
Choosing this selection creates a DVD that restores the original operating system and the software programs installed at the factory.
- **Driver DVD**—Installs specific drivers and applications only, in the same way that the HP Software Setup utility installs drivers and applications.

Creating recovery media



NOTE: Operating system recovery media can be created only once. Thereafter, the option to create that media will not be available.

1. Select **Start > All Programs > Security and Protection > HP Recovery Disc Creator**.
2. Select **Driver DVD** or **Windows DVD**.
3. From the drop-down menu, select the drive for burning the recovery media.
4. Click the **Burn** button to start the burning process.

Backing up your information

Recovery after a system failure is as good as your most recent backup. Immediately after software setup, you should create system repair discs (select models only) using HP Recovery Disc Creator using the installed optical drive (select models only) or an optional external optical drive and back up your system. As you add new software and data files, you should continue to back up your system on a regular basis to maintain a reasonably current backup. The system repair discs (select models only) are used to start up (boot) the computer and repair the operating system in case of system instability or failure. Your initial and subsequent backups allow you to restore your data and settings if a failure occurs.

You can back up your information to an optional external hard drive, a network drive, or discs. Note the following when backing up:

- Store personal files in the Documents library, and back it up regularly.
- Back up templates that are stored in their associated programs.
- Save customized settings that appear in a window, toolbar, or menu bar by taking a screen shot of your settings. The screen shot can be a time-saver if you have to reset your preferences.
- When backing up to discs, use any of the following types of discs (purchased separately): CD-R, CD-RW, DVD+R, DVD+R DL, DVD-R, DVD-R DL, or DVD±RW. The discs you use will depend on the type of optical drive you are using.



NOTE: DVDs and DVDs with double-layer (DL) support store more information than CDs, so using them for backup reduces the number of recovery discs required.

- When backing up to discs, number each disc before inserting it into the external drive.

To create a backup using Backup and Restore:



NOTE: Be sure that the computer is connected to AC power before you start the backup process.

The backup process may take over an hour, depending on file size and the speed of the computer.

1. Select **Start > All Programs > Maintenance > Backup and Restore**.
2. Follow the on-screen instructions to set up your backup, create a system image (select models only), or create a system repair disc (select models only).

Performing a system recovery

In case of system failure or instability, the computer provides the following tools to recover your files:

- **Windows recovery tools:** You can use Windows Backup and Restore to recover information you have previously backed up. You can also use Windows Startup Repair to fix problems that might prevent Windows from starting correctly.
- **f11 recovery tools:** You can use the **f11** recovery tools to recover your original hard drive image. The image includes the Windows operating system and software programs installed at the factory.

 **NOTE:** If you are unable to boot (start up) your computer and you cannot use the system repair discs you previously created (select models only), you must purchase a Windows 7 operating system DVD to reboot the computer and repair the operating system. For additional information, see Using a Windows 7 operating system DVD (purchased separately) on page 41.

Using the Windows recovery tools

To recover information you previously backed up:

1. Select **Start > All Programs > Maintenance > Backup and Restore**.
2. Follow the on-screen instructions to recover your system settings, your computer (select models only), or your files.

To recover your information using Startup Repair, follow these steps:

 **CAUTION:** Using Startup Repair completely erases hard drive contents and reformats the hard drive. All files you have created and any software installed on the computer are permanently removed. When reformatting is complete, the recovery process restores the operating system, as well as the drivers, software, and utilities from the backup used for recovery.

1. If possible, back up all personal files.
2. If possible, check for the presence of the Windows partition and the HP Recovery partition.

To check for the Windows partition, select **Start > Computer**.

To check for the HP Recovery partition, click **Start**, right-click **Computer**, click **Manage**, and then click **Disk Management**.

 **NOTE:** If the HP Recovery partition has been deleted, the **f11** restore option will not function. You must recover your operating system and programs using the Windows 7 operating system DVD and the Driver Recovery disc (both purchased separately) if the Windows partition and the HP Recovery partition are not listed. For additional information, see Using a Windows 7 operating system DVD (purchased separately) on page 41.

3. If the Windows partition and the HP Recovery partition are listed, restart the computer, and then press **f8** before the Windows operating system loads.
4. Select **Startup Repair**.
5. Follow the on-screen instructions.

 **NOTE:** For additional information on recovering information using the Windows tools, perform a search for these topics in Help and Support.

Using f11 recovery tools

 **CAUTION:** Using f11 recovery tools completely erases hard drive contents and reformats the hard drive. All files you have created and any software installed on the computer are permanently removed. The f11 recovery tool reinstalls the operating system and HP programs and drivers that were installed at the factory. Software not installed at the factory must be reinstalled.

To recover the original hard drive image using f11:

1. If possible, back up all personal files.
2. If possible, check for the presence of the Windows partition and the HP Recovery partition.

Click **Start**, right-click **Computer**, click **Manage**, and then click **Disk Management**.



NOTE: If the HP Recovery partition is not listed, you must recover your operating system and

programs using the Windows 7 operating system DVD and the Driver Recovery disc (both purchased separately). For additional information, see Using a Windows 7 operating system DVD (purchased separately) on page 41.

3. If the HP Recovery partition is listed, restart the computer, and then press **esc** while the "Press the ESC key for Startup Menu" message is displayed at the bottom of the screen.
4. Press **f11** while the "Press <F11> for recovery" message is displayed on the screen.
5. Follow the on-screen instructions.

Using a Windows 7 operating system DVD (purchased separately)

To order a Windows 7 operating system DVD, go to the HP website. For U.S. support, go to <http://www.hp.com/go/contactHP>. For worldwide support, go to http://welcome.hp.com/country/us/en/wwcontact_us.html. You can also order the DVD by calling support. For contact information, see the Worldwide Telephone Numbers booklet included with the computer.

 **CAUTION:** Using a Windows 7 operating system DVD completely erases hard drive contents and reformats the hard drive. All files you have created and any software installed on the computer are permanently removed. When reformatting is complete, the recovery process helps you restore the operating system, as well as drivers, software, and utilities.

To initiate recovery using a Windows 7 operating system DVD:



NOTE: This process takes several minutes.

1. If possible, back up all personal files.
2. Restart the computer, and then insert the Windows 7 operating system DVD into the optical drive before the Windows operating system loads.
3. When prompted, press any keyboard key.
4. Follow the on-screen instructions.
5. Click **Next**.
6. Select **Repair your computer**.
7. Follow the on-screen instructions.

After the repair is completed:

1. Eject the Windows 7 operating system DVD, and then insert the *Driver Recovery disc*.
2. Install the Hardware Enabling Drivers first, and then install Recommended Applications.

12 Backup and Recovery in SUSE Linux

Recovery after a system failure is as good as your most recent backup. As you add new software and data files, you should continue to back up your system on a regular basis to maintain a reasonably current backup.

Backing up your information

You should back up your computer files on a regular schedule to maintain a current backup. You can manually back up your information to an optional external drive, a network drive, or discs. Back up your system at the following times:

- At regularly scheduled times
- Before the computer is repaired or restored
- Before you add or modify hardware or software

To back up your home directory files using **Backup Manager Settings**:

1. Select **Computer > More Applications > Tools > Backup Manager Settings**, and click **Backup my home directory**.
2. Click **Storage Destination Location**, and then select a location to back up your information.
3. Click **Schedule**, and then select a time schedule to perform backups at a regularly scheduled time.

To immediately back up your information, click the **Backup Now** check box.

 **NOTE:** Before you back up your information, be sure you have designated a location to save the backup files.

4. Click **Save and Backup** to start the backup and to save the backup settings.

To restore backup files:

1. Select **Computer > More Applications > Tools > Backup Manager Restore**.
2. Click **Backup Source**, and then select the location of the backup files.
3. Click **Restore Destination**, and then select the destination to restore the files.
4. Select the **Optical Disk** option.
5. Under **Restore Point**, click the time and date of the backup.

 **NOTE:** If multiple backups have been performed, click **Use the latest version** to restore the latest version.

6. Click **Restore** to start restoring the files, or click **Cancel** to cancel the operation.

Performing a system recovery

Recovery allows you to repair or restore the computer to its original factory state. You can create an HP Factory Image Restore DVD, using an installed or an external DVD±RW optical drive. You can also restore the computer to its factory condition from the HP dedicated recovery partition on the hard drive.

 **CAUTION:** Using Recovery completely erases hard drive contents and reformats the hard drive. All files you have created and any software installed on the computer are permanently removed. The recovery tool reinstalls the original operating system and HP programs and drivers that were installed at the factory. Software, drivers, and updates not installed by HP must be manually reinstalled. Personal files must be restored from a backup.

To restore the computer using the HP Factory Image Restore DVD, you must first create the recovery disc. To create the recovery disc:

 **NOTE:** HP recommends that you create the HP Factory Image Restore DVD in the event of a system failure.

1. Select **Computer > More Applications**.
2. In the left pane, click **Tools**, and then click **Create HP Factory Image Restore DVD** in the right pane.
3. Follow the on-screen instructions to create an image file to burn a recovery disc.

To restore the computer from the recovery disc, follow these steps:

1. If possible, back up all personal files.
2. Insert the HP Factory Image Restore DVD into the optical drive and restart the computer.
3. As the computer is restarting, press **f9** to open the Computer Setup boot option menu.
4. Press the down arrow to select **Restore SLED HP-BNB preload image** from the **Linux boot** menu, and then press **enter**.
5. Using the arrow keys, select **Yes** when prompted: **Do you want to start the System-Restore?**
6. Follow the on-screen instructions.

 **NOTE:** You can also restore the computer from the partition by restarting the computer, and then pressing the **f11** key.

If you are unable to boot (start up) your computer from the hard drive partition with the primary operating system or from the recovery partition, and you did not create a system recovery disc, you must purchase a *SUSE Linux Enterprise Desktop Operating System DVD* to reinstall the operating system. For additional information, see the *Worldwide Telephone Numbers* booklet.

13 Specifications

Computer specifications

	Metric	U.S.
Dimensions		
Length	25.6 cm	10.09 in
Width	37.5 cm	14.76 in
Height (front to rear)	2.3 to 2.9 cm	0.9 to 1.1 in
Weight		
Non-touchscreen (equipped with optical drive, 1 DIMM, SSD, WLAN module, webcam, 6 cell battery)	2.37 kg	5.22 lbs
Non-touchscreen (equipped with no optical drive, 1 DIMM, SSD, WLAN module, webcam, 6 cell battery)	2.26 kg	4.22 lbs
Touchscreen (equipped with optical drive, 1 DIMM, SSD, WLAN module, webcam, 6 cell battery)	2.65 kg	5.98 lbs
Touchscreen (equipped with no optical drive, 1 DIMM, SSD, WLAN module, webcam, 6 cell battery)	2.54 kg	5.60 lbs
Input power		
Operating voltage	19.0 V dc @ 4.74 A – 90 W or 18.5 V dc @ 3.5 A - 65 W	
Operating current	4.74 A or 3.5 A	
Temperature		
Operating (not writing to optical disc)	0°C to 35°C	32°F to 95°F
Operating (writing to optical disc)	5°C to 35°C	41°F to 95°F
Nonoperating	-20°C to 60°C	-4°F to 140°F
Relative humidity		
Operating	10% to 90%	
Nonoperating	5% to 95%	
Maximum altitude (unpressurized)		
Operating (14.7 to 10.1 psia)	-15 m to 3,048 m	50 ft to 10,000 ft
Nonoperating (14.7 to 4.4 psia)	-15 m to 12,192 m	-50 ft to 40,000 ft
Shock		
Operating	125 g, 2 ms, half-sine	
Nonoperating	200 g, 2 ms, half-sine	
Random vibration		

	Metric	U.S.
Operating	0.75 g zero-to-peak, 10 Hz to 500 Hz, 0.25 oct/min sweep rate	
Nonoperating	1.50 g zero-to-peak, 10 Hz to 500 Hz, 0.5 oct/min sweep rate	

NOTE: Applicable product safety standards specify thermal limits for plastic surfaces. The computer operates well within this range of temperatures.

39.6-cm (15.6-in), HD+ display specifications

	Metric	U.S.
Active diagonal size	39.6-cm	15.6-in
Resolution	1600x900 (HD+)	
Active area	309.399x173.952	
PPI	112	
Surface treatment	Anti-glare	
Contrast ratio	300:1 (typical)	
Response time	8 ms	
Brightness	200 nits (typical)	
Viewing angle	SVA	
Backlight	LED	
Luminance uniformity @ 13 points	1.4 (typ), 1.6 (max)	
Lifetime (1/2 luminance)	12,000 hours	
Color coordinate (white)	(0.313, 0.329)	
Color tolerance (White)	+/- 0.02	
Color tolerance (W, R, G, B)	+/- 0.03	
Color gamut	45% typical	

Hard drive specifications

	1-TB*	750-GB*	500-GB*	320-GB*
Dimensions				
Height	9.5 mm	9.5 mm	9.5 mm	9.5 mm
Width	70 mm	70 mm	70 mm	70 mm
Weight	115 g	115 g	101 g	101 g
Interface type	SATA	SATA	SATA	SATA
Transfer rate	100 MB/sec	100 MB/sec	100 MB/sec	100 MB/sec
Security	ATA security	ATA security	ATA security	ATA security
Seek times (typical read, including setting)				
Single track	1.4 ms	1.5 ms	3 ms	3 ms
Average	10 ms	11 ms	13 ms	13 ms
Maximum	12 ms	14 ms	24 ms	24 ms
Logical blocks	1,938,921,461	1,465,149,168	1,048,576,000	625,141,400
Disc rotational speed	5400 rpm	5400 rpm	7200 rpm or 5400 rpm	5400 rpm
Operating temperature	5°C to 55°C (41°F to 131°F)			
*1 GB = 1 billion bytes when referring to hard drive storage capacity. Actual accessible capacity is less. Actual drive specifications may differ slightly.				
NOTE: Certain restrictions and exclusions apply. Contact technical support for details.				

DVD±RW SuperMulti DL Drive specifications

Applicable disc	Read: CD-DA, CD+(E)G, CD-MIDI, CD-TEXT, CD-ROM, CD-ROM XA, MIXED MODE CD, CD-I, CD-I Bridge (Photo-CD, Video CD), Multisession CD (Photo-CD, CD-EXTRA, Portfolio, CD-R, CD-RW), CD-R, CD-RW, DVD-ROM (DVD-5, DVD-9, DVD-10, DVD-18), DVD-R, DVD-RW, DVD+R, DVD+RW, DVD-RAM	Write: CD-R and CD-RW DVD+R, DVD+RW, DVD-R, DVD-RW, DVD-RAM
Center hole diameter	1.5 cm (0.59 in)	
Disc diameter		
Standard disc	12 cm (4.72 in)	
Mini disc	8 cm (3.15 in)	
Disc thickness	1.2 mm (0.047 in)	
Track pitch	0.74 µm	
Access time	CD	DVD
Random	< 175 ms	< 230 ms
Full stroke	< 285 ms	< 335 ms
Audio output level	Line-out, 0.7 Vrms	
Cache buffer	2 MB	
Data transfer rate		
24X CD-ROM	3,600 KB/sec	
8X DVD-ROM	10,800 KB/sec	
24X CD-R	3,600 KB/sec	
16X CD-RW	2,400 KB/sec	
8X DVD+R	10,800 KB/sec	
4X DVD+RW	5,400 KB/sec	
8X DVD-R	10,800 KB/sec	
4X DVD-RW	5,400 KB/sec	
2.4X DVD+R(9)	2,700 KB/sec	
5X DVD-RAM	6,750 KB/sec	
Transfer mode	Multiword DMA Mode	
Startup time	< 15 seconds	
Stop time	< 6 seconds	

Blu-ray ROM DVD±RW SuperMulti DL Drive

Applicable disc	Read:	Write:	
	CD-DA, CD+(E)G, CD-MIDI, CDTEXT, CD-ROM, CD-ROM XA, MIXED MODE CD, CD-I, CD-I Bridge (Photo-CD, Video CD), Multisession CD (Photo-CD, CD-EXTRA, Portfolio, CD-R, CD-RW), CD-R, CD-RW, DVDROM (DVD-5, DVD-9, DVD-10, DVD-18), DVD-R, DVD-RW, DVD+R, DVD+RW, DVD-RAM, HD-ROM (Single Layer), HD-ROM (Dual Layer), HD DVD-R, HD DVD-R for Dual Layer, HD DVD-RW	CD-R and CD-RW DVD+R, DVD+R(9), DVD+RW, DVD-R, DVD-R(9), DVD-RW, DVD-RAM	
Access time	CD	DVD	HD
Random	170 ms	170 ms	230 ms
Cache buffer	8 MB		
Data transfer rate			
24X CD-ROM	3,600 KB/sec		
8X DVD	10,800 KB/sec		
24X CD-R	3,600 KB/sec		
16X CD-RW	2,400 KB/sec		
8X DVD+R	10,800 KB/sec		
4X DVD+RW	5,400 KB/sec		
8X DVD-R	10,800 KB/sec		
4X DVD-RW	5,400 KB/sec		
2.4X DVD+R(9)	2,700 KB/sec		
5X DVD-RAM	6,750 KB/sec		
1X BD-ROM	4,500 KB/sec		
1X BD-R read	4,500 KB/sec		
1X BD-RE read	4,500 KB/sec		
Transfer mode	Multiword DMA Mode		

DVD-ROM drive

Applicable disc	DVD-ROM (DVD-5, DVD-9, DVD-10, DVD-18, CD-ROM (Mode 1 and 2), CD Digital Audio, CD-XA ready (Mode 2, Form 1 and Form 2), CD-I (Mode 2, Form 1 and Form 2), CD-R, CD-RW, Photo CD (single and multisession), CD-Bridge
Center hole diameter	1.5 cm (0.59 in)
Disc diameter	
Standard disc	12 cm (4.72 in)
Mini disc	8 cm (3.15 in)

Disc thickness	1.2 mm (0.047 in)	
Track pitch	0.74 μ m	
Access time	CD	DVD
Random	< 100 ms	< 125 ms
Full Stroke	< 175 ms	< 225 ms
Audio output level	Line-out, 0.7 Vrms	
Cache buffer	512 KB	
Data transfer rate		
CD-R (24X)	3600 KB/s (150 KB/s at 1X CD rate)	
CD-RW (10X)	1500 KB/s (150 KB/s at 1X CD rate)	
CD-ROM (24X)	3,600 KB/sec	
DVD (8X)	3600 KB/s (150 KB/s at 1X CD rate)	
Multiword DMA mode 2	16.6 MB/s	
Startup time	< 10 seconds	
Stop time	< 3 seconds	

Specification information in Device Manager

Device Manager allows you to view and control the hardware attached to the computer, as well as provides hardware specification information.

You can also add hardware or modify device configurations using Device Manager.



NOTE: Windows 7 and Windows Vista include the User Account Control feature to improve the security of your computer. You may be prompted for your permission or password for tasks such as installing software, running utilities, or changing Windows settings. Refer to Windows Help and Support for more information.

After you open Device Manager, drill-down to a device and double-click it to access its properties.

To access Device Manager in Windows 8:

1. From the Start screen, type `control`, and then select **Control Panel**.
2. Select **System and Security**, and then in the System area, click **Device Manager**.

A list display all the devices installed in your computer.

To access Device Manager in Windows 7:

1. Select **Start > Computer > System properties**.
2. In the left pane, click **Device Manager**.

14 Statement of Volatility

The purpose of this document is to provide general information regarding non-volatile memory in industry-standards based HP Business Notebook PC systems and provide general instructions for restoring nonvolatile memory that can contain personal data after the system has been powered off and the hard drive has been removed.

HP Business Notebook PC products that use Intel®-based or AMD®-based system boards contain volatile DDR memory. The amount of nonvolatile memory present in the system depends upon the system configuration. Intel-based and AMD-based system boards contain nonvolatile memory subcomponents as originally shipped from HP assuming that no subsequent modifications have been made to the system and assuming that no applications, features, or functionality have been added to or installed on the system.

Following system shutdown and removal of all power sources from an HP Business Notebook PC system, personal data can remain on volatile system memory (DIMMs) for a finite period of time and will also remain in nonvolatile memory. The steps below will remove personal data from the notebook PC, including the nonvolatile memory found in Intel-based and AMD-based system boards. Some of these steps are disclosed in the Maintenance & Service Guides available for HP PC products available on the product support pages at www.hp.com.

1. Follow steps (a) through (i) below to restore the nonvolatile memory that can contain personal data. Restoring or reprogramming nonvolatile memory that does not store personal data is neither necessary nor recommended.
 - a. Enter BIOS (F10) Setup by powering on the system and pressing **F10** when prompted near the bottom of the display, or press the **ESC** key to display the start up menu, then press **F10**. If the system has a BIOS administrator password, enter the password at the prompt.
 - b. Select the **File** menu, then **Restore Defaults**.
 - c. Select the **System Configuration** menu, then **Restore Security Defaults**.
 - d. If an asset or ownership tag is set, select the **Security** menu and scroll down to the **Utilities** menu. Select **System IDs**, and then select the tag that has been set. Press the spacebar once to clear the tag, then press **Enter** to return to the prior menu.
 - e. If a DriveLock password is set, select the **Security** menu, scroll down to **DriveLock**, then select **DriveLock password**. Select the desired hard drive. Click **Disable protection**, enter the existing master DriveLock password, then press **Enter** to confirm and return to the prior menu. Repeat this procedure if more than one hard drive has a DriveLock password.
 - f. If an Automatic DriveLock password is set, select the **Security** menu, scroll down to **Automatic DriveLock**, then select the desired hard drive and disable protection. Repeat this procedure if more than one hard drive has an Automatic DriveLock password.
 - g. Select the **File** menu, then **Reset BIOS Security to factory default**. Click **yes** at the warning message.
 - h. Select the **File** menu, then **Save Changes and Exit**.
 - i. Reboot the system. If the system has a Trusted Platform Module (TPM) and/or fingerprint sensor, one or two prompts will appear. One to clear the TPM and the other to Reset Fingerprint Sensor; press **F1** to accept or **F2** to reject.

If the HP notebook model number ends in a 'p' or 'w' and includes Intel® Centrino with VPro™, reboot the PC and enter BIOS Setup by pressing **F10** when prompted. Select **System**

Configuration, then **AMT Options**. Then select **Unconfigure AMT** on next boot. Select **Save** then **Yes**. Select the **File** menu, and then select **Save Changes and Exit**. Reboot the system and confirm that you want to unconfigure AMT.

- j. If the optional Intel® Anti-Theft Technology (AT) was activated, contact the provider to deactivate it.
 - k. If the optional Absolute® Software Computrace® management and tracking service was activated on the notebook PC, contact the provider to deactivate it.
 - l. Remove all power and system batteries for at least 24 hours.
2. Remove and retain the storage drive or clear the contents of the drive.

a. Hard Disk Drive (HDD)

Clear the HDD contents by using the HP Disk Sanitizer® utility or a third party application that, ideally, is U.S. Department of Defense (DOD) 5220.22-M approved.

To run HP Disk Sanitizer, enter BIOS Setup by powering on the system and pressing **F10** when prompted near the bottom of the display, or press **ESC** to display the start up menu, then press **F10**. Select the **Security** menu and scroll down to the **Utilities** menu. Select **Disk Sanitizer** and select the desired drive. For a higher level of protection, select **Optimum**.



NOTE: This process will take a long time, and the amount of time varies based on the hard drive capacity.

b. Solid State Drive (SSD)

Clear the SSD contents by using the BIOS Setup Secure Erase command option, or by using a third party utility designed to erase data from an SSD. To run Secure Erase, enter BIOS Setup by powering on the system and pressing **F10** when prompted near the bottom of the display. Select the **Security** menu and scroll down to the **Utilities** menu. Select **Secure Erase** and select the desired hard drive.

Non-volatile memory usage

Non Volatile Memory Type	Amount (Size)	Does this memory store customer data?	Does this memory retain data when power is removed?	What is the purpose of this memory?	How is data input into this memory?	How is this memory write protected?
Real Time Clock (RTC) battery backed-up CMOS configuration memory (CMOS)	256 Bytes	No	Yes	Stores system date and time and limited keyboard controller data.	Using the F10 Setup utility or changing the Microsoft® Windows® date & time.	This memory is not write-protected. HP recommends password protecting the F10 Setup utility.
Controller (NIC) EEPROM	64 Kbytes (not customer accessible)	No	Yes	Store NIC configuration and NIC firmware.	Using a utility from the NIC vendor that can be run from DOS.	A utility is required to write data to this memory and is available from NIC vendor. Writing data to this ROM in an inappropriate manner will render the NIC nonfunctional.
Keyboard ROM	64 Kbytes (not customer accessible)	No	Yes	Stores firmware code (keyboard, mouse, & battery management).	Programmed at the factory. Code is updated when the system BIOS is updated.	A utility is required for writing data to this memory and is available on the HP website. Writing data to this ROM in an inappropriate manner can render the PC nonfunctional.
DIMM Serial Presence Detect (SPD) configuration data	256 Bytes per memory module, 128 Bytes programmable (not customer accessible)	No	Yes	Stores memory module information.	Programmed by the memory vendor.	Data cannot be written to this memory when the module is installed in a PC. The specific write protection method varies by memory vendor.
System BIOS	4 to 5 MBytes	Yes	Yes	Store system BIOS code and PC configuration data.	System BIOS code is programmed at the factory. Code is updated when the system BIOS is updated. Configuration data and settings are input using the F10 setup utility or a custom utility.	A utility is required for writing data to this memory and is available on the HP website. Writing data to this ROM in an inappropriate manner can render the PC nonfunctional.
Intel Management Engine Firmware (present only in models ending in a 'p' or 'w' or with Intel Centrino Pro technology)	1.5 or 5MByte	Yes	Yes	Stores Management Engine Code, Settings, Provisioning Data and iAMT third party data store.	Management Engine Code is programmed at the factory. Code is updated via Intel secure firmware update utility. Unique Provisioning Data can be entered at the factory or by an administrator using the Management Engine (MEBx) setup utility. The	The Intel chipset is configured to enforce HW protection to block all direct read/write access to this area. An Intel utility is required for updating the firmware. Only firmware updates digitally signed by

					third party data store contents can be populated by a remote management console or local applications registered by an administrator to have access to the space.	Intel can be applied using this utility.
Bluetooth flash	2Mbit	No	Yes	Stores Bluetooth configuration and firmware.	Programmed at the factory. Tools for writing data to this memory are not publicly available but can be obtained from the silicon vendor.	A utility is required for writing data to this memory and is made available through newer versions of the driver if the flash requires an upgrade.
802.11 WLAN EEPROM	4kb to 8kb	No	Yes	Stores configuration and calibration data.	Programmed at the factory. Tools for writing data to this memory are not made public.	A utility is required for writing data to this memory and is typically not made available to the public unless a firmware upgrade is necessary to address a unique issue.
Web camera	64K bit	No	Yes	Store Web Cam configuration and firmware.	Using a utility from the device manufacturer that can be run from Windows.	A utility is required for writing data to this memory and is typically not made available to the public unless a firmware upgrade is necessary to address a unique issue.
Fingerprint reader	512kByte Flash	Yes	Yes	Stores fingerprint templates.	By enrolling in HP ProtectTools Security Manager.	Only a digitally signed application can make the call to write to the flash.

Questions and answers

1. How can the BIOS settings be restored (returned to factory settings)?

- a. Turn on or restart the computer and press **F10** when prompted near the bottom of the display.
- b. Select **File**, then select **Restore defaults**.
- c. Follow the on-screen instructions.
- d. Select **File**, save changes and exit, then press **Enter**.

2. What kind of configuration data is stored on the DIMM Serial Presence Detect (SPD) memory module? How would this data be written?

The DIMM SPD memory contains information about the memory module such as size, serial number, data width, speed/timing, voltage and thermal information. This information is written by the module manufacturer and stored on an EEPROM. This EEPROM cannot be written to when the memory module is installed in a PC. Third party tools do exist that can write to the EEPROM when the memory module is not installed in a PC. There are various third party tools available to read SPD memory.

3. Does the “Firmware Hub for System BIOS” contain the BIOS program? Is this chip writable, and if so how?

The Firmware Hub does contain the BIOS program and is writable. A utility is required to perform the write function.

4. In some PC systems, the Firmware Hub for System BIOS is a flash memory chip so that updates can be written by the customer. Is this true for these BIOS chips?

Yes, they are flash memory chips.

5. What is meant by “Restore the nonvolatile memory found in Intel-based system boards”?

This relates to clearing the Real Time Clock (RTC) CMOS memory that contains PC configuration data.

6. Does resetting the CMOS configuration memory return the PC back to factory defaults?

The process of resetting the CMOS will return certain system settings to factory default but will not reset many of the system data and configuration defaults to their factory settings. To return these system data and configuration defaults to factory settings, refer to question and answer 1 and follow the instructions for returning the BIOS settings to factory defaults.

15 Power cord set requirements

The wide-range input feature of the computer permits it to operate from any line voltage from 100 to 120 volts ac, or from 220 to 240 volts ac.

The 3-conductor power cord set included with the computer meets the requirements for use in the country or region where the equipment is purchased.

Power cord sets for use in other countries and regions must meet the requirements of the country or region where the computer is used.

Requirements for all countries and regions

The following requirements are applicable to all countries and regions:

- The length of the power cord set must be at least **1.5 m** (5.0 ft) and no more than **2.0 m** (6.5 ft).
- All power cord sets must be approved by an acceptable accredited agency responsible for evaluation in the country or region where the power cord set will be used.
- The power cord sets must have a minimum current capacity of 10 A and a nominal voltage rating of 125 or 250 V ac, as required by the power system of each country or region.
- The appliance coupler must meet the mechanical configuration of an EN 60 320/IEC 320 Standard Sheet C13 connector for mating with the appliance inlet on the back of the computer.

Requirements for specific countries and regions

Country/region	Accredited agency	Applicable note number
Argentina	IRAM	1
Australia	SAA	1
Austria	OVE	1
Belgium	CEBEC	1
Brazil	ABNT	1
Canada	CSA	2
Chile	IMQ	1
Denmark	DEMKO	1
Finland	FIMKO	1
France	UTE	1
Germany	VDE	1
India	ISI	1
Israel	SII	1
Italy	IMQ	1

Country/region	Accredited agency	Applicable note number
Japan	JIS	3
The Netherlands	KEMA	1
New Zealand	SANZ	1
Norway	NEMKO	1
The People's Republic of China	CCC	4
Saudi Arabia	SASO	7
Singapore	PSB	1
South Africa	SABS	1
South Korea	KTL	5
Sweden	SEMKO	1
Switzerland	SEV	1
Taiwan	BSMI	6
Thailand	TISI	1
The United Kingdom	ASTA	1
The United States	UL	2

1. The flexible cord must be Type H05VV-F, 3-conductor, 0.75mm² conductor size. Power cord set fittings (appliance coupler and wall plug) must bear the certification mark of the agency responsible for evaluation in the country or region where it will be used.
2. The flexible cord must be Type SVT/SJT or equivalent, No. 18 AWG, 3-conductor. The wall plug must be a two-pole grounding type with a NEMA 5-15P (15 A, 125 V ac) or NEMA 6-15P (15 A, 250 V ac) configuration. CSA or C-UL mark. UL file number must be on each element.
3. The appliance coupler, flexible cord, and wall plug must bear a "T" mark and registration number in accordance with the Japanese Dentori Law. The flexible cord must be Type VCTF, 3-conductor, 0.75mm² or 1.25mm² conductor size. The wall plug must be a two-pole grounding type with a Japanese Industrial Standard C8303 (7 A, 125 V ac) configuration.
4. The flexible cord must be Type RVV, 3-conductor, 0.75mm² conductor size. Power cord set fittings (appliance coupler and wall plug) must bear the CCC certification mark.
5. The flexible cord must be Type H05VV-F 3X0.75mm² conductor size. KTL logo and individual approval number must be on each element. Corset approval number and logo must be printed on a flag label.
6. The flexible cord must be Type HVCTF 3X1.25mm² conductor size. Power cord set fittings (appliance coupler, cable, and wall plug) must bear the BSMI certification mark.
7. For 127 V ac, the flexible cord must be Type SVT or SJT 3 x 18 AWG, with plug NEMA 5-15P (15 A, 125 V ac), with UL and CSA or C-UL marks. For 240 V ac, the flexible cord must be Type H05VV-F 3X0.75/1.00mm² conductor size, with plug BS 1363/A with BSI or ASTA marks.

16 Recycling

Battery

When a non-rechargeable or rechargeable battery has reached the end of its useful life, do not dispose of the battery in general household waste. Follow the local laws and regulations in your area for battery disposal.

HP encourages customers to recycle used electronic hardware, HP original print cartridges, and rechargeable batteries. For more information about recycling programs, see the HP Web site at <http://www.hp.com/recycle>.

Display

⚠ WARNING! The backlight contains mercury. Exercise caution when removing and handling the backlight to avoid damaging this component and causing exposure to the mercury.

⚠ CAUTION: The procedures in this chapter can result in damage to display components. The only components intended for recycling purposes are the LCD panel and the backlight. When you remove these components, handle them carefully.

📄 NOTE: Materials Disposal. This HP product contains mercury in the backlight in the display assembly that might require special handling at end-of-life. Disposal of mercury may be regulated because of environmental considerations. For disposal or recycling information, contact your local authorities, or see the Electronic Industries Alliance (EIA) Web site at <http://www.eiae.org>.

This section provides disassembly instructions for the display assembly. The display assembly must be disassembled to gain access to the backlight **(1)** and the liquid crystal display (LCD) panel **(2)**.

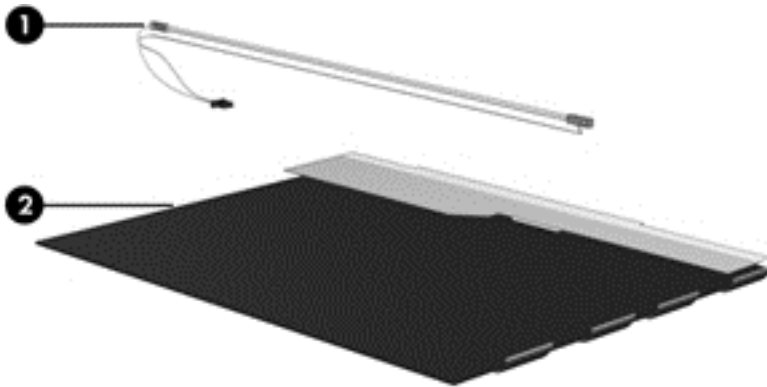

📄 NOTE: The procedures provided in this chapter are general disassembly instructions. Specific details, such as screw sizes, quantities, and locations, and component shapes and sizes, can vary from one computer model to another.

Perform the following steps to disassemble the display assembly:

1. Remove all screw covers **(1)** and screws **(2)** that secure the display bezel to the display assembly.

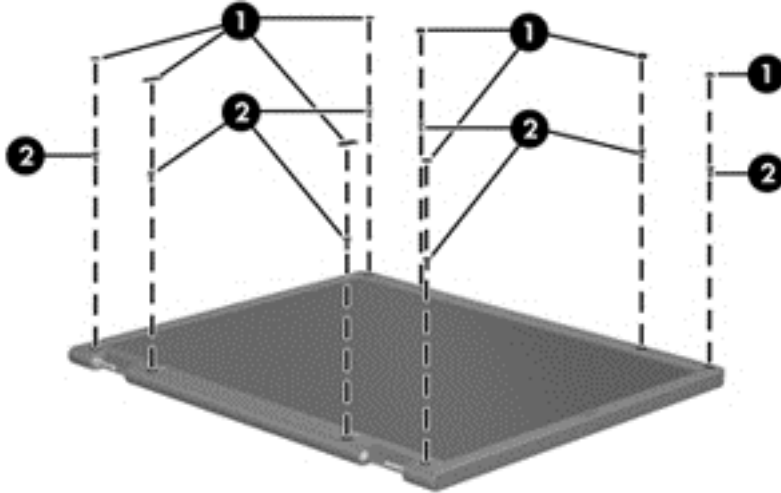

2. Lift up and out on the left and right inside edges **(1)** and the top and bottom inside edges **(2)** of the display bezel until the bezel disengages from the display assembly.

3. Remove the display bezel **(3)**.

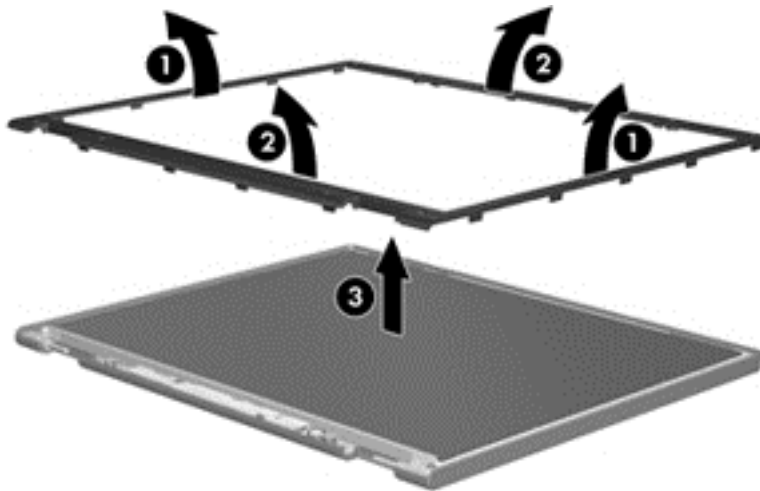

4. Disconnect all display panel cables **(1)** from the display inverter and remove the inverter **(2)**.

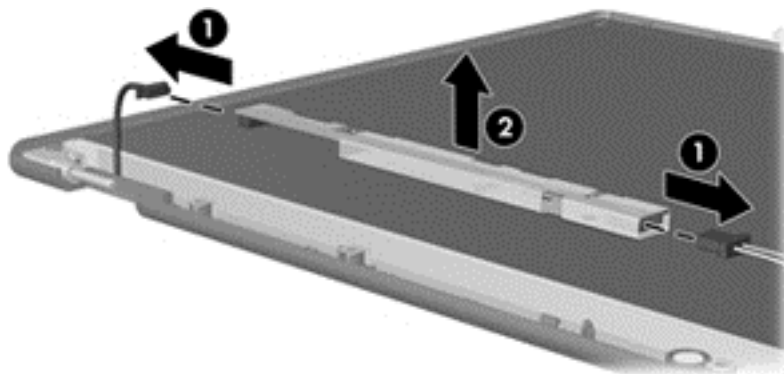

5. Remove all screws **(1)** that secure the display panel assembly to the display enclosure.
6. Remove the display panel assembly **(2)** from the display enclosure.

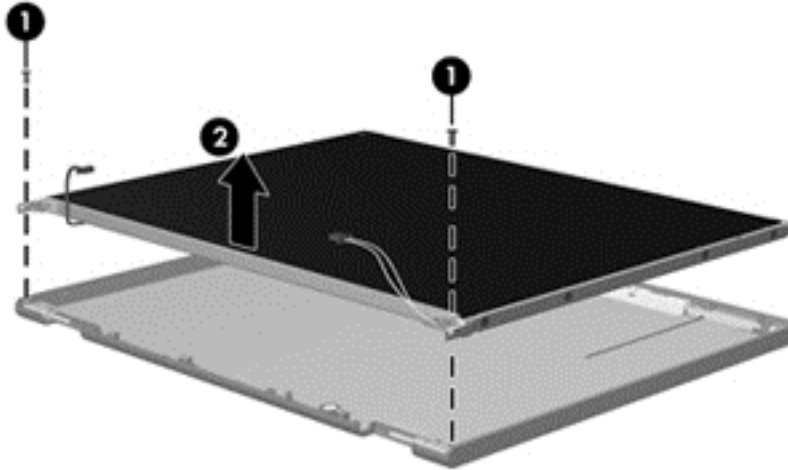

7. Position the display panel assembly upside-down.
8. Remove all screws that secure the display panel frame to the display panel.

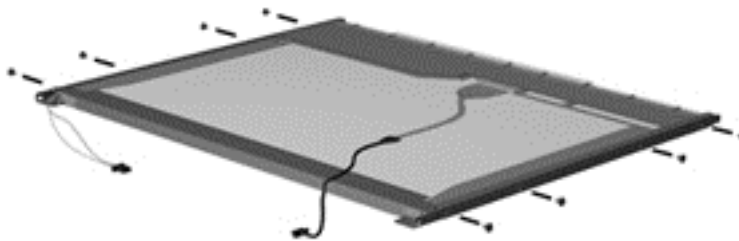

9. Use a sharp-edged tool to cut the tape **(1)** that secures the sides of the display panel to the display panel frame.
10. Remove the display panel frame **(2)** from the display panel.

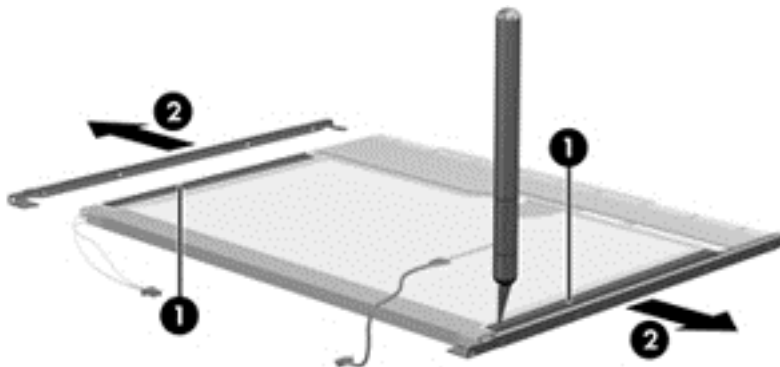

11. Remove the screws **(1)** that secure the backlight cover to the display panel.

12. Lift the top edge of the backlight cover (2) and swing it outward.

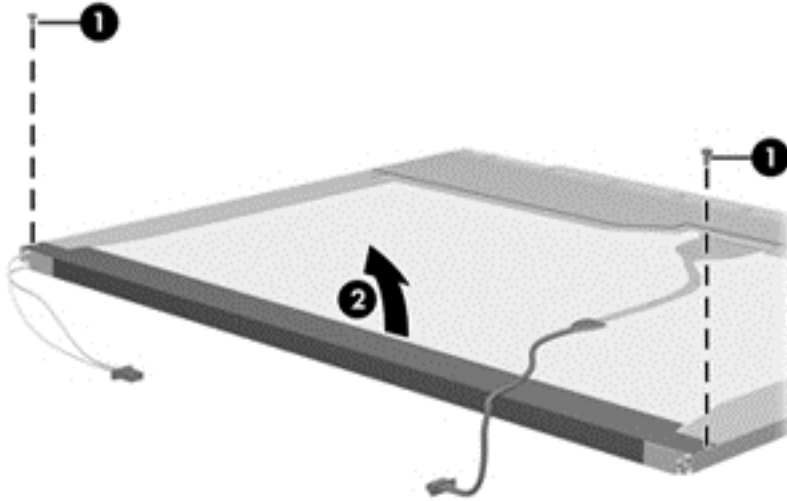

13. Remove the backlight cover.
14. Position the display panel right-side up.
15. Remove the backlight cables (1) from the clip (2) in the display panel.

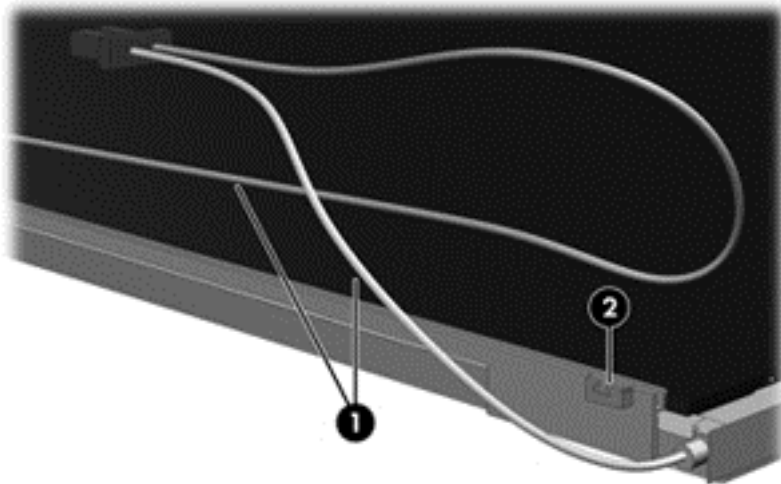

16. Position the display panel upside-down.

⚠ WARNING! The backlight contains mercury. Exercise caution when removing and handling the backlight to avoid damaging this component and causing exposure to the mercury.

17. Remove the backlight frame from the display panel.

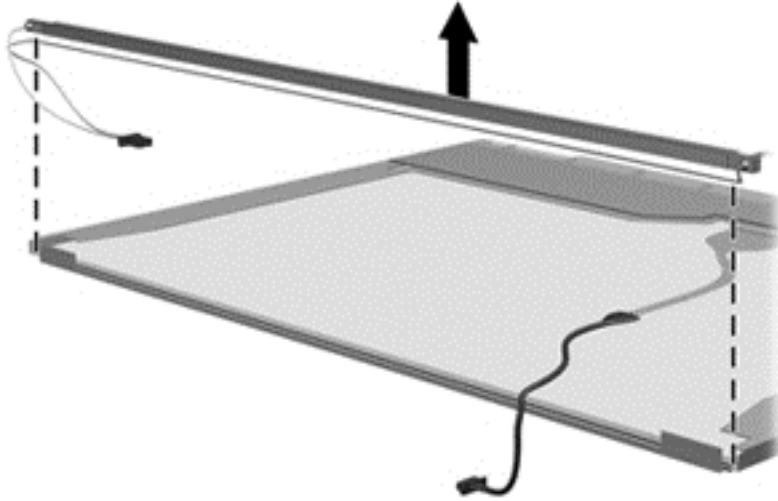

18. Remove the backlight from the backlight frame.

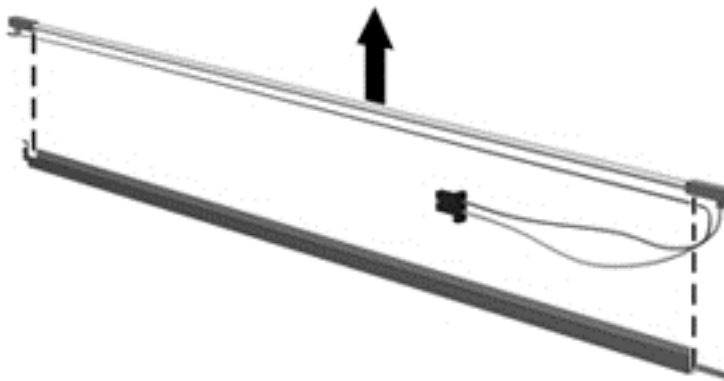

19. Disconnect the display panel cable (1) from the LCD panel.
20. Remove the screws (2) that secure the LCD panel to the display rear panel.
21. Release the LCD panel (3) from the display rear panel.
22. Release the tape (4) that secures the LCD panel to the display rear panel.

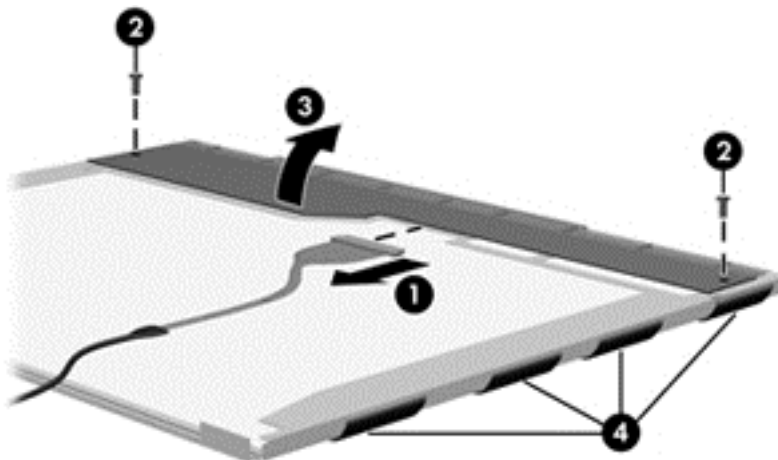

23. Remove the LCD panel.

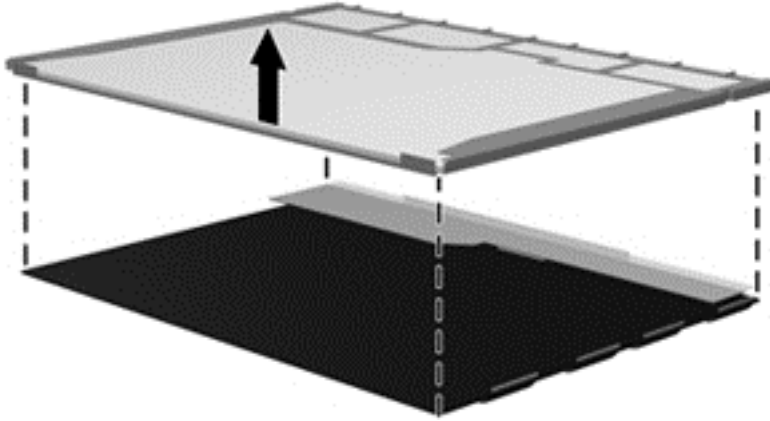

24. Recycle the LCD panel and backlight.

Index

A

- AC adapter, spare part numbers 26, 28
- AC adapter/battery light 14
- antennas
 - disconnecting 47, 49
- audio board
 - spare part number 30
- audio, product description 3
- audio-in (microphone) jack, identifying 15
- audio-out (headphone) jack, identifying 15

B

- backup 114
- Backup and Restore 104
- base enclosure, spare part number 21
- battery
 - spare part number 20, 28, 38
- battery cable
 - removal 74
 - spare part number 74
- battery connector cable, illustrated 24
- BIOS
 - determining version 90, 101
 - downloading an update 91, 102
 - updating 90, 101
- Blu-ray ROM DVD±RW SuperMulti specifications 120
- Blu-ray ROM DVD±RW SuperMulti DL Drive, spare part number 21, 25, 30, 43
- Bluetooth card
 - spare part number 47
- buttons
 - left TouchPad 8
 - optical drive eject 15
 - power 10
 - right TouchPad 8
 - Windows button 12

C

- Cable Kit
 - contents 24
 - spare part number 24
- cables, service considerations 33
- caps lock light, identifying 9
- card reader board
 - removal 66
 - spare part number 19, 30, 66
- card reader cable
 - illustrated 24
- chipset, product description 1
- components
 - display 7
 - front 13
 - left side 14
 - right side 15
 - top 8
- computer reset 107
- Computer Setup
 - navigating and selecting 89, 100
 - restoring factory settings 90, 101
- computer specifications 116
- connector, power 14
- connectors, service considerations 33
- D
 - diskette drive
 - precautions 33
 - display assembly
 - removal 82
 - spare part numbers 82
 - display bezel
 - removal 84
 - spare part numbers 22
 - display cable, illustrated 24
 - display component recycling 129
 - display components, spare part numbers 22
 - display hinge
 - removal 87

- Display Hinge Kit
 - spare part numbers 22
- display panel
 - product description 2
- display rear cover
 - spare part number 23, 28
- display specifications 117
- drives
 - preventing damage 33
- DVD-ROM drive, spare part number 21, 25, 30, 43
- DVD-ROM drive, specifications 120
- DVD±RW SuperMulti DL Drive
 - specifications 119
- DVD±RW SuperMulti DL Drive, spare part number 21, 25, 30, 43

E

- electrostatic discharge 34
- esc key, identifying 12
- Ethernet, product description 3
- external media cards, product description 4
- external monitor port 14

F

- f11 recovery 105
- fan/heat sink assembly
 - spare part number 20, 30, 77
- fingerprint reader assembly
 - removal 62
 - spare part number 19, 28, 62
- fingerprint reader, identifying 11
- fn key, identifying 12
- function board
 - removal 65
 - spare part number 19, 28, 65
- function board cable
 - illustrated 24
- function keys, identifying 12

G

- graphics, product description 2
- grounding equipment and methods 36

- H**
- hard drive
 - precautions 33
 - product description 2
 - removing 40
 - spare part numbers 21, 25, 27, 28, 40
 - specifications 118
- Hard Drive Hardware Kit, spare part number 25, 28
- hard drive light 13
- hard drive recovery 105
- HDMI port, identifying 14
- headphone (audio-out) jack 15
- heat sink
 - removal 77
 - spare part number 20, 30, 77
- hinge
 - removal 87
- I**
- integrated numeric keypad, identifying 12
- integrated webcam light, identifying 7
- internal display switch 7
- internal microphones, identifying 7
- J**
- jacks
 - audio-in (microphone) 15
 - audio-out (headphone) 15
 - network 14
 - RJ-45 (network) 14
- K**
- keyboard
 - product description 4
 - removal 51
 - spare part numbers 19, 28, 51
- keypad
 - integrated numeric 12
- keys
 - esc 12
 - fn 12
 - function 12
- L**
- legacy support, USB 89, 100
- lights
 - AC adapter/battery 14
 - caps lock 9
 - hard drive 13
 - microphone mute 9
 - network 14
 - num lock 9
 - power 9
 - RJ-45 (network) 14
 - webcam 7
 - wireless 9
- M**
- mass storage devices, spare part numbers 25
- Media Card Reader, identifying 13
- memory module
 - product description 2
 - removal 45
 - spare part numbers 21, 45
- microphone
 - spare part number 30
- microphone (audio-in) jack
 - product description 3
- microphone (audio-in) jack, identifying 15
- microphone module
 - spare part number 22
- microphone mute light, identifying 9
- model name 1
- N**
- network jack, identifying 14
- network lights, identifying 14
- num lock light 9
- O**
- operating system, product description 5
- optical drive
 - identifying 15
 - precautions 33
 - product description 3
 - removal 43
 - spare part numbers 21, 25, 43
 - specifications 119, 120
- optical drive eject button, identifying 15
- optical drive extension board
 - removal 72
 - spare part number 20, 30, 72
- optical drive protective insert
 - illustrated 23
- P**
- packing guidelines 35
- PCID label 17
- plastic parts 32
- pointing device, product description 4
- ports
 - external monitor 14
 - HDMI 14
 - product description 4
 - USB 15
- power button board assembly
 - removal 63
 - spare part number 19, 30, 63
- power button board cable
 - illustrated 24
- power button, identifying 10
- power cable
 - removal 72
 - spare part number 72
- power connector cable, illustrated 24
- power connector, identifying 14
- power cord
 - set requirements 127
 - spare part numbers 26, 27
- power lights 9
- power requirements, product description 4
- processor
 - product description 1
 - removal 80
 - spare part numbers 20, 80
- product description
 - audio 3
 - chipset 1
 - display panel 2
 - Ethernet 3
 - external media cards 4
 - graphics 2
 - hard drives 2
 - keyboard 4
 - memory module 2
 - microphone 3
 - operating system 5
 - optical drives 3
 - pointing devices 4

- ports 4
- power requirements 4
- processors 1
- product name 1
- security 5
- serviceability 6
- webcam 3
- wireless 3
- product name 1

R

- recovery 107, 114
- recovery partition 105
- recycle
 - computer 107
- refresh 107
- removal/replacement
 - preliminaries 32
 - procedures, Authorized Service Provider 53
 - procedures, Customer Self-Repair 37
- remove everything and reinstall Windows 107
- reset
 - computer 107
 - steps 107
- restoring the hard drive 105
- RJ-45 (network) jack, identifying 14
- RJ-45 (network) lights, identifying 14
- RTC battery
 - removal 54, 75
 - spare part number 21, 27, 30, 54, 75

S

- Screw Kit, spare part number 26
- security cable slot, identifying 15
- security screw, using 40
- security, product description 5
- service considerations 32
- service door
 - spare part number 21
- service tag 16
- serviceability, product description 6
- setup utility
 - navigating and selecting 89
 - restoring factory settings 90
- Setup Utility (BIOS) 95

- slots
 - security cable 15
- speaker assembly
 - removal 60
 - spare part number 19, 60
- specifications
 - Blu-ray ROM DVD±RW SuperMulti 120
 - computer 116
 - display 117
 - DVD-ROM drive 120
 - DVD±RW SuperMulti DL Drive 119
 - hard drive 118
 - optical drive 119, 120
- static-shielding materials 36
- system board
 - removal 69
 - spare part numbers 19, 69
- System Diagnostics 94, 95

T

- thermal material, replacement 78, 79
- tools required 32
- top cover
 - removal 55
 - spare part number 19, 55
- TouchPad
 - buttons 8
- TouchPad zone
 - identifying 8
- transporting guidelines 35

U

- USB 3.0 port 14
- USB legacy support 89, 100
- USB ports, identifying 14, 15
- USB/audio board
 - removal 68
 - spare part number 20, 68
- USB/audio board cable
 - illustrated 24

V

- vents, identifying 14

W

- webcam 7
 - product description 3
 - spare part number 30

- webcam light, identifying 7
- webcam module
 - removal 86
 - spare part number 22
- webcam, identifying 7
- Windows
 - Refresh 107
 - reinstall 107
 - remove everything and reinstall option 107
 - reset 107
- Windows 8 operating system DVD 106
- Windows button, identifying 12
- wireless antennas
 - disconnecting 47, 49
- wireless antennas, identifying 7
- wireless light 9
- wireless, product description 3
- WLAN antennas
 - spare part number 22, 28
- WLAN antennas, identifying 7
- WLAN/Bluetooth combo card
 - removal 47
 - spare part number 21, 47
- workstation guidelines 35
- WWAN antennas
 - spare part number 23, 28
- WWAN antennas, identifying 7
- WWAN module
 - removal 49
 - spare part number 21, 49