



User Guide

SUMMARY

This guide provides technical specifications and information about monitor features, setting up the monitor, and using the monitor.

Legal information

© Copyright 2022 HP Development Company, L.P.

The terms HDMI, HDMI High-Definition Multimedia Interface, and the HDMI Logo are trademarks or registered trademarks of HDMI Licensing Administrator, Inc. Microsoft and Windows are either registered trademarks or trademarks of Microsoft Corporation in the United States and/or other countries. USB Type-C® is a registered trademark of USB Implementers Forum. DisplayPort™, the DisplayPort™ logo, and VESA are trademarks owned by the Video Electronics Standards Association (VESA) in the United States and other countries.

The information contained herein is subject to change without notice. The only warranties for HP products and services are set forth in the express warranty statements accompanying such products and services. Nothing herein should be construed as constituting an additional warranty. HP shall not be liable for technical or editorial errors or omissions contained herein.

First Edition: June 2022

Part number: N17716-001

Product notice

This guide describes features that are common to most products. Some features may not be available on your computer.

Not all features are available in all editions or versions of Windows. Systems may require upgraded and/or separately purchased hardware, drivers, software or BIOS update to take full advantage of Windows functionality. Windows is automatically updated, which is always enabled. High-speed internet and Microsoft account required. ISP fees may apply and additional requirements may apply over time for updates. See <http://www.microsoft.com>. **If your product ships with Windows in S Mode:** Windows in S Mode works exclusively with apps from the Microsoft Store within Windows. Certain default settings, features, and apps cannot be changed. Some accessories and apps that are compatible with Windows may not work (including some antivirus, PDF writers, driver utilities, and accessibility apps), and performance may vary, even if you switch out of S Mode. If you switch to Windows, you cannot switch back to S Mode. Learn more at [Windows.com/SmodeFAQ](https://www.windows.com/SmodeFAQ).

To access the latest user guides, go to <http://www.hp.com/support>, and follow the instructions to find your product. Then select **Manuals**.





Software terms

By installing, copying, downloading, or otherwise using any software product preinstalled on this computer, you agree to be bound by the terms of the HP End User License Agreement (EULA). If you do not accept these license terms, your sole remedy is to return the entire unused product (hardware and software) within 14 days for a full refund subject to the refund policy of your seller.

For any further information or to request a full refund of the price of the computer, please contact your seller.

About this guide

This guide provides technical specifications and information about monitor features, setting up the monitor, and using the software. Depending on the model, your monitor may not have all the features included in this guide.

-
-  **WARNING!** Indicates a hazardous situation that, if not avoided, **could** result in serious injury or death.
 -  **CAUTION:** Indicates a hazardous situation that, if not avoided, **could** result in minor or moderate injury.
 -  **IMPORTANT:** Indicates information considered important but not hazard-related (for example, messages related to property damage). Warns the user that failure to follow a procedure exactly as described could result in loss of data or in damage to hardware or software. Also contains essential information to explain a concept or to complete a task.
 -  **NOTE:** Contains additional information to emphasize or supplement important points of the main text.
 -  **TIP:** Provides helpful hints for completing a task.
-



This product incorporates HDMI technology.

Table of contents

1 Getting started	1
Important safety information	1
More HP resources	1
Preparing to call technical support	2
Getting to know your monitor	2
Features	2
Front components	3
Rear components	4
Setting up the monitor	7
Attaching the monitor stand to a curved screen monitor	7
Attaching the monitor stand to a flat screen monitor	8
Attaching the monitor stand to the 80 cm (31.5 in) flat screen monitor	9
Mounting the monitor head	10
Removing the monitor stand	11
Attaching the monitor head to a mounting device	11
Connecting the cables	12
Adjusting the monitor (select products only)	15
Installing a security cable	16
Turning on the monitor	16
HP watermark and image retention policy	17
2 Using the monitor	18
Downloading software and utilities	18
Downloading HP Display Center	18
The Information file	18
The Image Color Matching file	18
Using the OSD menu	19
Using the joypad OSD buttons	19
Reassigning the OSD menu options	20
Display mode status	20
Changing the Power Mode setting (select products only)	20
Using Auto-Sleep Mode	21
Using low blue light mode (select products only)	21
Adjusting blue light output (select products only)	21
3 Support and troubleshooting	23
Using the self-test function	23
Using internal diagnostics	23

Solving common issues	24
Button lockouts	25
Optimizing image performance (VGA input)	25
4 Maintaining the monitor	27
Maintenance guidelines.....	27
Cleaning the monitor	27
Shipping the monitor.....	28
Appendix A Technical specifications	29
80.01 cm (31.5 in) model specifications	29
68.58 cm (27 in) model specifications (fixed stand)	29
68.58 cm (27 in) model specifications (height-adjustable stand).....	30
68.58 cm (27 in) model specifications (curved)	31
60.45 cm (23.8 in) model specifications (fixed stand).....	31
60.45 cm (23.8 in) model specifications (height-adjustable stand).....	32
60.45 cm (23.8 in) model specifications (VA model)	33
54.61 cm (21.5 in) model specifications	33
54.61 cm (21.5 in) model specifications (height-adjustable stand).....	34
54.48 cm (21.45 in) model specifications	35
Preset display resolutions	35
80.01 cm (31.5 in) model	36
68.58 cm (27 in) model.....	37
68.58 cm (27 in) curved model.....	37
60.45 cm (23.8 in) model	38
54.61 cm (21.5 in) models.....	39
54.48 cm (21.45 in) models	40
High-definition video formats	41
Energy saver feature	42
Appendix B Accessibility	43
HP and accessibility	43
Finding the technology tools you need.....	43
The HP commitment.....	43
International Association of Accessibility Professionals (IAAP)	44
Finding the best assistive technology.....	44
Assessing your needs	44
Accessibility for HP products.....	44
Standards and legislation.....	45
Standards.....	45
Mandate 376 – EN 301 549	45
Web Content Accessibility Guidelines (WCAG).....	45
Legislation and regulations.....	45
Useful accessibility resources and links	46

Organizations	46
Educational institutions	46
Other disability resources	46
HP links	47
Contacting support	47
Index	48

1 Getting started

Read this chapter to learn about safety information and where to find additional HP resources.

Important safety information

A power cord might be included with the monitor. If you use another cord, use only a power source and connection appropriate for this monitor. For information about the correct power cord set to use with the monitor, see the *Product Notices* provided in your documentation kit.

 **WARNING!** To reduce the risk of electric shock or damage to the equipment:

- Plug the power cord into an AC outlet that is easily accessible at all times.
- If the power cord has a three-pin attachment plug, plug the cord into a grounded (earthed) three-pin outlet.
- Disconnect power from the computer by unplugging the power cord from the AC outlet. When unplugging the power cord from the AC outlet, grasp the cord by the plug.

For your safety, do not place anything on power cords or cables. Take care to route all cords and cables connected to the monitor so that they cannot be stepped on, pulled, grabbed, or tripped over.

To reduce the risk of serious injury, read the *Safety & Comfort Guide* provided with your user guides. It describes proper workstation setup and proper posture, health, and work habits for computer users. The *Safety & Comfort Guide* also provides important electrical and mechanical safety information. The *Safety & Comfort Guide* is also available on the web at <http://www.hp.com/ergo>.

 **IMPORTANT:** For the protection of the monitor and the computer, connect all power cords for the computer and its peripheral devices (such as a monitor, printer, scanner) to a surge protection device such as a power strip or uninterruptible power supply (UPS). Not all power strips provide surge protection; the power strip must be specifically labeled as having this capability. Use a power strip whose manufacturer offers a damage replacement policy so that you can replace the equipment if surge protection fails.

Use the appropriate and correctly sized furniture designed to properly support your monitor.

 **WARNING!** Monitors that are inappropriately situated on dressers, bookcases, shelves, desks, speakers, chests, or carts could fall over and cause personal injury.

 **WARNING! Stability hazard:** The device might fall, causing serious personal injury or death. To prevent injury, securely attach the monitor to the floor or wall in accordance with the installation instructions.

 **WARNING!** This equipment is not suitable for use in locations where children are likely to be present.

 **NOTE:** This product is suitable for entertainment purposes. Consider placing the monitor in a controlled luminous environment to avoid interference from surrounding light and bright surfaces that might cause disturbing reflections from the screen.

More HP resources

Use this table to locate resources that provide product details, how-to information, and more.

Table 1-1 Additional information

Resource	Contents
Setup Instructions	Overview of monitor setup and features
HP support	For HP support or to resolve a hardware or software problem, go to http://www.hp.com/support , and follow the instructions to find your product. – or – Select the Search icon in the taskbar, type <code>support</code> in the search box, and then select HP Support Assistant . – or – Select the question mark icon in the taskbar.

NOTE: Contact customer support to replace the power cord or any other cables that shipped with your monitor.

Preparing to call technical support

Use this information if you have to troubleshoot an issue.

If you cannot solve a problem using [Support and troubleshooting on page 23](#), a call to technical support can provide additional help. Have the following information available when you call:

- Monitor model number
- Monitor serial number
- Purchase date on invoice
- Conditions under which the problem occurred
- Error messages received
- Hardware configuration
- Name and version of the hardware and software that you are using

Getting to know your monitor

Your monitor has top-rated features. This section provides details about your components, where they are located, and how they work.

Features

Depending on the model, your monitor might include the following features:

Display features

- 54.61 cm (21.5 in), 54.48 cm (21.45 in), 60.45 cm (23.8 in), or 68.58 cm (27 in), plus full-screen support for lower resolutions; includes custom scaling for maximum image size while preserving original aspect ratio
- 80 cm (31.5 in) diagonal viewable screen area with 2560 × 1440 resolution
- Liquid crystal display (LCD) with active matrix and in-plane switching (IPS) (select products only)

- Liquid crystal display (LCD) with active matrix and vertical alignment (VA) (select products only)
- sRGB color gamut
- Nonglare panel with an LED backlight
- Tilt capabilities
- Height adjustment capabilities (select products only)
- On-screen display (OSD) adjustments in several languages for easy setup and screen optimization
- Energy saver feature to meet requirements for reduced power consumption
- Security cable slot on the rear of the monitor for an optional security cable
- Cable management feature for placement of cables and cords
- Speakers are available on select models only

Connectors

- VGA port (select products only)
- DisplayPort™ video input (select products only)
- High-Definition Multimedia Interface™ (HDMI™) video input
- USB Type-C® port (select products only)
- Plug and Play capability, if supported by your operating system

Monitor stand

- Removable stand for flexible monitor head mounting solutions
- VESA® mounting capability (100 × 100 mm) for attaching the monitor to a swing arm mount
- Support for a mounting bracket to attach the monitor to a workstation



NOTE: For safety and regulatory information, see the *Product Notices* provided in your documentation kit. To access the latest user guide, go to <http://www.hp.com/support>, and follow the instructions to find your product. Then select **Manuals**.

Front components

To identify the components on the front of the monitor, use this illustration and table.

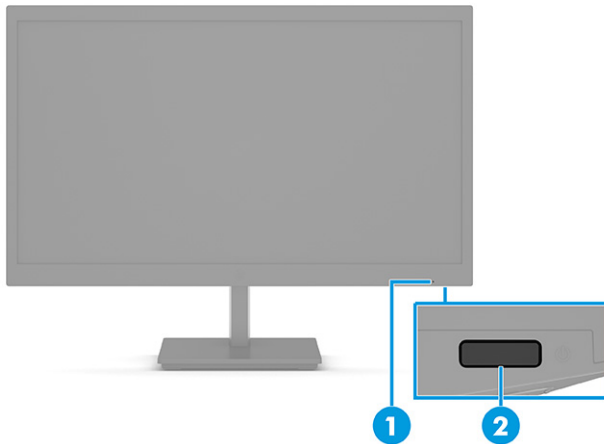

Table 1-2 Front components and their description

Component	Description
(1) Power LED	Indicates that the monitor is powered on.
(2) Power button	Turns the monitor on or off.

NOTE: Be sure that the master power switch on the monitor is in the On position to turn on the monitor. (Select products only.)

Rear components

To identify the components on the rear of the monitor, use these illustrations and tables.

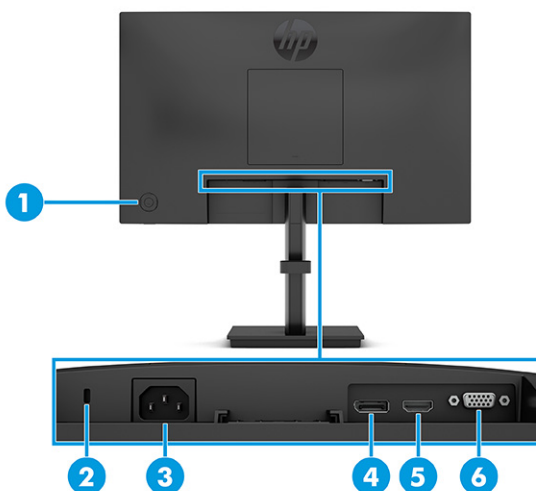

Table 1-3 Rear components and their descriptions (21.5 in, 23.8 in, and 27 in IPS models)

Component	Description
(1) Joypad OSD button	Opens the OSD settings.
(2) Security cable slot	Connects an optional security cable.

Table 1-3 Rear components and their descriptions (21.5 in, 23.8 in, and 27 in IPS models) (continued)

Component	Description
(3) Power connector	Connects a power cord.
(4) DisplayPort connector	Connects a DisplayPort cable to a source device such as a computer or game console.
(5) HDMI port	Connects the HDMI cable to a source device such as a computer or game console.
(6) VGA port	Connects a VGA cable to a source device such as a computer or game console.



Table 1-4 Rear components and their descriptions (21.45 in and 23.8 in VA models)

Component	Description
(1) Joypad OSD button	Opens the OSD settings.
(2) Security cable slot	Connects an optional security cable.
(3) Power connector	Connects a power cord.
(4) HDMI port	Connects the HDMI cable to a source device such as a computer or game console.
(5) VGA port	Connects a VGA cable to a source device such as a computer or game console.

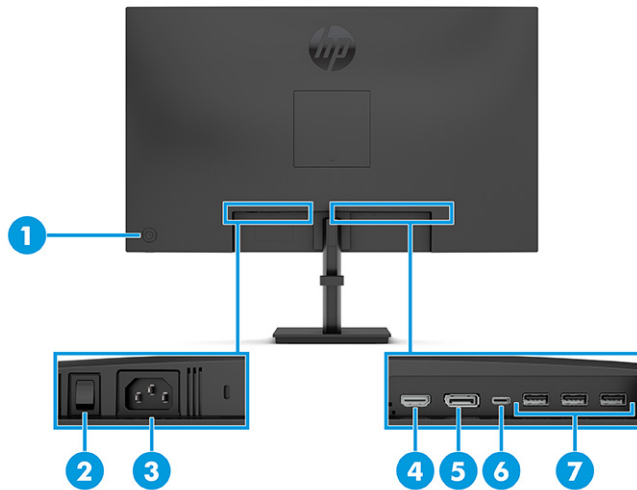

Table 1-5 Rear components and their descriptions (31.5 in model)

Component	Description
(1) Joypad OSD button	Opens the OSD settings.
(2) Master power switch	Turns the monitor on or off.
(3) Power connector	Connects a power cord.
(4) HDMI port	Connects the HDMI cable to a source device such as a computer or game console.
(5) DisplayPort connector	Connects a DisplayPort cable to a source device such as a computer or game console.
(6) USB Type-C port	Connects a USB Type-C cable to a source device such as a computer or game console. NOTE: This port can function as a DisplayPort audio/video input or as a USB 3.0 connection. It can also be used to deliver up to 65 W of power to a device.
(7) USB ports (3)	Connects a USB cable to a source device such as a computer or game console. NOTE: You can connect a USB Type-C cable between the source device and monitor to enable USB ports on the monitor.

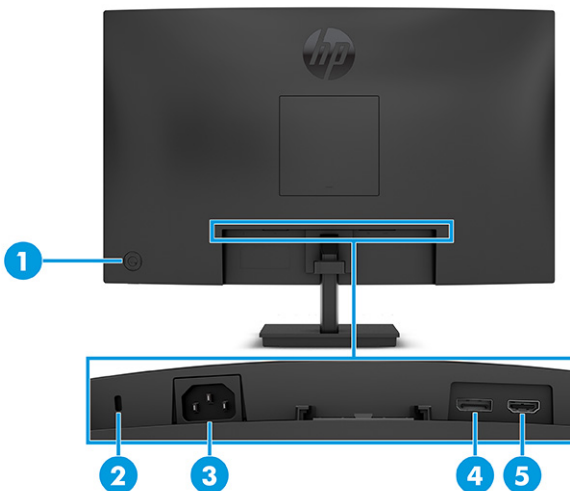



Table 1-6 Rear components and their descriptions (27 in curved model)

Component	Description
(1) Joypad OSD button	Opens the OSD settings.
(2) Security cable slot	Connects an optional security cable.
(3) Power connector	Connects a power cord.
(4) DisplayPort connector	Connects a DisplayPort cable to a source device such as a computer or game console.
(5) HDMI port	Connects the HDMI cable to a source device such as a computer or game console.

Setting up the monitor

This section describes attaching the monitor stand or wall mount and the options for connecting your monitor to a PC, notebook, gaming console, or similar device.

 **WARNING!** To reduce the risk of serious injury, read the *Safety & Comfort Guide*. It describes proper workstation setup and proper posture, health, and work habits for computer users. The *Safety & Comfort Guide* also provides important electrical and mechanical safety information. The *Safety & Comfort Guide* is available on the web at <http://www.hp.com/ergo>.

 **IMPORTANT:** To prevent damage to the monitor, do not touch the surface of the LCD panel. Pressure on the panel can cause nonuniformity of color or disorientation of the liquid crystals. If this occurs, the screen will not recover to its normal condition.

 **IMPORTANT:** To prevent the screen from getting scratched, defaced, or broken and to prevent damage to the control buttons, position the monitor facedown on a flat surface covered with protective sheet foam or a nonabrasive cloth.

Attaching the monitor stand to a curved screen monitor

Correctly attaching your monitor stand is critical for safe use. This section describes how to safely attach a stand.

 **TIP:** Consider the placement of the monitor, because surrounding light and bright surfaces might cause interfering reflections.

 **NOTE:** The procedures for attaching a monitor stand might be different on other models.

1. Leave the monitor in the shipping box to protect the screen.
2. Position the monitor stand on the mounting plate on the rear of the monitor **(1)**.

3. Slide the monitor stand into the mounting plate (2).

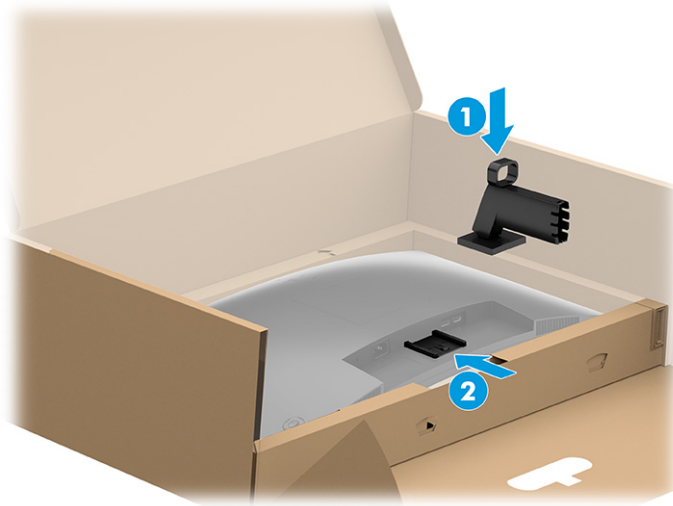

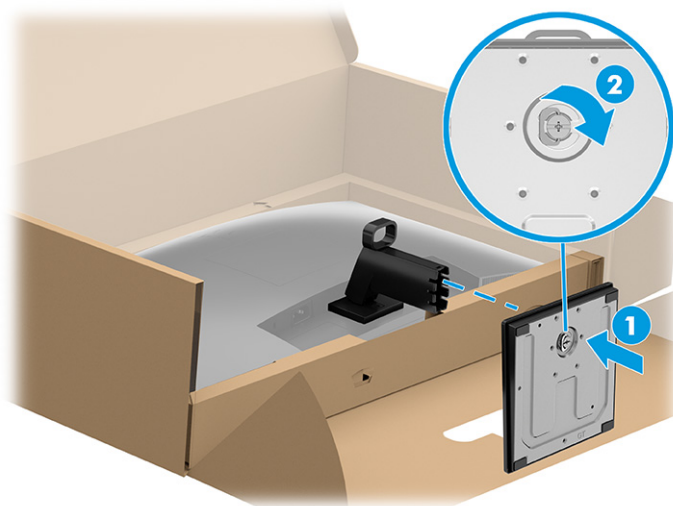

4. Attach the base to the monitor stand (1) and tighten the screw (2).



Attaching the monitor stand to a flat screen monitor

Correctly attaching your monitor stand is critical for safe use. This section describes how to safely attach a stand.

 **TIP:** Consider the placement of the monitor, because surrounding light and bright surfaces might cause interfering reflections.

 **NOTE:** The procedures for attaching a monitor stand might be different on other models.

1. Position the monitor head facedown on a flat surface covered by a protective sheet made of foam or a clean, dry cloth.

2. Position the monitor stand on the mounting plate on the rear of the monitor (1), and then slide the monitor stand into the mounting plate (2).

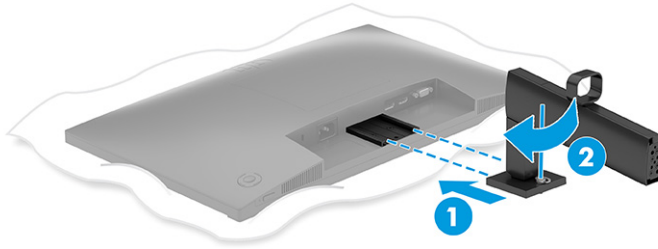

3. Do one of the following, depending on the type of base you are installing.
 - Attach the base to the monitor stand (1), and then tighten the screws (2).

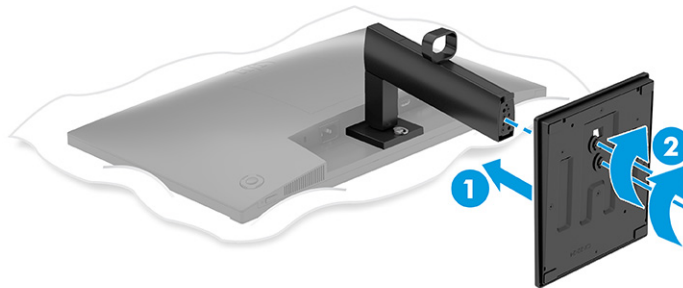

- Attach the base to the monitor stand, and then snap the base onto the stand.

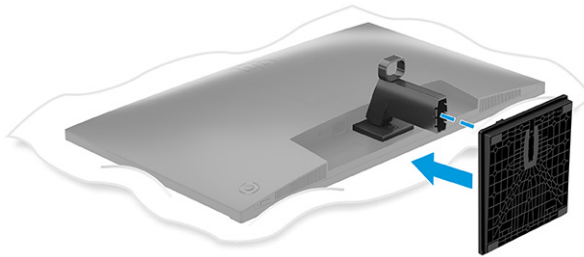

Attaching the monitor stand to the 80 cm (31.5 in) flat screen monitor

Correctly attaching your monitor stand is critical for safe use. This section describes how to safely attach a stand.

 **TIP:** Consider the placement of the monitor, because surrounding light and bright surfaces might cause interfering reflections.

 **NOTE:** The procedures for attaching a monitor stand might be different on other models.

1. Leave the monitor in the shipping box to protect the screen.

2. Position the monitor stand on the mounting plate on the rear of the monitor (1), and then tighten the screw on the monitor stand into the mounting plate (2).

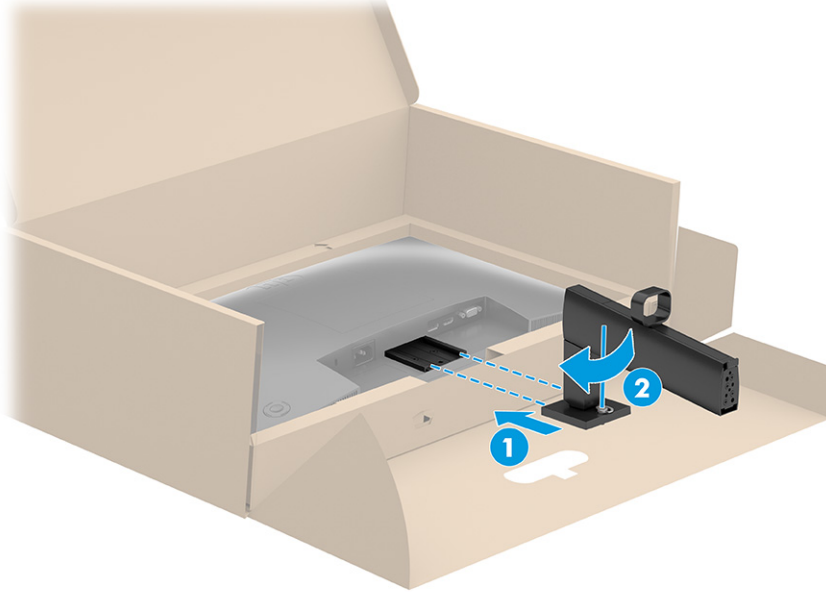

3. Attach the base to the monitor stand (1), and then tighten the screws (2).



NOTE: The base for your monitor may appear different than the one pictured.

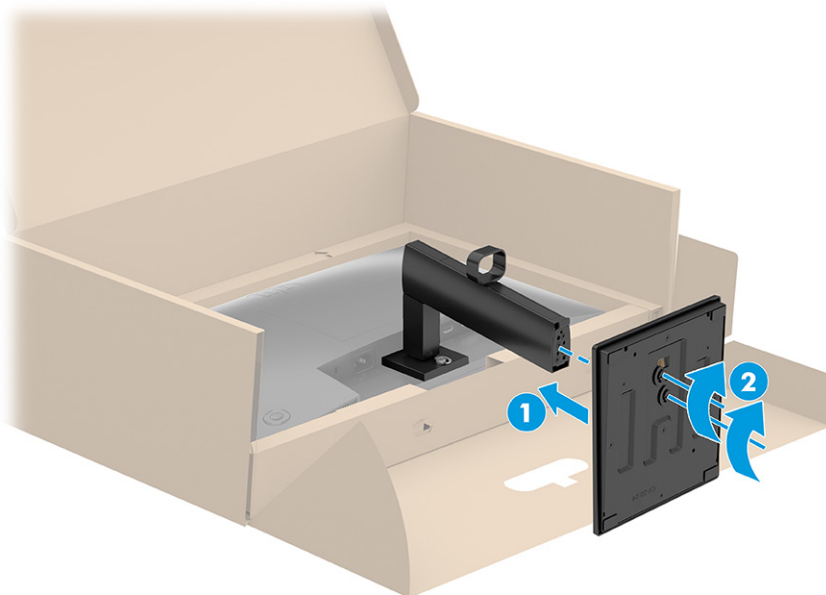

Mounting the monitor head

To attach your monitor to a wall using a swing arm or other mounting fixture, follow the steps in this section to safely and securely connect your monitor.



IMPORTANT: This monitor supports the VESA industry-standard 100 mm mounting holes. To attach a third-party mounting solution to the monitor head, use four 4 mm, 0.7 pitch, and 10 mm long screws (M4 x 10L).

Longer screws might damage the monitor. Be sure that the manufacturer's mounting solution is compliant with the VESA standard and is rated to support the weight of the monitor head. For best performance, use the power and video cables provided with the monitor.

 **NOTE:** This apparatus is intended to be supported by a UL-listed or CSA-listed wall-mount bracket.

Removing the monitor stand

If you decide to use a wall mount instead of the monitor stand that you attached, first remove the stand.

 **IMPORTANT:** Before you disassemble the monitor, be sure that the monitor is turned off and all cables are disconnected.

 **IMPORTANT:** To position and stabilize the monitor, HP recommends that two people perform these procedures.

1. Disconnect and remove all cables from the monitor.
2. Position the monitor facedown on a flat surface covered by protective sheet made of foam or a clean, dry cloth.
3. Push up the latch or screw near the bottom center of the stand's mounting plate (1).
4. Swing the bottom of the stand up until the mounting plate clears the recess in the monitor head (2).
5. Slide the stand out of the recess.

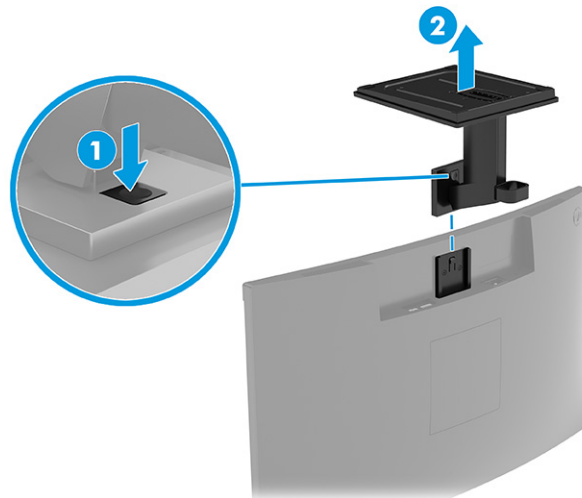

Attaching the monitor head to a mounting device

You might need additional tools such as a screwdriver (purchased separately) when you attach a mounting device. To avoid damage to your monitor, follow these instructions.

1. Press the latch (1), and then lift up the cover (2) to remove the VESA cover from the rear of the monitor.

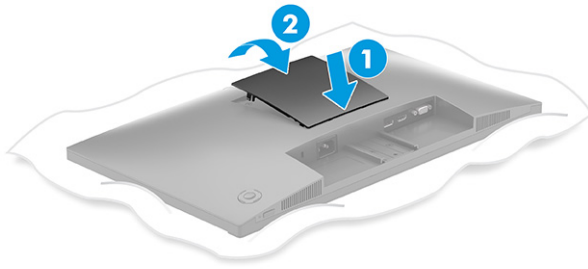

2. Remove the four screws from the VESA holes located on the rear of the monitor head.

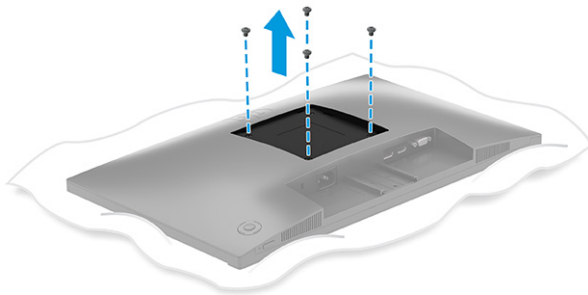

3. To attach the monitor head to a swing arm or other mounting device, insert four mounting screws through the holes on the mounting device and into the VESA screw holes on the back of the monitor head.



IMPORTANT: If these instructions do not apply to your device, follow the mounting device manufacturer's instructions when mounting the monitor to a wall or swing arm.

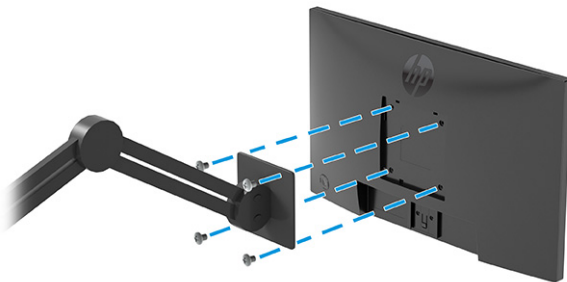

Connecting the cables

In addition to details about how to connect a cable, this section contains information about how your monitor functions when you connect certain cables.

 **NOTE:** Depending on the model, the monitor might be capable of supporting VGA, USB Type-C, HDMI, or DisplayPort inputs. The video mode is determined by the video cable used. The monitor automatically determines which inputs have valid video signals. You can select the inputs through the OSD menu. The monitor ships with select cables. Not all cables shown in this section are included with the monitor.

1. Place the monitor in a convenient, well-ventilated location near the computer.
2. Connect a video cable.

 **NOTE:** The monitor automatically determines which inputs have valid video signals. To select any input, open the OSD menu and select **Input**.

- Connect one end of a VGA cable to the VGA port on the rear of the monitor and the other end to the VGA port on the source device.

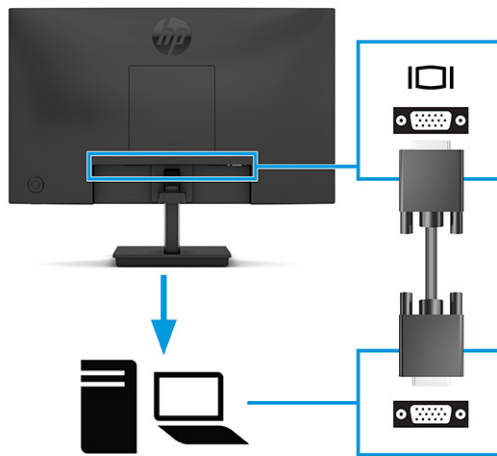

- Connect one end of a DisplayPort cable to the DisplayPort connector on the rear of the monitor and the other end to the DisplayPort connector on the source device.

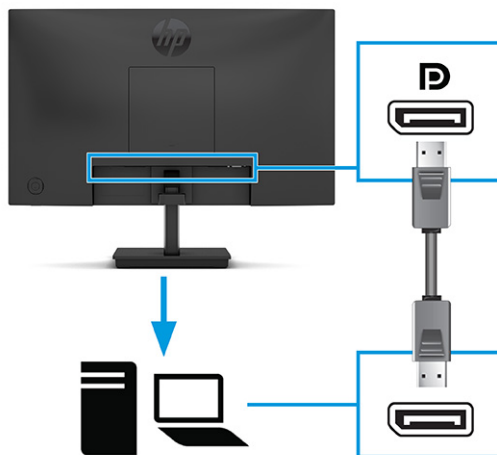

- Connect one end of an HDMI cable to the HDMI port on the rear of the monitor and the other end to the HDMI port on the source device.

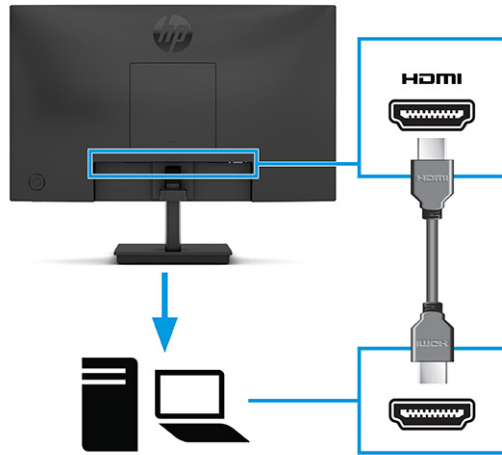

3. Connect one end of a USB Type-C cable to the USB Type-C port on the rear of the monitor and the other end to the USB Type-C port on the source device.

 **NOTE:** The monitor's USB Type-C port provides data, video, and power delivery (up to 65 W). The host device must be able to support DisplayPort Alt Mode (video, charging, and USB) over the USB Type-C connector.

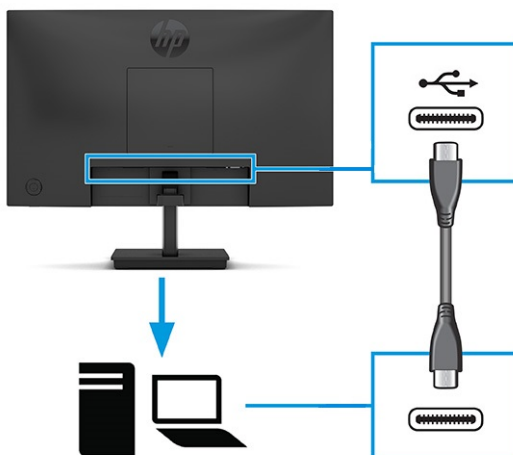

4. Connect one end of the power cord to the power connector on the monitor and the other end to a grounded AC outlet.

 **WARNING!** To reduce the risk of electric shock or damage to the equipment:

Do not disable the power cord grounding plug. The grounding plug is an important safety feature.

Plug the power cord into a grounded (earthed) AC outlet that is easily accessible at all times.

Disconnect power from the equipment by unplugging the power cord from the AC outlet.

For your safety, do not place anything on power cords or cables. Arrange them so that no one can accidentally step on or trip over them. Do not pull on a cord or cable. When unplugging the power cord from the AC outlet, grasp the cord by the plug.

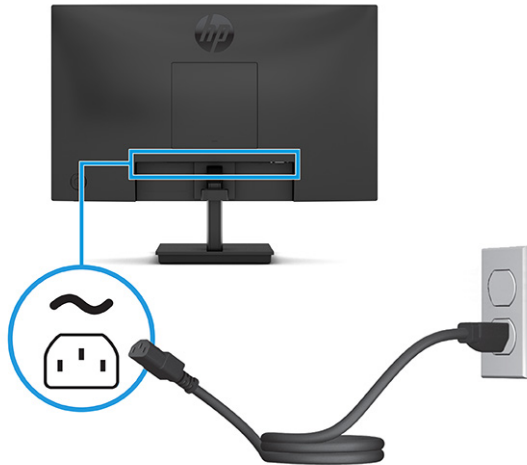

Adjusting the monitor (select products only)

To support an ergonomic work space, your monitor offers the adjustment options outlined in this section.

⚠ WARNING! To reduce the risk of serious injury, read the *Safety & Comfort Guide*. It describes proper workstation setup and proper posture, health, and work habits for computer users. The *Safety & Comfort Guide* also provides important electrical and mechanical safety information. The *Safety & Comfort Guide* is available on the web at <http://www.hp.com/ergo>.

1. Tilt the monitor head forward or backward to set it to a comfortable eye level.



2. Adjust the monitor's height to a comfortable position for your individual workstation. The monitor's top bezel edge should not exceed a height that is parallel to your eye height. A monitor that is positioned low

and reclined might be more comfortable for users with corrective lenses. Reposition your monitor as you adjust your working posture throughout the work day.

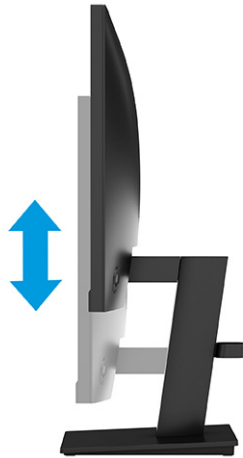

Installing a security cable

As a security measure, you can secure the monitor to a fixed object with an optional security cable available from HP. Use the key that came with the optional security cable to attach and remove the lock.

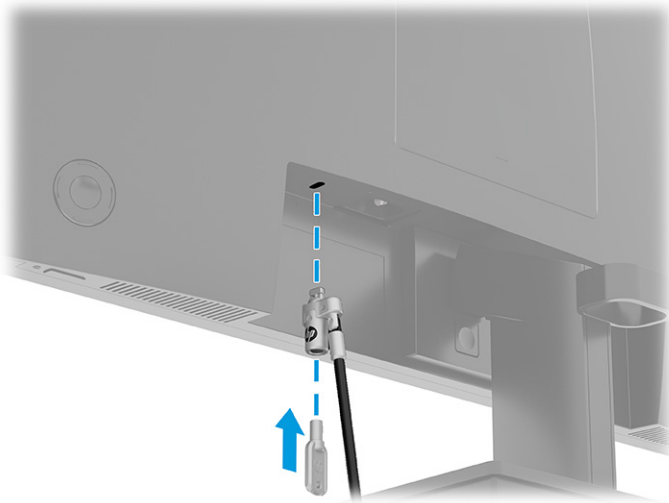

Turning on the monitor

This section provides important information about preventing damage to your monitor, startup indicators, and troubleshooting information.

 **IMPORTANT:** Burn-in image damage might occur on monitors that display the same static image on the screen for 12 or more hours. To avoid burn-in image damage, you should always activate a screen saver application or turn off the monitor when it will not be in use for a prolonged period of time. Image retention is a condition that might occur on all LCD screens. Burn-in damage on the monitor is not covered under the HP warranty.

- Press the power button on the monitor to turn it on.



 **NOTE:** If pressing the power button has no effect, the Power Button Lockout feature might be enabled. To disable this feature, press and hold the monitor power button for 10 seconds.

When you first turn on your monitor, a monitor status message is displayed for 5 seconds. The message shows which input is the current active signal, the status of the auto-switch source setting (On or Off; default setting is On), the current preset display resolution, and the recommended preset display resolution.

The monitor automatically scans the signal inputs for an active input and uses that input for the display.

HP watermark and image retention policy

Some monitors are designed with In-Plane Switching (IPS) and Vertical Alignment (VA) display technology, which provides ultrawide viewing angles and advanced image quality. Though suitable for many applications, this panel technology is not suitable for static, stationary, or fixed images for long periods of time, unless you use screen savers.

Applications with static images can include camera surveillance, video games, marketing logos, and templates. Static images can cause image retention damage that could look like stains or watermarks on the monitor's screen.

Image retention damage on monitors that are in use 24 hours per day is not covered under the HP warranty. To avoid image retention damage, always turn off the monitor when it is not in use, or use the power management setting, if supported on your computer, to turn off the monitor when the computer is idle.

2 Using the monitor

This chapter describes how to use your monitor and its features, including software and utilities, the OSD menu, the function buttons, power modes, and Windows Hello.

Downloading software and utilities

You can download and install these files from HP Support.

- INF (Information) file
- ICM (Image Color Matching) files

To download the files:

1. Go to <http://www.hp.com/support>.
2. Select **Software and Drivers**.
3. Select your product type.
4. Enter your HP monitor model in the search field and follow the on-screen instructions.

Downloading HP Display Center

You can download and install the HP Display Center software from the Microsoft store.

1. Select the Microsoft Store app on your desktop or enter `Microsoft Store` in the taskbar search box.
2. Enter `HP Display Center` in the **Microsoft Store** search box.
3. Follow the on-screen instructions.

The tool downloads to the selected location.

The Information file

The INF file defines monitor resources used by Windows® operating systems to ensure monitor compatibility with the computer's graphics adapter.

This monitor is Plug and Play compatible, and the monitor will work correctly without installing the INF file. Monitor Plug and Play compatibility requires that the computer's graphics card is VESA DDC2 compliant and that the monitor connects directly to the graphics card. Plug and Play does not work through separate BNC-type connectors or through distribution buffers, boxes, or both.

The Image Color Matching file

The ICM files are data files that are used in conjunction with graphics programs to provide consistent color matching from monitor screen to printer, or from scanner to monitor screen. These files are activated from within graphics programs that support this feature.



NOTE: The ICM color profile is written in accordance with the International Color Consortium (ICC) Profile Format specification.

Using the OSD menu

You can adjust your HP monitor to suit your preferences. Use the OSD menu to customize the viewing features of your monitor.

To access and make adjustments in the OSD, use the joypad OSD button on the monitor's rear panel:

1. If the monitor is not already on, press the power button to turn on the monitor.
2. Press the **Menu** button or, if you are using the joypad OSD button, press the center of the joypad OSD button.
3. Press the function buttons up, down, left, or right to navigate menu choices. Press the center of the joypad OSD button to make a selection.

The following table lists possible menu selections in the OSD main menu. It includes descriptions for each setting and its impacts on your monitor's appearance or performance.

Table 2-1 OSD menu options and descriptions for using a button or a controller (select products only)

Main menu	Description
Brightness	Adjusts the brightness level of the screen.
Color	Selects and adjusts the screen color.
Input	Selects the video input signal (DisplayPort or HDMI).
Image	Adjusts the screen image.
Power	Adjusts the power settings.
Menu	Adjusts the OSD menu and function button controls, and selects the language in which the OSD menu is displayed (the factory default is English).
Management	Adjusts the DDC/CI settings, and returns all OSD menu settings to the factory default settings.
Information	Opens the Information menu.
Exit	Exits the OSD menu screen.

Using the joypad OSD buttons

The menu options offer useful actions, and you can customize all except one of the options to make them even more useful.



NOTE: The actions of the menu options vary among monitor models.

For information about changing the function of the menu options, see [Reassigning the OSD menu options on page 20](#).

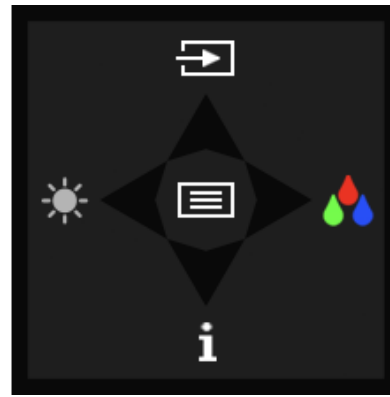
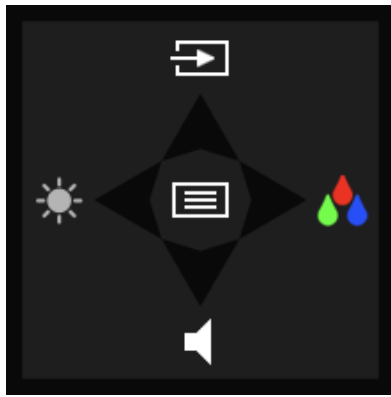

Table 2-2 Menu options and functions

Option	Icon	Description
Menu		Opens the OSD main menu, selects a menu item from the OSD, or closes the OSD menu.
Brightness		Adjusts the monitor screen brightness.
Color		Opens the Color menu where you can select a preset view mode.
Information		Opens the Information menu.
Next		Switches the monitor's input source to the next active input.
Volume		Opens the Volume menu.

Reassigning the OSD menu options

Except for the **Menu** option, you can change the action associated with an option from its default action to a menu option you use more frequently.

To reassign the function buttons:

1. Press the [Menu](#) option to open the OSD menu.
2. Select **Menu**, select **Assign Buttons**, and then select one of the available options for the button that you want to assign.

Display mode status

When you turn on the monitor, the status message shows the display mode. The display mode is also displayed when you change the video input.

Changing the Power Mode setting (select products only)

This section describes how to activate Performance mode. Certain features on your monitor might require Performance mode to be active.

When in sleep mode, to comply with international power standards, the monitor default setting is Power Saver mode.

If your monitor supports Performance mode, to keep the USB ports enabled when the monitor is in Auto-Sleep Mode, change the Power Mode setting from **Power Saver** to **Performance**.



NOTE: If you are connecting a computer that is not battery powered, you must change the Power Mode setting to Performance mode.

To change the power mode setting:

1. Press the **Menu** button to open the OSD menu.
2. Select **Power**, select **Power Mode**, and then select **Performance**.
3. Select **Back** and close the OSD.

Using Auto-Sleep Mode

Your monitor has an energy-saving feature called Auto-Sleep Mode, a reduced power state. This section describes how to activate or adjust Auto-Sleep Mode on your monitor.

When Auto-Sleep Mode is enabled (enabled by default), the monitor enters a reduced power state when the computer signals low power mode (absence of either horizontal or vertical sync signal).

Upon entering this reduced power state (Auto-Sleep mode), the monitor screen is blanked, the backlight turns off, and the power light turns amber. The monitor draws less than 0.5 W of power when in this reduced power state. The monitor wakes from Auto-Sleep mode when the computer sends an active signal to the monitor (for example, when you activate the mouse or keyboard).

To disable Auto-Sleep Mode in the OSD:

1. Press the **Menu** button to open the OSD, or press the center of the joypad OSD button to open the OSD.
2. In the OSD, select **Power**.
3. Select **Auto-Sleep Mode**, and then select **Off**.

Using low blue light mode (select products only)

Decreasing the blue light emitted by the monitor reduces the blue light exposure to your eyes.

When the low blue light mode is enabled, this monitor's low blue light panel is certified by TÜV to reduce blue light output and create a more relaxing and less stimulating image while you read content on the screen.

Adjusting blue light output (select products only)

Decreasing the blue light emitted by the monitor reduces the blue light exposure to your eyes. This monitor allows you to select a setting to reduce blue light output and create a more relaxing and less stimulating image while you read content on the screen.

To adjust the blue light output from the monitor:

1. Press one of the OSD buttons to activate the buttons, and then press the **Menu** button to open the OSD. Select **Color**.

If you are using a controller, press the center of the joypad OSD button to open the OSD.

2. Select **Low Blue Light** from the setting options.
 - **Low Blue Light:** (TÜV certified) Reduces blue light for improved eye comfort.
 - **Reading:** Optimizes blue light and brightness for indoor viewing.
 - **Night:** Adjusts to the lowest blue light and reduces the impact on sleep.
3. Select **Save and Return** to save your setting and close the menu. Select **Cancel** if you do not want to save the setting.
4. In the Main menu, select **Exit**.

3 Support and troubleshooting

If your monitor is not working as expected, you might be able to resolve the issue by following the instructions in this section.

Using the self-test function

The following procedure describes how to use the self-test function to diagnose possible issues with the monitor.

1. Turn off the monitor and disconnect all of the cables except the power cord.
2. Turn on the monitor. The following screens display to show that the monitor is working as expected and is looking for a valid video signal.

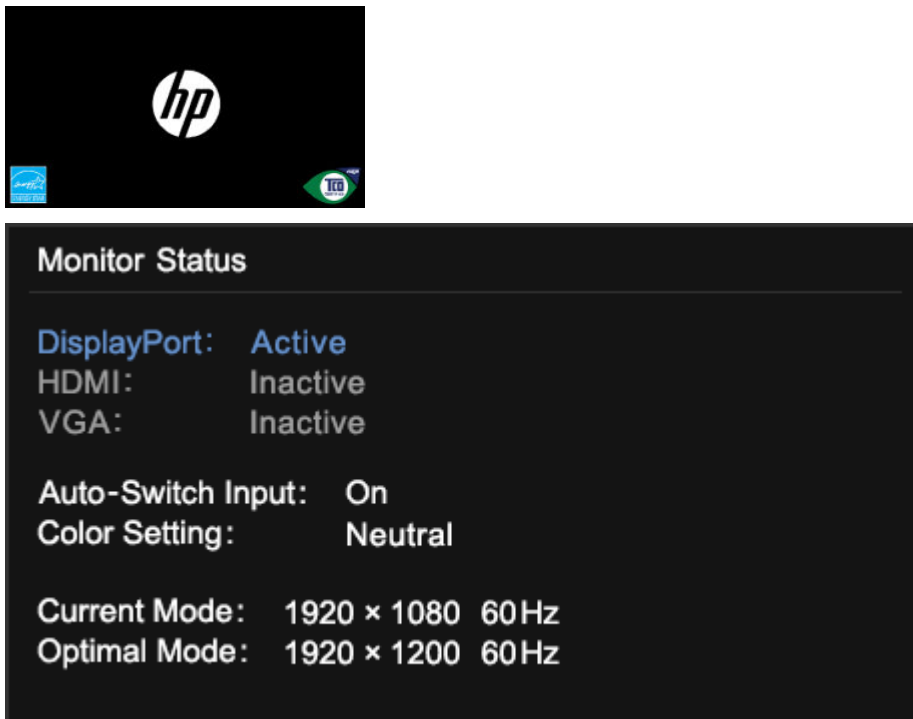

If the video remains blank, verify the computer's video signal.

Using internal diagnostics

The following procedure describes how to use the internal diagnostics to diagnose possible issues with the monitor.

1. Turn off the monitor and disconnect all cables except the power cord.
2. Press and hold the OSD button, and then turn on the monitor.

3. Release the OSD button. The following test pattern menu displays.

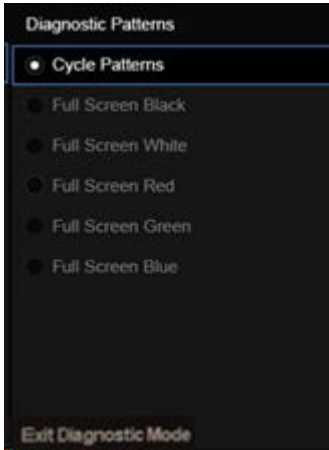

4. To exit the Test Pattern menu, select **Exit Diagnostic Mode**, turn off the monitor, or connect the signal cable.

Solving common issues

The following table lists possible issues, the possible cause of each issue, and the recommended solutions.

 **NOTE:** Always ensure that the BIOS, device firmware, and monitor firmware are updated to the latest version.

 **NOTE:** When connecting a computer that supports Power Delivery over a USB Type-C, it is recommended to set the Power mode to **Performance** to provide power support when the monitor is in the Sleep or Off mode.

Table 3-1 Common issues and solutions

Issues	Possible cause	Solution
Screen is blank or video is blinking.	Power cord is disconnected.	Connect the power cord.
	Monitor is off.	Press the monitor power button. NOTE: If pressing the power button has no effect, press and hold the power button for 10 sec to disable the Power Button Lockout feature.
	Master power switch is set to off.	Set the master power switch on the rear of the monitor to the On position.
	Video cable is improperly connected.	Connect the video cable properly. For more information, see Connecting the cables on page 12 .
	System is in Auto-Sleep Mode.	Press any key on the keyboard or move the mouse to inactivate the screen blanking utility.
	Video card is incompatible.	Open the OSD menu and select the Input menu. Set Auto-Switch Input to Off and manually select the input. or Replace the video card or connect the video cable to one of the computer's on-board video sources.
Image appears blurred, indistinct, or too dark.	Brightness setting is too low.	Open the OSD menu, and select Brightness to adjust the brightness scale as needed.

Table 3-1 Common issues and solutions (continued)

Issues	Possible cause	Solution
“Check Video Cable” is displayed on the screen.	Monitor video cable is disconnected.	Connect the appropriate video signal cable between the computer and monitor. Be sure that the computer power is off while connecting the video cable.
“Input Signal Out of Range” is displayed on screen.	Video resolution rate, refresh rate, or both, are set higher than the monitor supports.	Change the settings to a supported setting. See Preset display resolutions on page 35 .
The monitor does not enter into a low-power sleep state.	The monitor's power saving control is disabled.	Open the OSD menu and select Power , select Auto-Sleep Mode , and then set auto-sleep to On .
“OSD Lockout” is displayed.	The monitor's OSD Lockout function is enabled.	Press and hold the Left button for 10 seconds to disable the OSD Lockout function.
“Power Button Lockout” is displayed.	The monitor's Power Button Lockout feature is enabled.	Press and hold the Power button for 10 seconds to unlock the power button function.
Monitor has trouble waking from Sleep mode		DisplayPort or USB Type-C inputs: Set the DisplayPort hot-plug detection to Always Active . Power mode monitors: Set the hot-plug detection to Always Active to switch the monitor to Performance mode.
Monitor is not displaying the preferred resolution or refresh rate.		Multi-streaming USB Type-C: Set the USB Type-C configuration to USB 2.x.
Slow performance from USB devices connected to the USB Type-A monitor connectors		Set the USB Type-C configuration to 3.x to enable better performance for integrated or connected USB Type-A devices.

Button lockouts

The button lockout function is available only when the monitor is on, an active signal is displayed, and the OSD menu is closed. Holding down the power button or **Menu** button for 10 seconds disables that button. You can re-enable the button by holding it down again for 10 seconds.

Optimizing image performance (VGA input)

If you would like to customize your settings, this section describes how to manually optimize your monitor's image.

You can adjust two controls in the on-screen display to improve image performance: **Clock** and **Phase** (available in the OSD menu). Use these controls only when the auto-adjustment function does not provide a satisfactory image.



NOTE: You can adjust the **Clock** and **Phase** controls only when you use an analog (VGA) input. These controls are not adjustable for digital inputs.

The **Clock** must first be set correctly because the **Phase** settings are dependent on the main **Clock** setting.

- **Clock**—Increases or decreases the value to minimize any vertical bars or stripes visible on the screen background.

- **Phase**—Increases or decreases the value to minimize video flickering or blurring.



NOTE: When you use the controls, you will obtain the best results by using the auto-adjustment pattern software utility. You can download this utility from <http://www.hp.com/support>.

When adjusting the Clock and Phase values, if the monitor images become distorted, continue adjusting the values until the distortion disappears. To restore the factory settings, press the **Menu** button to open the OSD menu, then select **Management**, select **Factory Reset**, and select **Yes**.

To eliminate vertical bars (Clock):

1. Press the **Menu** button to open the OSD menu, select **Image**, and then select **Clock and Phase**.
2. Select **Clock**, and then use the OSD buttons on the monitor that display up and down arrow icons to eliminate vertical bars. Press the buttons slowly so that you do not miss the optimum adjustment point.



3. After adjusting the Clock, if flickering, blurring, or bars appear on the screen, proceed to adjust the Phase.

To remove flickering or blurring (Phase):

1. Press the **Menu** button to open the OSD menu, select **Image**, and then select **Clock and Phase**.
2. Select **Phase**, and then use the OSD buttons on the monitor that display up and down arrow icons to eliminate flickering or blurring. Flickering or blurring might not be eliminated, depending on the computer or graphics controller card installed.

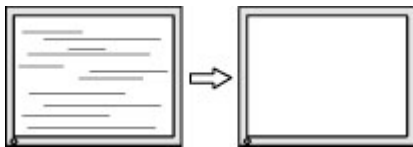

To correct screen position (Horizontal Position or Vertical Position):

1. Press the **Menu** button to open the OSD menu, select **Image**, and then select **Image Position**.
2. Press the OSD buttons on the monitor that display up and down arrow icons to properly adjust the position of the image in the display area of the monitor. The **Horizontal Position** shifts the image left or right; the **Vertical Position** shifts the image up or down.

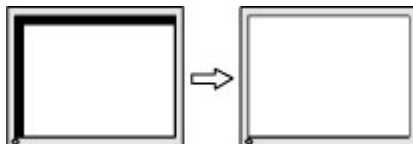

4 Maintaining the monitor

Properly maintained, your monitor can run for many years. These instructions provide steps you can perform to keep your monitor in the best condition.

Maintenance guidelines

Follow these instructions to enhance the performance and extend the life of the monitor.

- Do not open the monitor cabinet or attempt to service this product yourself. Adjust only those controls that are covered in the operating instructions. If the monitor is not operating properly or has been dropped or damaged, contact an authorized HP dealer, reseller, or service provider.
- Use only a power source and connection appropriate for this monitor, as indicated on the label or back plate of the monitor.
- Be sure that the total ampere rating of the products connected to the outlet does not exceed the current rating of the AC outlet and that the total ampere rating of the products connected to the cord does not exceed the rating of the cord. Look on the power label to determine the ampere rating (AMPS or A) for each device.
- Install the monitor near an outlet that you can easily reach. Disconnect the monitor by grasping the plug firmly and pulling it from the outlet. Never disconnect the monitor by pulling the cord.
- Turn the monitor off when it is not in use, and use a screen saver program. Doing this can substantially increase the life expectancy of the monitor.



NOTE: A burned-in image on the monitor is not covered under the HP warranty.

- Never block the slots and openings of the cabinet or push objects into them. These openings provide ventilation.
- Do not drop the monitor or place it on an unstable surface.
- Do not allow anything to rest on the power cord. Do not walk on the cord.
- Keep the monitor in a well-ventilated area, away from excessive light, heat, or moisture.

Cleaning the monitor

Use these instructions to clean your monitor when necessary.

1. Turn off the monitor and unplug the power cord from the AC outlet.
2. Disconnect any external devices.
3. Dust the monitor by wiping the screen and the cabinet with a soft, clean antistatic cloth.
4. For more difficult cleaning situations, use a 50/50 mix of water and isopropyl alcohol.



IMPORTANT: Do not use cleaners that contain petroleum-based materials such as benzene, thinner, or any volatile substance to clean the monitor screen or cabinet. These chemicals might damage the monitor.

 **IMPORTANT:** Spray the cleaner onto a cloth and use the damp cloth to gently wipe the screen surface. Never spray the cleaner directly on the screen surface. It can run behind the bezel and damage the electronics. The cloth should be moist, but not wet. Water dripping into the ventilation openings or other points of entry can cause damage to the monitor. Allow the monitor to air-dry before use.

5. After you remove the dirt and debris, you can also clean the surfaces with a disinfectant. The World Health Organization (WHO) recommends cleaning surfaces, followed by disinfection, as a best practice for preventing the spread of viral respiratory illnesses and harmful bacteria. A disinfectant that is within HP's cleaning guidelines is an alcohol solution consisting of 70% isopropyl alcohol and 30% water. This solution is also known as rubbing alcohol and is sold in most stores.

Shipping the monitor

Keep the original packing box in a storage area. You might need it later if you ship the monitor or move.

A Technical specifications

This section contains technical specifications for the physical aspects of your monitor, such as the weight and viewing dimensions, as well as required environmental operating conditions and power source ranges.

All specifications represent the typical specifications provided by HP component manufacturers; actual performance can vary either higher or lower.

 **NOTE:** For the latest specifications or additional specifications for this product, go to <http://www.hp.com/go/quickspecs/> and search for your specific monitor model to find the model-specific QuickSpecs.

80.01 cm (31.5 in) model specifications

This section provides specifications for your monitor.

Table A-1 Technical specifications

Specification	Measurement	
Display, wide-screen	80.01 cm	31.5 in
Type	IPS	
Viewable image size	80.01 cm diagonal	31.5 in diagonal
Maximum weight (unpacked)	8.29 kg	18.28 lbs
Dimensions (include base)		
Height (highest position)	56.97 cm	22.43 in
Height (lowest position)	46.97 cm	18.49 in
Depth	22.53 cm	8.87 in
Width	71.44 cm	28.13 in
Tilt	-5° to 20°	
Environmental requirements temperature		
Operating temperature	5°C to 35°C	41°F to 95°F
Storage temperature	-40°C to 65°C	-40°F to 149°F
Storage humidity	5% to 95% (noncondensing)	
Power source	100 V ac to 240 V ac 50/60 Hz	
Video input terminal	One HDMI port, one DisplayPort connector, and one USB Type-C connector, three USB Type-A connectors	

68.58 cm (27 in) model specifications (fixed stand)

This section provides specifications for your monitor.

Table A-2 Technical specifications

Specification	Measurement	
Display, wide-screen	68.58 cm	27 in
Type	IPS	
Viewable image size	68.58 cm diagonal	27 in diagonal
Maximum weight (unpacked)	5.08 kg	11.19 lb
Dimensions (unpacked with stand)		
Height	43.84 cm	17.26 in
Depth	19.03 cm	7.49 in
Width	61.10 cm	24.06 in
Tilt	-5° to 20°	
Environmental requirements temperature		
Operating temperature	5°C to 35°C	41°F to 95°F
Storage temperature	-40°C to 65°C	-40°F to 149°F
Storage humidity	5% to 95% (noncondensing)	
Power source	100 V ac to 240 V ac 1.5 A 50/60 Hz	
Video input terminal	One HDMI port, one VGA port, and one DisplayPort connector	

68.58 cm (27 in) model specifications (height-adjustable stand)

This section provides specifications for your monitor.

Table A-3 Technical specifications

Specification	Measurement	
Display, wide-screen	68.58 cm	27 in
Type	IPS	
Viewable image size	68.58 cm diagonal	27 in diagonal
Maximum weight (unpacked)	5.75 kg	12.68 lb
Dimensions (unpacked with stand)		
Height	50.97 cm	20.07 in
Depth	20.23 cm	7.96 in
Width	61.10 cm	24.06 in
Tilt	-5° to 20°	
Environmental requirements temperature		

Table A-3 Technical specifications (continued)

Specification	Measurement	
Operating temperature	5°C to 35°C	41°F to 95°F
Storage temperature	-40°C to 65°C	-40°F to 149°F
Storage humidity	5% to 95% (noncondensing)	
Power source	100 V ac to 240 V ac 1.5 A 50/60 Hz	
Video input terminal	One HDMI port, one VGA port, and one DisplayPort connector	

68.58 cm (27 in) model specifications (curved)

This section provides specifications for your monitor.

Table A-4 Technical specifications

Specification	Measurement	
Display, wide-screen	68.58 cm	27 in
Type	IPS	
Viewable image size	68.6 cm diagonal	27 in diagonal
Maximum weight (unpacked)	5.03 kg	11.08 lb
Dimensions (unpacked with stand)		
Height	43.89 cm	17.28 in
Depth	19.03 cm	7.49 in
Width	61.05 cm	24.04 in
Tilt	-5° to 20°	
Environmental requirements temperature		
Operating temperature	5°C to 35°C	41°F to 95°F
Storage temperature	-40°C to 65°C	-40°F to 149°F
Storage humidity	5% to 95% (noncondensing)	
Power source	100 V ac to 240 V ac 1.5 A 50/60 Hz	
Video input terminal	One HDMI port and one DisplayPort connector	

60.45 cm (23.8 in) model specifications (fixed stand)

This section provides specifications for your monitor.

Table A-5 Technical specifications

Specification	Measurement	
Display, wide-screen	60.5 cm	23.8 in
Type	IPS	
Viewable image size	60.5 cm diagonal	23.8 in diagonal
Maximum weight (unpacked)	3.78 kg	8.32 lb
Dimensions (unpacked with stand)		
Height	39.79 cm	15.67 in
Depth	18.05 cm	7.11 in
Width	53.89 cm	21.22 in
Tilt	-5° to 23°	
Environmental requirements temperature		
Operating temperature	5°C to 35°C	41°F to 95°F
Storage temperature	-40°C to 65°C	-40°F to 149°F
Storage humidity	5% to 95% (noncondensing)	
Power source	100 V ac to 240 V ac 0.8 A 50/60 Hz	
Video input terminal	One HDMI port, one VGA port, and one DisplayPort connector	

60.45 cm (23.8 in) model specifications (height-adjustable stand)

This section provides specifications for your monitor.

Table A-6 Technical specifications

Specification	Measurement	
Display, wide-screen	60.45 cm	23.8 in
Type	IPS	
Viewable image size	60.5 cm diagonal	23.8 in diagonal
Maximum weight (unpacked)	3.78 kg	8.32 lb
Dimensions (unpacked with stand)		
Height	39.79 cm	15.67 in
Depth	18.05 cm	7.11 in
Width	63.89 cm	21.22 in
Tilt	-5° to 23°	
Environmental requirements temperature		

Table A-6 Technical specifications (continued)

Specification	Measurement	
Operating temperature	5°C to 35°C	41°F to 95°F
Storage temperature	-40°C to 65°C	-40°F to 149°F
Storage humidity	5% to 95% (noncondensing)	
Power source	100 V ac to 240 V ac 1.5 A 50/60 Hz	
Video input terminal	One HDMI port, one VGA port, and one DisplayPort connector	

60.45 cm (23.8 in) model specifications (VA model)

This section provides specifications for your monitor.

Table A-7 Technical specifications

Specification	Measurement	
Display, wide-screen	60.45 cm	23.8 in
Type	VA	
Viewable image size	60.5 cm diagonal	23.8 in diagonal
Maximum weight (unpacked)	3.36 kg	7.41 lb
Dimensions (unpacked with stand)		
Height	39.79 cm	15.67 in
Depth	18.05 cm	7.11 in
Width	53.89 cm	21.22 in
Tilt	-5° to 23°	
Environmental requirements temperature		
Operating temperature	5°C to 35°C	41°F to 95°F
Storage temperature	-40°C to 65°C	-40°F to 149°F
Storage humidity	5% to 95% (noncondensing)	
Power source	100 V ac to 240 V ac 1.5 A 50/60 Hz	
Video input terminal	One HDMI port and one VGA port	

54.61 cm (21.5 in) model specifications

This section provides specifications for your monitor.

Table A-8 Technical specifications

Specification	Measurement	
Display, wide-screen	54.61 cm	21.5 in
Type	IPS	
Viewable image size	54.61 cm diagonal	21.5 in diagonal
Maximum weight (unpacked, with stand)	3.25 kg	7.17 lbs
Dimensions (include base)		
Height	37.82 cm	14.89 in
Depth	18.04 cm	7.10 in
Width	48.80 cm	19.21 in
Tilt	-5° to 23°	
Environmental requirements temperature		
Operating temperature	5°C to 35°C	41°F to 95°F
Storage temperature	-40°C to 65°C	-40°F to 149°F
Storage humidity	5% to 95%	
Power source	100 V ac to 240 V ac 1.5 A 50/60 Hz	
Video input terminal	One HDMI port, one DisplayPort connector, and one VGA port	

54.61 cm (21.5 in) model specifications (height-adjustable stand)

This section provides specifications for your monitor.

Table A-9 Technical specifications

Specification	Measurement	
Display, wide-screen	54.61 cm	21.5 in
Type	IPS	
Viewable image size	54.61 cm diagonal	21.5 in diagonal
Maximum weight (unpacked, with stand)	4.05 kg	8.93 lbs
Dimensions (include base)		
Height	44.95 cm	17.7 in
Depth	19.64 cm	7.73 in
Width	48.84 cm	19.23 in
Tilt	-5° to 23°	

Table A-9 Technical specifications (continued)

Specification	Measurement	
Environmental requirements temperature		
Operating temperature	5°C to 35°C	41°F to 95°F
Storage temperature	-20°C to 60°C	-4°F to 140°F
Storage humidity		5% to 95%
Power source	100 V ac to 240 V ac 1.5 A 50/60 Hz	
Video input terminal	One HDMI port, one DisplayPort connector, and one VGA port	

54.48 cm (21.45 in) model specifications

This section provides specifications for your monitor.

Table A-10 Technical specifications

Specification	Measurement	
Display, wide-screen	54.48 cm	21.45 in
Type	VA	
Viewable image size	54.48 cm diagonal	21.45 in diagonal
Maximum weight (unpacked, with stand)	2.8 kg	6.17 lbs
Dimensions (include base)		
Height	38.69 cm	15.23 in
Depth	18.05 cm	7.11 in
Width	50.42 cm	19.85 in
Tilt	-5° to 23°	
Environmental requirements temperature		
Operating temperature	5°C to 35°C	41°F to 95°F
Storage temperature	-40°C to 65°C	-40°F to 149°F
Storage humidity		5% to 95%
Power source	100 V ac to 240 V ac 1.5 A 50/60 Hz	
Video input terminal	One HDMI port and one VGA port	

Preset display resolutions

The following display resolutions are the most commonly used modes and are set as factory defaults. The monitor automatically recognizes these preset modes, and they will appear properly sized and centered on the screen.

80.01 cm (31.5 in) model

This section provides preset display resolutions and preset timing resolutions.

Table A-11 Preset display resolutions

Preset	Pixel format	Horz freq (kHz)	Vert freq (Hz)
1	640 × 480	31.469	59.940
2	640 × 480	37.500	75.000 (HDMI only)
3	720 × 400	31.469	70.087
4	800 × 600	37.879	60.317
5	800 × 600	46.875	75.000
6	1024 × 768	48.363	60.004
7	1024 × 768	60.023	75.029
8	1280 × 720	45.000	60.000
9	1280 × 800	49.702	59.810
10	1280 × 1024	63.981	60.020
11	1280 × 1024	79.976	75.025
12	1440 × 900	55.935	59.987
13	1440 × 900	55.469	59.901
14	1600 × 900	60.000	60.000
15	1680 × 1050	65.290	59.954
16	1920 × 1080	67.500	60.000
17	1920 × 1200	74.038	59.950
18	2560 × 1440	88.787	59.951
19	2560 × 1440	111.857	74.971

Table A-12 Preset timing resolutions

Preset	Timing name	Pixel format	Horz freq (kHz)	Vert freq (Hz)
1	480p	640 × 480	31.469	59.94
2	480p	720 × 480	31.469	60.000
3	576p	720 × 526	31.250	50.000
4	720p50	1280 × 720	37.500	50.000
5	720p60	1280 × 720	45.000	60.000
6	1080p60	1920 × 1080	67.500	60.000
7	1080p50	1920 × 1080	56.250	50.000
8	1440p60	2560 × 1440	88.787	60.000

68.58 cm (27 in) model

This section provides preset display resolutions and preset timing resolutions.

Table A-13 Preset display resolutions

Preset	Pixel format	Horz freq (kHz)	Vert freq (Hz)
1	640 × 480	31.469	59.940
2	640 × 480	31.500	75.000 (Digital port only)
3	720 × 400	31.469	70.087
4	800 × 600	37.879	60.317
5	800 × 600	46.875	75.000 (Digital port only)
6	1024 × 768	48.363	60.004
7	1024 × 768	60.023	75.029 (Digital port only)
8	1280 × 720	45.000	60.000
9	1280 × 800	49.702	59.810
10	1280 × 1024	63.981	60.020
11	1280 × 1024	79.976	72.025 (Digital port only)
12	1440 × 900	55.935	59.987
13	1440 × 900	55.469	59.901
14	1600 × 900	60.000	60.000
15	1680 × 1050	65.290	59.954
16	1920 × 1080	67.500	60.000
17	1920 × 1080	83.894	74.973

Table A-14 Preset timing resolutions

Preset	Timing name	Pixel format	Horz freq (kHz)	Vert freq (Hz)
1	480p	720 × 480	31.469	59.940
2	480p	720 × 480	31.469	59.940
3	576p	720 × 576	31.250	50.000
4	720p50	1280 × 720	37.500	50.000
5	720p60	1280 × 720	45.000	60.000
6	1080p50	1920 × 1080	56.250	50.000
7	1080p60	1920 × 1080	67.500	60.000

68.58 cm (27 in) curved model

This section provides preset display resolutions and preset timing resolutions.

Table A-15 Preset display resolutions

Preset	Pixel format	Horz freq (kHz)	Vert freq (Hz)
1	640 × 480	31.469	59.940
2	640 × 480	31.500	75.000 (Digital port only)
3	720 × 400	31.469	70.087
4	800 × 600	37.879	60.317
5	800 × 600	46.875	75.000 (Digital port only)
6	1024 × 768	48.363	60.004
7	1024 × 768	60.023	75.029 (Digital port only)
8	1280 × 720	45.000	60.000
9	1280 × 800	49.702	59.810
10	1280 × 1024	63.981	60.020
11	1280 × 1024	79.976	72.025 (Digital port only)
12	1440 × 900	55.935	59.987
13	1440 × 900	55.469	59.901
14	1600 × 900	60.000	60.000
15	1680 × 1050	65.290	59.954
16	1920 × 1080	67.500	60.000
17	1920 × 1080	83.894	74.973

Table A-16 Preset timing resolutions

Preset	Timing name	Pixel format	Horz freq (kHz)	Vert freq (Hz)
1	480p	720 × 480	31.469	59.940
2	480p	720 × 480	31.469	59.940
3	576p	720 × 576	31.250	50.000
4	720p50	1280 × 720	37.500	50.000
5	720p60	1280 × 720	45.000	60.000
6	1080p50	1920 × 1080	56.250	50.000
7	1080p60	1920 × 1080	67.500	60.000

60.45 cm (23.8 in) model

This section provides preset display resolutions and preset timing resolutions.

Table A-17 Preset display resolutions

Preset	Pixel format	Horz freq (kHz)	Vert freq (Hz)
1	640 × 480	31.469	59.940

Table A-17 Preset display resolutions (continued)

Preset	Pixel format	Horz freq (kHz)	Vert freq (Hz)
2	640 × 480	31.500	75.000 (Digital port only)
3	720 × 400	31.469	70.087
4	800 × 600	37.879	60.317
5	800 × 600	46.875	75.000 (Digital port only)
6	1024 × 768	48.363	60.004
7	1024 × 768	60.023	75.029 (Digital port only)
8	1280 × 720	45.000	60.000
9	1280 × 800	49.702	59.810
10	1280 × 1024	63.981	60.020
11	1280 × 1024	79.976	72.025 (Digital port only)
12	1440 × 900	55.935	59.987
13	1440 × 900	55.469	59.901
14	1600 × 900	60.000	60.000
15	1680 × 1050	65.290	59.954
16	1920 × 1080	67.500	60.000
17	1920 × 1080	83.894	74.973 (Digital port only)

Table A-18 Preset timing resolutions

Preset	Timing name	Pixel format	Horz freq (kHz)	Vert freq (Hz)
1	480p	720 × 480	31.469	59.940
2	480p	720 × 480	31.469	59.940
3	576p	720 × 576	31.250	50.000
4	720p50	1280 × 720	37.500	50.000
5	720p60	1280 × 720	45.000	60.000
6	1080p50	1920 × 1080	56.250	50.000
7	1080p60	1920 × 1080	67.500	60.000

54.61 cm (21.5 in) models

This section provides preset display resolutions.

Table A-19 Preset display resolutions

Preset	Pixel format	Horz freq (kHz)	Vert freq (Hz)
1	640 × 480	31.469	59.940
2	640 × 480	31.500	75.000 (Digital port only)

Table A-19 Preset display resolutions (continued)

Preset	Pixel format	Horz freq (kHz)	Vert freq (Hz)
3	720 × 400	31.469	70.087
4	800 × 600	37.879	60.317
5	800 × 600	46.875	75.000 (Digital port only)
6	1024 × 768	48.363	60.004
7	1024 × 768	60.023	75.029 (Digital port only)
8	1280 × 720	45.000	60.000
9	1280 × 800	49.702	59.810
10	1280 × 1024	63.981	60.020
11	1280 × 1024	79.976	72.025 (Digital port only)
12	1440 × 900	55.935	59.987
13	1440 × 900	55.469	59.901
14	1600 × 900	60.000	60.000
15	1680 × 1050	65.290	59.954
16	1920 × 1080	67.500	60.000
17	1920 × 1080	83.894	74.973

Table A-20 Preset timing resolutions

Preset	Timing name	Pixel format	Horz freq (kHz)	Vert freq (Hz)
1	480p	720 × 480	31.469	59.940
2	480p	720 × 480	31.469	59.940
3	576p	720 × 576	31.250	50.000
4	720p50	1280 × 720	37.500	50.000
5	720p60	1280 × 720	45.000	60.000
6	1080p50	1920 × 1080	56.250	50.000
7	1080p60	1920 × 1080	67.500	60.000

54.48 cm (21.45 in) models

This section provides preset display resolutions.

Table A-21 Preset display resolutions

Preset	Pixel format	Horz freq (kHz)	Vert freq (Hz)
1	640 × 480	31.469	59.940
2	640 × 480	31.500	75.000 (Digital port only)
3	720 × 400	31.469	70.087

Table A-21 Preset display resolutions (continued)

Preset	Pixel format	Horz freq (kHz)	Vert freq (Hz)
4	800 × 600	37.879	60.317
5	800 × 600	46.875	75.000 (Digital port only)
6	1024 × 768	48.363	60.004
7	1024 × 768	60.023	75.029 (Digital port only)
8	1280 × 720	45.000	60.000
9	1280 × 800	49.702	59.810
10	1280 × 1024	63.981	60.020
11	1280 × 1024	79.976	72.025 (Digital port only)
12	1440 × 900	55.935	59.987
13	1440 × 900	55.469	59.901
14	1600 × 900	60.000	60.000
15	1680 × 1050	65.290	59.954
16	1920 × 1080	67.500	60.000
17	1920 × 1080	83.894	74.973

Table A-22 Preset timing resolutions

Preset	Timing name	Pixel format	Horz freq (kHz)	Vert freq (Hz)
1	480p	720 × 480	31.469	59.940
2	480p	720 × 480	31.469	59.940
3	576p	720 × 576	31.250	50.000
4	720p50	1280 × 720	37.500	50.000
5	720p60	1280 × 720	45.000	60.000
6	1080p50	1920 × 1080	56.250	50.000
7	1080p60	1920 × 1080	67.500	60.000

High-definition video formats

This section provides high-definition video formats.

Table A-23 High-definition video formats

Preset	Timing name	Pixel format	Horz freq (kHz)	Vert freq (Hz)
1	480p	640 × 480	31.469	59.94
2	480p	720 × 480	31.469	59.94
3	576p	720 × 576	31.250	50.00
4	720p50	1280 × 720	37.500	50.00

Table A-23 High-definition video formats (continued)

Preset	Timing name	Pixel format	Horz freq (kHz)	Vert freq (Hz)
5	720p60	1280 × 720	45.000	60.00
6	1080p50	1920 × 1080	56.250	50.00
7	1080p60	1920 × 1080	67.500	60.00

Energy saver feature

This monitor supports a reduced power state.

The reduced power state is initiated if the monitor detects the absence of either the horizontal sync signal or the vertical sync signal. Upon detecting the absence of these signals, the monitor screen is blank, the backlight is turned off, and the power light turns amber. In the reduced power state, the monitor uses < 0.5 W of power. There is a brief warm-up period before the monitor returns to its normal operating state.

See the computer manual for instructions on setting the energy saver mode (sometimes called “power management feature”).



NOTE: This power saver feature works only when the monitor is connected to a computer that has energy-saver features.

By selecting the settings in the monitor Sleep Timer utility, you can also program the monitor to initiate the reduced power state at a predetermined time. When the monitor Sleep Timer utility initiates the reduced power state, the power light blinks amber.

B Accessibility

HP's goal is to design, produce, and market products, services, and information that everyone everywhere can use, either on a stand-alone basis or with appropriate third-party assistive technology (AT) devices or applications.

HP and accessibility

Because HP works to weave diversity, inclusion, and work/life into the fabric of the company, it is reflected in everything HP does. HP strives to create an inclusive environment focused on connecting people to the power of technology throughout the world.

Finding the technology tools you need

Technology can unleash your human potential. Assistive technology removes barriers and helps you create independence at home, at work, and in the community. Assistive technology helps increase, maintain, and improve the functional capabilities of electronic and information technology.

For more information, see [Finding the best assistive technology on page 44](#).

The HP commitment

HP is committed to providing products and services that are accessible for people with disabilities. This commitment supports the company's diversity objectives and helps ensure that the benefits of technology are available to all.

The HP accessibility goal is to design, produce, and market products and services that can be effectively used by everyone, including people with disabilities, either on a stand-alone basis or with appropriate assistive devices.

To achieve that goal, this Accessibility Policy establishes seven key objectives to guide HP actions. All HP managers and employees are expected to support these objectives and their implementation in accordance with their roles and responsibilities:

- Raise the level of awareness of accessibility issues within HP, and provide employees with the training they need to design, produce, market, and deliver accessible products and services.
- Develop accessibility guidelines for products and services, and hold product development groups accountable for implementing these guidelines where competitively, technically, and economically feasible.
- Involve people with disabilities in the development of accessibility guidelines and in the design and testing of products and services.
- Document accessibility features, and make information about HP products and services publicly available in an accessible form.
- Establish relationships with leading assistive technology and solution providers.
- Support internal and external research and development that improves assistive technology relevant to HP products and services.
- Support and contribute to industry standards and guidelines for accessibility.

International Association of Accessibility Professionals (IAAP)

IAAP is a not-for-profit association focused on advancing the accessibility profession through networking, education, and certification. The objective is to help accessibility professionals develop and advance their careers and to better enable organizations to integrate accessibility into their products and infrastructure.

As a founding member, HP joined to participate with other organizations to advance the field of accessibility. This commitment supports HP's accessibility goal of designing, producing, and marketing products and services that people with disabilities can effectively use.

IAAP will make the profession strong by globally connecting individuals, students, and organizations to learn from one another. If you are interested in learning more, go to <http://www.accessibilityassociation.org> to join the online community, sign up for newsletters, and learn about membership options.

Finding the best assistive technology

Everyone, including people with disabilities or age-related limitations, should be able to communicate, express themselves, and connect with the world using technology. HP is committed to increasing accessibility awareness within HP and with our customers and partners.

Whether it's large fonts that are easy on the eyes, voice recognition that lets you give your hands a rest, or any other assistive technology to help with your specific situation—a variety of assistive technologies make HP products easier to use. How do you choose?

Assessing your needs

Technology can unleash your potential. Assistive technology removes barriers and helps you create independence at home, at work, and in the community. Assistive technology (AT) helps increase, maintain, and improve the functional capabilities of electronic and information technology.

You can choose from many AT products. Your AT assessment should allow you to evaluate several products, answer your questions, and facilitate your selection of the best solution for your situation. You will find that professionals qualified to do AT assessments come from many fields, including those licensed or certified in physical therapy, occupational therapy, speech/language pathology, and other areas of expertise. Others, while not certified or licensed, can also provide evaluation information. You will want to ask about the individual's experience, expertise, and fees to determine if they are appropriate for your needs.

Accessibility for HP products

These links provide information about accessibility features and assistive technology, if applicable and available in your country or region, that are included in various HP products. These resources will help you select the specific assistive technology features and products most appropriate for your situation.

- **HP Aging & Accessibility:** Go to <http://www.hp.com>, type **Accessibility** in the search box. Select **Office of Aging and Accessibility**.
- **HP computers:** For Windows products, go to <http://www.hp.com/support>, type **Windows Accessibility Options** in the **Search our knowledge** search box. Select the appropriate operating system in the results.
- **HP Shopping, peripherals for HP products:** Go to <http://store.hp.com>, select **Shop**, and then select **Monitors or Accessories**.

If you need additional support with the accessibility features on your HP product, see [Contacting support on page 47](#).

Additional links to external partners and suppliers that may provide additional assistance:

- [Microsoft Accessibility information \(Windows and Microsoft Office\)](#)
- [Google Products accessibility information \(Android, Chrome, Google Apps\)](#)

Standards and legislation

Countries worldwide are enacting regulations to improve access to products and services for persons with disabilities. These regulations are historically applicable to telecommunications products and services, PCs and printers with certain communications and video playback features, their associated user documentation, and their customer support.

Standards

The US Access Board created Section 508 of the Federal Acquisition Regulation (FAR) standards to address access to information and communication technology (ICT) for people with physical, sensory, or cognitive disabilities.

The standards contain technical criteria specific to various types of technologies, as well as performance-based requirements which focus on functional capabilities of covered products. Specific criteria cover software applications and operating systems, web-based information and applications, computers, telecommunications products, video and multimedia, and self-contained closed products.

Mandate 376 – EN 301 549

The European Union created the EN 301 549 standard within Mandate 376 as an online toolkit for public procurement of ICT products. The standard specifies the accessibility requirements applicable to ICT products and services, with a description of the test procedures and evaluation methodology for each requirement.

Web Content Accessibility Guidelines (WCAG)

Web Content Accessibility Guidelines (WCAG) from the W3C's Web Accessibility Initiative (WAI) helps web designers and developers create sites that better meet the needs of people with disabilities or age-related limitations.

WCAG advances accessibility across the full range of web content (text, images, audio, and video) and web applications. WCAG can be precisely tested, is easy to understand and use, and allows web developers flexibility for innovation. WCAG 2.0 has also been approved as [ISO/IEC 40500:2012](#).

WCAG specifically addresses barriers to accessing the web experienced by people with visual, auditory, physical, cognitive, and neurological disabilities, and by older web users with accessibility needs. WCAG 2.0 provides characteristics of accessible content:

- **Perceivable** (for instance, by addressing text alternatives for images, captions for audio, adaptability of presentation, and color contrast)
- **Operable** (by addressing keyboard access, color contrast, timing of input, seizure avoidance, and navigability)
- **Understandable** (by addressing readability, predictability, and input assistance)
- **Robust** (for instance, by addressing compatibility with assistive technologies)

Legislation and regulations

Accessibility of IT and information has become an area of increasing legislative importance. These links provide information about key legislation, regulations, and standards.

- [United States](#)
- [Canada](#)
- [Europe](#)
- [Australia](#)

Useful accessibility resources and links

These organizations, institutions, and resources might be good sources of information about disabilities and age-related limitations.



NOTE: This is not an exhaustive list. These organizations are provided for informational purposes only. HP assumes no responsibility for information or contacts you encounter on the internet. Listing on this page does not imply endorsement by HP.

Organizations

These organizations are a few of the many that provide information about disabilities and age-related limitations.

- American Association of People with Disabilities (AAPD)
- The Association of Assistive Technology Act Programs (ATAP)
- Hearing Loss Association of America (HLAA)
- Information Technology Technical Assistance and Training Center (ITTATC)
- Lighthouse International
- National Association of the Deaf
- National Federation of the Blind
- Rehabilitation Engineering & Assistive Technology Society of North America (RESNA)
- Telecommunications for the Deaf and Hard of Hearing, Inc. (TDI)
- W3C Web Accessibility Initiative (WAI)

Educational institutions

Many educational institutions, including these examples, provide information about disabilities and age-related limitations.

- California State University, Northridge, Center on Disabilities (CSUN)
- University of Wisconsin - Madison, Trace Center
- University of Minnesota computer accommodations program

Other disability resources

Many resources, including these examples, provide information about disabilities and age-related limitations.

- ADA (Americans with Disabilities Act) Technical Assistance Program

- ILO Global Business and Disability network
- EnableMart
- European Disability Forum
- Job Accommodation Network
- Microsoft Enable

HP links

These HP-specific links provide information that relates to disabilities and age-related limitations.

[HP comfort and safety guide](#)

[HP public sector sales](#)

Contacting support

HP offers technical support and assistance with accessibility options for customers with disabilities.



NOTE: Support is in English only.

- Customers who are deaf or hard of hearing who have questions about technical support or accessibility of HP products:
 - Use TRS/VRS/WebCapTel to call (877) 656-7058 Monday through Friday, 6 a.m. to 9 p.m. Mountain Time.
- Customers with other disabilities or age-related limitations who have questions about technical support or accessibility of HP products:
 - Call (888) 259-5707 Monday through Friday, 6 a.m. to 9 p.m. Mountain Time.

Index

A

- accessibility 43-45, 47
- accessibility needs assessment 44
- assistive technology (AT)
 - finding 44
 - purpose 43
- AT (assistive technology)
 - finding 44
 - purpose 43
- auto-adjustment (analog input) 23

C

- calling technical support 2
- components
 - front 3
 - rear 4
- connectors
 - DisplayPort 4
 - mini DisplayPort 4
 - power 4
- customer support, accessibility 47

D

- diagnostics 23
- DisplayPort connector 4

F

- front components 3

G

- getting started 1
- getting to know your monitor 2

H

- HDMI port 4
- HP Assistive Policy 43
- HP Display Center 18
- HP resources 1
- HP support 1

I

- internal diagnostics 23
- International Association of Accessibility Professionals 44

M

- menu button 3

O

- optimizing image performance
 - (analog input) 23, 25
- OSD button 3

P

- ports
 - HDMI 4
 - USB Type-C 4
- power connector 4

R

- rear components 4
- resources, accessibility 46

S

- safety information 1
- Section 508 accessibility standards 45
- standards and legislation, accessibility 45
- support 2

T

- technical support 2

U

- USB Type-C port 4

W

- warnings 1