

Version 1.0
June 2021
702P08624

Xerox® B225/B235 Multifunction Printer User Guide

© 2021 Xerox Corporation. All rights reserved. Xerox® and Xerox and Design® are trademarks of Xerox Corporation in the United States and other countries.

Adobe®, Adobe PDF logo, Adobe® Reader®, Adobe® Type Manager®, ATM™, Flash®, Macromedia®, Photoshop®, and PostScript® are trademarks or registered trademarks of Adobe Systems, Inc.

Apple®, Bonjour®, EtherTalk™, TrueType®, iPad®, iPhone®, iPod®, iPod touch®, AirPrint® and the AirPrint Logo®, Mac®, Mac OS®, and Macintosh® are trademarks or registered trademarks of Apple Inc. in the U.S. and other countries.

Gmail™ webmail service, and Android™ mobile technology platform are trademarks of Google, Inc.

HP-GL®, HP-UX®, and PCL® are registered trademarks of Hewlett-Packard Corporation in the United States and/or other countries.

IBM® and AIX® are registered trademarks of International Business Machines Corporation in the United States and/or other countries.

McAfee®, ePolicy Orchestrator®, and McAfee ePO™ are trademarks or registered trademarks of McAfee, Inc. in the United States and other countries.

Microsoft®, Windows Vista®, Windows®, Windows Server®, and OneDrive® are registered trademarks of Microsoft Corporation in the United States and other countries.

Mopria is a trademark of the Mopria Alliance.

PANTONE® and other Pantone, Inc. trademarks are the property of Pantone, Inc.

UNIX® is a trademark in the United States and other countries, licensed exclusively through X/ Open Company Limited.

Linux® is a registered trademark of Linus Torvalds.

Wi-Fi CERTIFIED Wi-Fi Direct® is a trademark of the Wi-Fi Alliance.

PCL® is a registered trademark of the Hewlett-Packard Company. PCL is a designation of a set of printer commands (language) and functions included in its printer products. This printer is intended to be compatible with the PCL language. This means the printer recognizes PCL commands used in various application programs, and that the printer emulates the functions corresponding to the commands.

All other trademarks are the property of their respective owners.

Table of Contents

1 Safety	11
Conventions.....	12
Product Statements	13
Maintenance Safety.....	16
Consumable Information	17
2 Learn about the printer	19
Printer configuration	20
Using the control panel.....	21
Non-touch Screen Model.....	21
Touch Screen Model.....	22
Customizing the home screen	23
Changing the language of the keyboard on the display.....	24
Understanding the status of the power button and indicator light.....	25
Selecting paper	26
Paper guidelines	26
Paper characteristics	26
Unacceptable paper.....	27
Selecting preprinted forms and letterhead	27
Storing paper.....	28
Supported paper sizes	28
Supported paper types.....	30
Supported paper weights	31
3 Set up, install, and configure.....	33
Selecting a location for the printer	34
Attaching cables	36
Finding the IP Address of the Printer	38
Setting up the printer to fax.....	39
Setting up the fax function	39
Setting up fax using a standard telephone line.....	40
Setting Up Fax in Countries or Regions with Different Telephone Wall Jacks and Plugs.....	41
Connecting to a distinctive ring service	43
Setting the fax date and time	43
Configuring daylight saving time	44
Configuring the fax speaker settings	44
Configuring the Email SMTP Settings.....	45
Using the Email Setup Wizard in the Printer	45

Table of Contents

Using the Settings Menu in the Printer	45
Using the Embedded Web Server	45
Email Service Providers.....	46
Loading paper and specialty media.....	54
Setting the Paper Size and Type	54
Configuring Universal paper settings.....	54
Loading the Tray.....	54
Loading the Manual Feeder	56
Installing and updating software, drivers, and firmware	57
Installing the Software	57
Updating Firmware.....	60
Exporting or importing a configuration file.....	61
Networking.....	62
Connecting the Printer to a Wi-Fi Network	62
Connecting the printer to a wireless network using Wi-Fi Protected Setup (WPS)	62
Configuring Wi-Fi Direct.....	63
Connecting a Mobile Device to the Printer.....	64
Connecting a Computer to the Printer.....	64
Deactivating the Wi-Fi network.....	65
Checking the printer connectivity.....	65
Printing the Menu Settings Page	66
4 Secure the printer	67
Erasing printer memory.....	68
Restoring factory default settings.....	69
Statement of Volatility.....	70
5 Print	71
Printing from a Computer	72
Printing from a Mobile Device	73
Printing from a Mobile Device Using Mopria™ Print Service	73
Printing from a Mobile Device Using AirPrint®	73
Printing from a Mobile Device Using Wi-Fi Direct®.....	73
Printing from a flash drive.....	75
Supported flash drives and file types.....	76
Flash drives.....	76
File types	76
Configuring confidential jobs	77
Using the Control Panel	77
Using the Embedded Web Server	77
Printing confidential and other held jobs.....	78
For Windows users	78
For Macintosh users	78
Printing a font sample list	80
4 Xerox® B225/B235 Multifunction Printer User Guide	

Placing separator sheets between copies.....	81
Canceling a print job.....	82
From the printer control panel.....	82
From the computer	82
Adjusting toner darkness.....	83
6 Copy	85
Using the automatic document feeder and scanner glass.....	86
Making Copies	87
Copying photos.....	88
Copying on letterhead	89
Copying on Both Sides of the Paper	90
Reducing or enlarging copies.....	91
Copying multiple pages onto a single sheet	92
Collating copies	93
Copying cards	94
Creating a copy shortcut.....	95
7 Email	97
Using the automatic document feeder and scanner glass.....	98
Sending an Email.....	99
Using the Control Panel	99
Using a Shortcut Number.....	99
8 Fax	101
Using the automatic document feeder and scanner glass.....	102
Sending a Fax	103
Using the Control Panel	103
Scheduling a fax	104
Creating a fax destination shortcut	105
Changing the fax resolution	106
Adjusting the fax darkness	107
Printing a fax log.....	108
Blocking junk faxes	109
Holding a fax	110
Forwarding a fax.....	111
Using the control panel.....	111
Using the Embedded Web Server	111
9 Scan.....	113
Using the automatic document feeder and scanner glass.....	114
Scanning to a Computer	115

Table of Contents

For Windows users	115
For Macintosh users	115
Scanning to a flash drive.....	116
Scanning to an FTP server.....	117
Scanning to a network folder	118
10 Use printer menus.....	119
Menu Map.....	120
Device	121
Preferences	121
Eco-Mode	122
Remote Operator Panel.....	123
Notifications.....	123
Power Management.....	125
Restore Factory Defaults	126
Maintenance	126
Visible Home Screen Icons	129
About This Printer	129
Print.....	131
Layout	131
Setup.....	132
Quality.....	133
PDF	133
PostScript	134
PCL.....	134
Image	136
Paper	137
Tray Configuration.....	137
Media Configuration.....	137
Copy	140
Copy Defaults	140
Fax	142
Fax Defaults.....	142
E-mail	149
E-mail Setup	149
E-mail Defaults	150
FTP.....	154
FTP Defaults	154
USB Drive	157
Flash Drive Scan	157
Flash Drive Print.....	159
Network/Ports	161
Network Overview.....	161
Wireless	162
Wi-Fi Direct.....	165

Ethernet	165
TCP/IP	167
SNMP	169
IPSec	171
802.1x	172
LPD Configuration.....	172
HTTP/FTP Settings.....	173
USB	174
Restrict external network access.....	175
Security	176
Login Methods.....	176
Certificate Management.....	178
Schedule USB Devices.....	179
Login Restrictions.....	179
Erase Temporary Data Files.....	179
Miscellaneous	179
Reports	181
Menu Settings Page.....	181
Device	181
Print.....	181
Shortcuts	181
Fax	182
Network.....	182
Troubleshooting.....	183
11 Maintain the Printer.....	185
Checking the Status of Supplies	186
Configuring Supply Notifications.....	187
Setting up e-mail alerts.....	188
Viewing reports.....	189
Ordering Supplies.....	190
Using Genuine Xerox Supplies.....	190
Replacing Supplies	191
Replacing the Toner Cartridge.....	191
Replacing the imaging unit	193
Cleaning printer parts	196
Cleaning the printer.....	196
Cleaning the touch screen.....	196
Cleaning the Scanner.....	197
Saving energy and paper	199
Configuring power save mode settings.....	199
Adjusting the brightness of the display	199
Conserving supplies.....	199
Moving the Printer to Another Location.....	200
12 Troubleshoot a problem.....	201

Table of Contents

Print quality problems	202
Printing problems.....	203
Print quality is poor.....	203
Print jobs do not print	236
Job prints from the wrong tray or on the wrong paper.....	237
Slow printing.....	237
The printer is not responding	241
Unable to read flash drive.....	243
Enabling the USB port.....	244
Network connection problems.....	245
Cannot open Embedded Web Server	245
Cannot connect the printer to the Wi-Fi network.....	246
Issues with supplies	248
Replace cartridge, printer region mismatch — Use 708699	248
Non-Xerox Supplies.....	249
Clearing Jams	250
Avoiding Jams.....	250
Identifying Jam Locations.....	251
Paper Jam in the Tray	252
Paper Jam in the Front Door	253
Paper Jam in the Rear Door.....	256
Paper Jam in the Duplex Unit.....	257
Paper Jam in the Standard Output Tray	258
Paper Jam in the Manual Feeder	258
Paper Jam in the Automatic Document Feeder.....	258
Paper feed problems	261
Envelope seals when printing	261
Collated printing does not work.....	262
Paper frequently jams.....	263
Jammed pages are not reprinted	264
E-mailing problems	265
Disabling the SMTP server not set up error Message.....	265
Cannot send e-mails	265
Faxing problems.....	266
Cannot send or receive faxes.....	266
Can receive but not send faxes.....	268
Can send but not receive faxes.....	269
Poor fax print quality	270
Scanning problems	271
Cannot scan to a computer.....	271
Cannot scan to a network folder	272
Partial copies of document or photo.....	274
Scan job was not successful	275
Poor copy quality	276
Vertical dark streaks on output when scanning from the ADF	276
Scanner does not close.....	277

Scanning takes too long or freezes the computer	277
Scanner does not respond.....	278
Adjusting scanner registration.....	278
Adjusting ADF registration	279
Contacting Customer Support	280
A Regulatory Information	281
Basic Regulations.....	282
Noise Emission Levels.....	282
Static Sensitivity Notice	282
ENERGY STAR	282
Temperature Information.....	282
Información de la energía de México	283
Laser Notice.....	283
Power	283
Telecommunication Regulatory Notices.....	284
Regulatory Notices for Wireless Products.....	287
Federal Communications Commission (FCC) Compliance Information Statement.....	289
Innovation, Science and Economic Development Canada Compliance Statement	290
Germany.....	290
Turkey RoHS Regulation	290
Ukraine RoHS Compliance.....	290
Copy Regulations	291
United States.....	291
Canada.....	292
Other Countries.....	293
Material Safety Data Sheets	294
B Recycling and Disposal	295
Product Disposal and Recycling	296
North America	297
Xerox Green World Alliance	298
Waste from Electrical and Electronic Equipment (WEEE) Directive	299
India E-Waste notice.....	299

Table of Contents

Safety

This chapter contains:

- [Conventions](#)..... 12
- [Product Statements](#) 13
- [Maintenance Safety](#)..... 16
- [Consumable Information](#) 17

Your printer and the recommended supplies have been designed and tested to meet strict safety requirements. Attention to the following information ensures the continued safe operation of your Xerox printer.

Conventions



Note: A note identifies information that could help you.



Warning: A warning identifies something that could damage the product hardware or software.



Caution: A caution indicates a potentially hazardous situation that could injure you.

Different types of statements include:



CAUTION—POTENTIAL INJURY: Indicates a risk of injury.



CAUTION—SHOCK HAZARD: Indicates a risk of electrical shock.



CAUTION—HOT SURFACE: Indicates a risk of burn if touched.









CAUTION—PINCH HAZARD: Indicates a risk of being caught between moving parts.



CAUTION—MOVING PARTS: Indicates a risk of laceration or abrasion injuries from rotating parts.

Product Statements

-  **CAUTION—POTENTIAL INJURY:** To avoid the risk of fire or electrical shock, connect the power cord to an appropriately rated and properly grounded electrical outlet that is near the product and easily accessible.
-  **CAUTION—POTENTIAL INJURY:** To avoid the risk of fire or electrical shock, use only the power cord provided with this product or the manufacturer authorized replacement.
-  **CAUTION—POTENTIAL INJURY:** Do not use this product with extension cords, multi-outlet power strips, multi-outlet extenders, or UPS devices. The power capacity of these types of accessories can be easily overloaded by a laser printer and may result in a risk of fire, property damage, or poor printer performance.
-  **CAUTION—POTENTIAL INJURY:** Do not use this product with an inline surge protector. The use of a surge protection device may result in a risk of fire, property damage, or poor printer performance.
-  **CAUTION—POTENTIAL INJURY:** To reduce the risk of fire, use only a 26 AWG or larger telecommunications RJ-11 cord when connecting this product to the public switched telephone network. For users in Australia, the cord must be approved by the Australian Communications and Media Authority.
-  **CAUTION—SHOCK HAZARD:** To avoid the risk of electrical shock, do not place or use this product near water or wet locations.
-  **CAUTION—SHOCK HAZARD:** To avoid the risk of electrical shock, do not set up this product or make any electrical or cabling connections, such as the power cord, fax feature, or telephone, during a lightning storm.
-  **CAUTION—POTENTIAL INJURY:** Do not cut, twist, bind, crush, or place heavy objects on the power cord. Do not subject the power cord to abrasion or stress. Do not pinch the power cord between objects such as furniture and walls. If any of these things happen, a risk of fire or electrical shock results. Inspect the power cord regularly for signs of such problems. Remove the power cord from the electrical outlet before inspecting it.
-  **CAUTION—SHOCK HAZARD:** To avoid the risk of electrical shock, make sure that all external connections, such as Ethernet and telephone system connections, are properly installed in their marked plug-in ports.
-  **CAUTION—SHOCK HAZARD:** To avoid the risk of electrical shock, if you are accessing the controller board or installing optional hardware or memory devices sometime after setting up the printer, then turn the printer off, and unplug the power cord from the electrical outlet before continuing. If you have any other devices attached to the printer, then turn them off as well, and unplug any cables going into the printer.
-  **CAUTION—SHOCK HAZARD:** To avoid the risk of electrical shock, do not use the fax feature during a lightning storm.
-  **CAUTION—SHOCK HAZARD:** To avoid the risk of electrical shock when cleaning the exterior of the printer, unplug the power cord from the electrical outlet and disconnect all cables from the printer before proceeding.
-  **CAUTION—POTENTIAL INJURY:** If the printer weight is greater than 20kg (44lb), then it may require two or more people to lift it safely.

 **CAUTION—POTENTIAL INJURY:** When moving the printer, follow these guidelines to avoid personal injury or printer damage:

- Make sure that all doors and trays are closed.
- Turn off the printer, and then unplug the power cord from the electrical outlet.
- Disconnect all cords and cables from the printer.
- If the printer has separate floor-standing optional trays or output options attached to it, then disconnect them before moving the printer.
- If the printer has a caster base, then carefully roll it to the new location. Use caution when passing over thresholds and breaks in flooring.
- If the printer does not have a caster base but is configured with optional trays or output options, then remove the output options and lift the printer off the trays. Do not try to lift the printer and any options at the same time.
- Always use the handholds on the printer to lift it.
- Any cart used to move the printer must have a surface able to support the full footprint of the printer.
- Any cart used to move the hardware options must have a surface able to support the dimensions of the options.
- Keep the printer in an upright position.
- Avoid severe jarring movements.
- Make sure that your fingers are not under the printer when you set it down.
- Make sure that there is adequate clearance around the printer.

 **CAUTION—HOT SURFACE:** The inside of the printer might be hot. To reduce the risk of injury from a hot component, allow the surface to cool before touching it.

 **CAUTION—PINCH HAZARD:** To avoid the risk of a pinch injury, use caution in areas marked with this label. Pinch injuries may occur around moving parts, such as gears, doors, trays, and covers.

 **CAUTION—MOVING PARTS:** Indicates a risk of laceration or abrasion injuries from rotating parts.

 **CAUTION—POTENTIAL INJURY:** This product uses a laser. Use of controls or adjustments or performance of procedures other than those specified in the User Guide may result in hazardous radiation exposure.

 **CAUTION—POTENTIAL INJURY:** The lithium battery in this product is not intended to be replaced. There is a danger of explosion if a lithium battery is incorrectly replaced. Do not recharge, disassemble, or incinerate a lithium battery. Discard used lithium batteries according to the manufacturer instructions and local regulations.

This product is designed, tested, and approved to meet strict global safety standards with the use of specific manufacturer components. The safety features of some parts may not always be obvious. The manufacturer is not responsible for the use of other replacement parts.

Refer service or repairs, other than those described in the user documentation, to a service representative.

This product uses a printing process that heats the print media, and the heat may cause the media to release emissions. You must understand the section in your operating instructions that discusses the guidelines for selecting print media to avoid the possibility of harmful emissions.

This product may produce small amounts of ozone during normal operation, and may be equipped with a filter designed to limit ozone concentrations to levels well below the recommended exposure limits. To avoid high ozone concentration levels during extensive usage, install this product in a well-ventilated area and replace the ozone and exhaust filters if instructed to do so in the product maintenance instructions. If there are no references to filters in the product maintenance instructions, then there are no filters requiring replacement for this product.

SAVE THESE INSTRUCTIONS.

Maintenance Safety

Do not carry out any maintenance on this product that is not described in the customer documentation.



CAUTION—POTENTIAL INJURY: Do not use aerosol cleaners. Aerosol cleaners can be explosive or flammable when used on electromechanical equipment.

Use supplies and cleaning materials only as directed.

Do not remove the covers or guards that are fastened with screws. Customer service items are not located behind these covers.

In case of a Dry Ink or Toner Spill, use a broom or a wet cloth to wipe off spilled dry ink or toner. Sweep slowly to minimize generation of dust during clean up. Avoid using a vacuum. If a vacuum must be used, the unit should be designed for combustible dusts, having an explosion rated motor and non-conductive hose.



CAUTION—HOT SURFACE: The metallic surfaces in the fuser area are hot. Use caution when you remove paper jams from this area and avoid touching any metallic surfaces.

Consumable Information

 **CAUTION—POTENTIAL INJURY:** When handling cartridges such as ink or fuser, avoid skin or eye contact. Eye contact can cause irritation and inflammation. Do not attempt to disassemble the cartridge. This can increase the risk of skin or eye contact.

Store all consumables in accordance with the instructions given on the package or container.

Keep all consumables away from the reach of children.

Never throw dry ink/toner, print cartridges, or dry ink/toner containers into an open flame.

For information on Xerox® supplies recycling programs, go to: <https://www.xerox.com/recycling>.

Safety

Learn about the printer

This chapter contains:

- [Printer configuration](#) 20
- [Using the control panel](#)..... 21
- [Customizing the home screen](#) 23
- [Changing the language of the keyboard on the display](#)..... 24
- [Understanding the status of the power button and indicator light](#)..... 25
- [Selecting paper](#) 26

Printer configuration

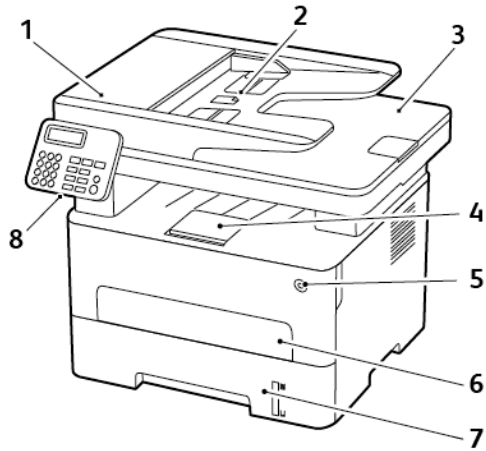

- | | |
|------------------------------------|-------------------|
| 1. Automatic document feeder (ADF) | 5. Power button |
| 2. ADF input tray | 6. Manual feeder |
| 3. ADF output tray | 7. 250-sheet tray |
| 4. Standard output tray | 8. Control panel |

 **Note:** The appearance may vary depending on your printer model.

Using the control panel

Non-touch Screen Model

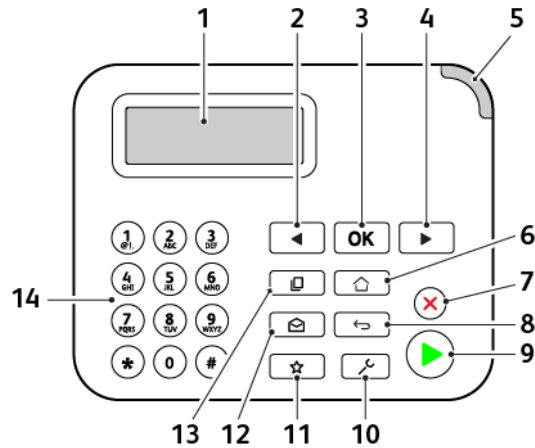

Number	Control panel part	Function
1	Display	<ul style="list-style-type: none"> View printer messages and supply status. Set up and operate the printer.
2	Left arrow button	<ul style="list-style-type: none"> Scroll through menus or move between screens and menu options. Decrease the numeric value of a setting.
3	Select button	<ul style="list-style-type: none"> Select a menu option. Save the changes in a setting.
4	Right arrow button	<ul style="list-style-type: none"> Scroll through menus or move between screens and menu options. Increase the numeric value of a setting.
5	Indicator light	Check the status of the printer.
6	Home button	Go to the home screen.
7	Stop or Cancel button	Stop the current job.
8	Back button	Return to the previous screen.
9	Start button	Start a job, depending on which mode is selected.
10	Menu button	Access the printer menus.
11	Shortcuts button	Access shortcuts to frequently used functions with previously saved settings.

Learn about the printer

Number	Control panel part	Function
12	Email button	Enter Email mode.
13	Copy button	Enter Copy mode.
14	Numeric keypad	Enter numbers or symbols in an input field.

Touch Screen Model

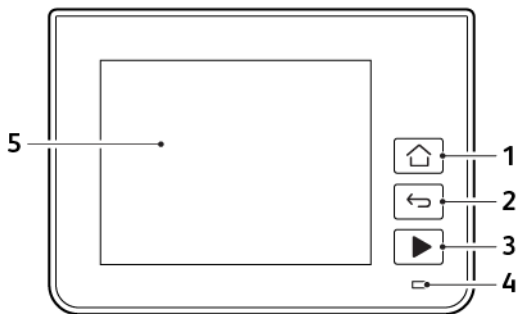

Number	Control panel part	Function
1	Home button	Go to the home screen.
2	Back button	Return to the previous screen.
3	Start button	Start a job, depending on which mode is selected.
4	Indicator light	Check the status of the printer.
5	Display	<ul style="list-style-type: none"> View printer messages and supply status. Set up and operate the printer.

Customizing the home screen

1. From the control panel, touch **Settings > Device > Visible Home Screen Icons**.
2. Select the icons that you want to appear on the home screen.
3. Apply the changes.

Changing the language of the keyboard on the display



Note: You can only change the language of the keyboard in printer tasks that require alphanumeric input such as e-mail or scan.

1. Touch the input field.
2. On the keyboard, touch and hold the language key.
3. Select a language.

Understanding the status of the power button and indicator light

Power button light	Printer status
Off	The printer is off, ready, or processing data.
White	The printer is in Sleep mode.

Non-touch Screen Model

Indicator light	Printer status
Off	The printer is off or in Sleep mode.
Green	The printer is on or ready.
Blinking green	The printer is processing data.
Blinking red	The printer requires user intervention.

Touch Screen Model

Indicator light	Printer status
Off	The printer is off or in Sleep mode.
Blue	The printer is on or ready.
Blinking blue	The printer is processing data.
Blinking red	The printer requires user intervention.

Selecting paper

Paper guidelines

Use the appropriate paper to prevent jams and help ensure trouble-free printing.

- Always use new, undamaged paper.
- Before loading paper, know the recommended printable side of the paper. This information is usually indicated on the paper package.
- Do not use paper that has been cut or trimmed by hand.
- Do not mix paper sizes, types, or weights in the same tray; mixing results in jams.
- Do not use coated papers unless they are specifically designed for electrophotographic printing.

Paper characteristics

The following paper characteristics affect print quality and reliability. Consider these factors before printing on them.

Weight

The tray can feed paper weights from 60 to 105g/m² (16 to 28 lb) grain long paper. Paper lighter than 60g/m² (16lb) may not be stiff enough to feed properly, and may cause jams.

Curl

Curl is the tendency for paper to curl at its edges. Excessive curl can cause paper feeding problems. Curl can occur after the paper passes through the printer, where it is exposed to high temperatures. Storing paper unwrapped in hot, humid, cold, or dry conditions can contribute to paper curling before printing and can cause feeding problems.

Smoothness

Paper smoothness directly affects print quality. If paper is too rough, toner cannot fuse to it properly. If paper is too smooth, it can cause paper feeding or print quality issues. We recommend the use of paper with 50 Sheffield points.

Moisture content

The amount of moisture in paper affects both print quality and the printer ability to feed the paper correctly. Leave paper in its original wrapper until you use it. Exposure of paper to moisture changes can degrade its performance.

Store paper in its original wrapper in the same environment as the printer for 24 to 48 hours before printing. Extend the time several days if the storage or transportation environment is very different from the printer environment. Thick paper may also require a longer conditioning period.

Grain direction

Grain refers to the alignment of the paper fibers in a sheet of paper. Grain is either *grain long*, running the length of the paper, or *grain short*, running the width of the paper.

For 60–105g/m² (16–28-lb) paper, grain long paper is recommended.

Fiber content

Most high-quality xerographic paper is made from 100 % chemically treated pulped wood. This content provides the paper with a high degree of stability, resulting in fewer paper feeding problems and better print quality. Paper containing fibers such as cotton can negatively affect paper handling.

Unacceptable paper

The following paper types are not recommended for use with the printer:

- Chemically treated papers used to make copies without carbon paper, also known as carbonless papers, carbonless copy paper (CCP), or no carbon required (NCR) paper
- Preprinted papers with chemicals that may contaminate the printer
- Preprinted papers that can be affected by the temperature in the printer fuser
- Preprinted papers that require a registration (the precise print location on the page) greater than ± 2.3 mm (± 0.9 in.), such as optical character recognition (OCR) forms

In some cases, registration can be adjusted with a software application to successfully print on these forms.

- Coated papers (erasable bond), synthetic papers, thermal papers
- Rough-edged, rough or heavily textured surface papers, or curled papers
- Recycled papers that fail EN12281:2002 (European)
- Paper weighing less than 60 g/m² (16 lb)
- Multiple-part forms or documents

Selecting preprinted forms and letterhead

- Use grain long paper.
- Use only forms and letterhead printed using an offset lithographic or engraved printing process.
- Avoid paper with rough or heavily textured surfaces.
- Use inks that are not affected by the resin in toner. Inks that are oxidation-set or oil-based generally meet these requirements; latex inks might not.
- Print samples on preprinted forms and letterheads considered for use before buying large quantities. This action determines whether the ink in the preprinted form or letterhead affects print quality.
- When in doubt, contact your paper supplier.
- When printing on letterhead, load the paper in the proper orientation for your printer. For more information, see the Paper and Specialty Media Guide.

Storing paper

Use these paper storage guidelines to help avoid jams and uneven print quality:

- Store paper in its original wrapper in the same environment as the printer for 24 to 48 hours before printing.
- Extend the time several days if the storage or transportation environment is very different from the printer environment. Thick paper may also require a longer conditioning period.
- For best results, store paper where the temperature is 21°C (70°F) and the relative humidity is 40 percent.
- Most label manufacturers recommend printing in a temperature range of 18–24°C (65–75°F) with relative humidity between 40 and 60 percent.
- Store paper in cartons, on a pallet or shelf, rather than on the floor.
- Store individual packages on a flat surface.
- Do not store anything on top of individual paper packages.
- Take paper out of the carton or wrapper only when you are ready to load it in the printer. The carton and wrapper help keep the paper clean, dry, and flat.

Supported paper sizes

- Paper less than 210 mm (8.3 in.) wide always prints at reduced speed.
- Use the manual feeder when printing on paper less than 105 mm (4.1 in.) wide.
- The minimum paper dimension supported for two-sided printing is 210 x 279.4 mm (8.3 x 11 in.).
- The maximum paper length supported by the scanner glass is 297 mm (11.7 in.).
- For two-sided printing on letter-, legal-, Oficio-, or folio-size paper, make sure that the paper size setting in the duplex unit is set to Letter.

Paper size	250-sheet tray	Manual feeder	Two-sided printing	Scanner glass	Automatic document feeder
A4 210 x 297 mm (8.27 x 11.7 in.)	✓	✓	✓	✓	✓
A5 (short edge feed) 148 x 210 mm (5.83 x 8.27 in.)	✓	✓	x	✓	✓
A5 (long edge feed) 210 x 148 mm (8.27 x 5.83 in.)	✓	✓	x	✓	✓

Paper size	250-sheet tray	Manual feeder	Two-sided printing	Scanner glass	Automatic document feeder
A6 105 x 148 mm (4.13 x 5.83 in.)	✓	✓	x	✓	✓
JIS B5 182 x 257 mm (7.17 x 10.1 in.)	✓	✓	x	✓	✓
Oficio (Mexico) 215.9 x 340.4 mm (8.5 x 13.4 in.)	✓	✓	✓	x	✓
Hagaki 100 x 148 mm (3.94 x 5.83 in.)	x	✓	x	✓	x
Statement 139.7 x 215.9 mm (5.5 x 8.5 in.)	✓	✓	x	✓	✓
Executive 184.2 x 266.7 mm (7.25 x 10.5 in.)	✓	✓	x	✓	✓
Letter 215.9 x 279.4 mm (8.5 x 11 in.)	✓	✓	✓	✓	✓
Legal 215.9 x 355.6 mm (8.5 x 14 in.)	✓	✓	✓	x	✓
Folio 215.9 x 330.2 mm (8.5 x 13 in.)	✓	✓	✓	x	✓
Universal 98 x 148 mm (3.9 x 5.8 in.) to 216 x 356 mm (8.5 x 14 in.)	x	✓	x	✓	✓

Paper size	250-sheet tray	Manual feeder	Two-sided printing	Scanner glass	Automatic document feeder
Universal 105 x 148 mm (4.1 x 5.8 in.) to 216 x 356 mm (8.5 x 14 in.)	✓	✓	X	✓	✓
7 3/4 Envelope (Monarch) 98.4 x 190.5 mm (3.875 x 7.5 in.)	X	✓	X	✓	X
9 Envelope 98.4 x 225.4 mm (3.875 x 8.9 in.)	X	✓	X	✓	X
10 Envelope 104.8 x 241.3 mm (4.12 x 9.5 in.)	X	✓	X	✓	X
DL Envelope 110 x 220 mm (4.33 x 8.66 in.)	X	✓	X	✓	X
C5 Envelope 162 x 229 mm (6.38 x 9.01 in.)	X	✓	X	✓	X
B5 Envelope 176 x 250 mm (6.93 x 9.84 in.)	X	✓	X	✓	X
Universal Envelope 98.4 x 162 mm (3.87 x 6.38 in.) to 176 x 250 mm (6.93 x 9.84 in.)	X	✓	X	✓	X

Supported paper types



Note: Labels, envelopes, and card stock always print at reduced speed.

Paper type	250-sheet tray	Manual feeder	Two-sided printing	Automatic document feeder
Plain paper	✓	✓	✓	✓
Card stock	X	✓	X	X
Labels	X	✓	X	X
Bond	✓	✓	✓	✓
Envelope	X	✓	X	X
Letterhead	✓	✓	✓	✓
Preprinted	✓	✓	✓	✓
Colored paper	✓	✓	✓	✓
Light	✓	✓	✓	✓
Heavy	✓	✓	✓	✓
Recycled	✓	✓	✓	✓

Supported paper weights

250-sheet tray	Manual feeder	Two-sided printing	Automatic document feeder
60–105g/m ² (16–28-lb bond)	60–200g/m ² (16–54-lb bond)	60–105g/m ² (16–28-lb bond)	60–105g/m ² (16–28-lb bond)

Learn about the printer

Set up, install, and configure

This chapter contains:

- [Selecting a location for the printer](#) 34
- [Attaching cables](#) 36
- [Finding the IP Address of the Printer](#) 38
- [Setting up the printer to fax](#)..... 39
- [Configuring the Email SMTP Settings](#) 45
- [Loading paper and specialty media](#)..... 54
- [Installing and updating software, drivers, and firmware](#) 57
- [Networking](#) 62
- [Printing the Menu Settings Page](#) 66

Selecting a location for the printer

- Leave enough room to open trays, covers, and doors and to install hardware options.
- Set up the printer near an electrical outlet.
- **Warning:** To avoid the risk of fire or electrical shock, connect the power cord to an appropriately rated and properly grounded electrical outlet that is near the product and easily accessible.
- **CAUTION—SHOCK HAZARD:** To avoid the risk of electrical shock, do not place or use this product near water or wet locations.
- Make sure that airflow in the room meets the latest revision of the ASHRAE 62 standard or the CEN Technical Committee 156 standard.
- Provide a flat, sturdy, and stable surface.
- Keep the printer:
 - Clean, dry, and free of dust
 - Away from stray staples and paper clips
 - Away from the direct airflow of air conditioners, heaters, or ventilators
 - Free from direct sunlight and humidity extremes
- Observe the recommended temperatures and avoid fluctuations.
 - Ambient temperature: 10 to 32.2°C (50 to 90°F)
 - Storage temperature: -40 to 43.3°C (-40 to 110°F)
- Allow the following recommended amount of space around the printer for proper ventilation:

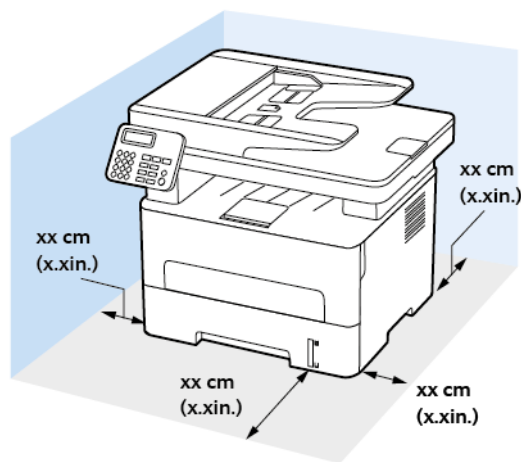





1. Top: 360 mm (14 in.)
2. Rear: 260 mm (10 in.)
3. Right side: 200 mm (8 in.)

4. Front: 550 mm (22 in.)

The minimum space needed in front of the printer is 76 mm (3 in.).

5. Left side: 200 mm (8 in.)

Attaching cables

-  **CAUTION—SHOCK HAZARD:** To avoid the risk of electrical shock, do not set up this product or make any electrical or cabling connections, such as the power cord, fax feature, or telephone, during a lightning storm.
-  **CAUTION—POTENTIAL INJURY:** To avoid the risk of fire or electrical shock, connect the power cord to an appropriately rated and properly grounded electrical outlet that is near the product and easily accessible.
-  **CAUTION—POTENTIAL INJURY:** To avoid the risk of fire or electrical shock, use only the power cord provided with this product or the manufacturer's authorized replacement.
-  **CAUTION—POTENTIAL INJURY:** To reduce the risk of fire, use only a 26 AWG or larger telecommunications (RJ-11) cord when connecting this product to the public switched telephone network. For users in Australia, the cord must be approved by the Australian Communications and Media Authority.
-  **Warning:** To avoid loss of data or printer malfunction, do not touch the USB cable, any wireless network adapter, or the printer in the areas shown while actively printing.

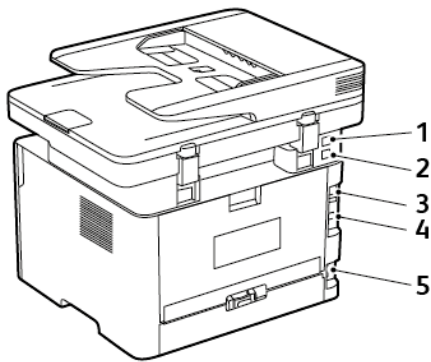

Number	Printer port	Function
1	EXT port	Connect more devices (telephone or answering machine) to the printer and the telephone line. Use this port if you do not have a dedicated fax line for the printer and if this connection method is supported in your country or region.
2	LINE port	Connect the printer to an active telephone line through a standard wall jack (RJ-11), DSL filter, or VoIP adapter, or any other adapter that allows you to access the telephone line to send and receive faxes.
3	Ethernet port	Connect the printer to a network.

Number	Printer port	Function
4	USB printer port	Connect the printer to a computer.
5	Power cord socket	Connect the printer to a properly grounded electrical outlet.

Set up, install, and configure

Finding the IP Address of the Printer

To view the IP address of the printer, open the Home Screen. The IP address appears as four sets of numbers separated by periods, such as 123.123.123.123.

If you are using a proxy server, temporarily disable it to load the Web page correctly.

Setting up the printer to fax

Setting up the fax function

- Some connection methods are applicable only in some countries or regions.
- If the fax function is enabled and not fully set up, then the indicator light may blink red.
- If you do not have a TCP/IP environment, then use the control panel to set up fax.

 **Warning:** To avoid loss of data or printer malfunction, do not touch cables or the printer in the area shown while actively sending or receiving a fax.



Using the fax setup wizard in the printer

- The setup wizard is available only if analog fax is not set up.
 - This wizard only sets up the analog fax. To setup other fax modes, go to **Settings > Fax > Fax Setup**.
 - These instructions apply only to some printer models.
 - Before using the wizard, make sure that the printer firmware is updated. For more information, see [Using the fax setup wizard in the printer](#).
1. From the home screen, touch **Fax**.
 2. Touch **Set up now**.
 3. Type the fax name, and then touch **Next**.
 4. Enter the fax number and then touch **Done**.

Using the Settings menu in the printer

1. From the control panel, navigate to:
Settings > Fax > Fax Setup > General Fax settings
For non-touch-screen printer models, press **OK** to navigate through the settings.
2. Configure the settings.

Using the Embedded Web Server

1. Open a web browser, and then type the printer IP address in the address field.
 - View the printer IP address on the home screen. The IP address appears as four sets of numbers separated by periods, such as 123.123.123.123.
 - If you are using a proxy server, then temporarily disable it to load the web page correctly.
2. Click **Settings** > **Fax** > **Fax Setup** > **General Fax Settings**.
3. Configure the settings.
4. Apply the changes.

Setting up fax using a standard telephone line

- ⚠ **CAUTION—SHOCK HAZARD:** To avoid the risk of electrical shock, do not set up this product or make any electrical or cabling connections, such as the power cord, fax feature, or telephone, during a lightning storm.
- ⚠ **CAUTION—SHOCK HAZARD:** To avoid the risk of electrical shock, do not use the fax feature during a lightning storm.
- ⚠ **CAUTION—POTENTIAL INJURY:** To reduce the risk of fire, use only a 26 AWG or larger telecommunications (RJ-11) cord when connecting this product to the public switched telephone network. For users in Australia, the cord must be approved by the Australian Communications and Media Authority.

Setup 1: Printer is connected to a dedicated fax line

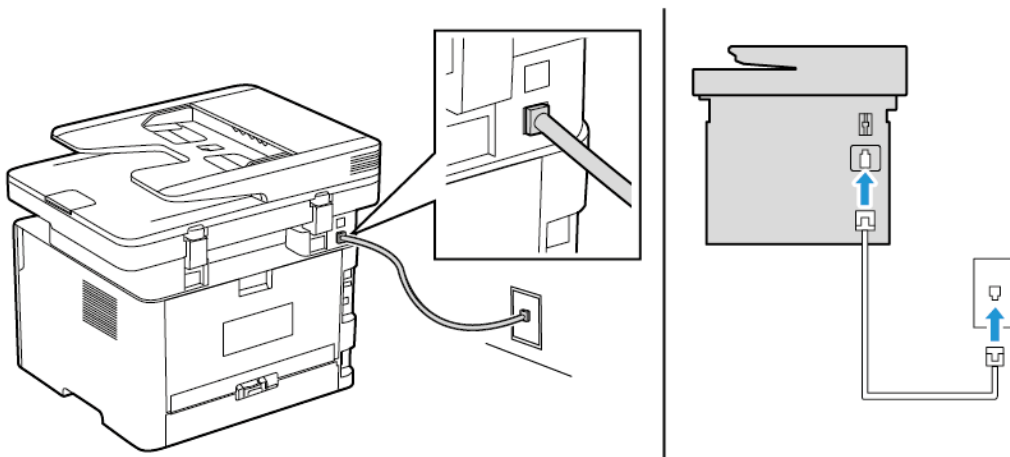

1. Connect one end of the telephone cable to the line port of the printer.
2. Connect the other end of the cable to an active analog wall jack.
 - You can set the printer to receive faxes automatically (set Auto Answer to **On**) or manually (set Auto Answer to **Off**).
 - If you want to receive faxes automatically, then set the printer to pick up on a specified number of rings.

Setup 2: Printer is sharing the line with an answering machine

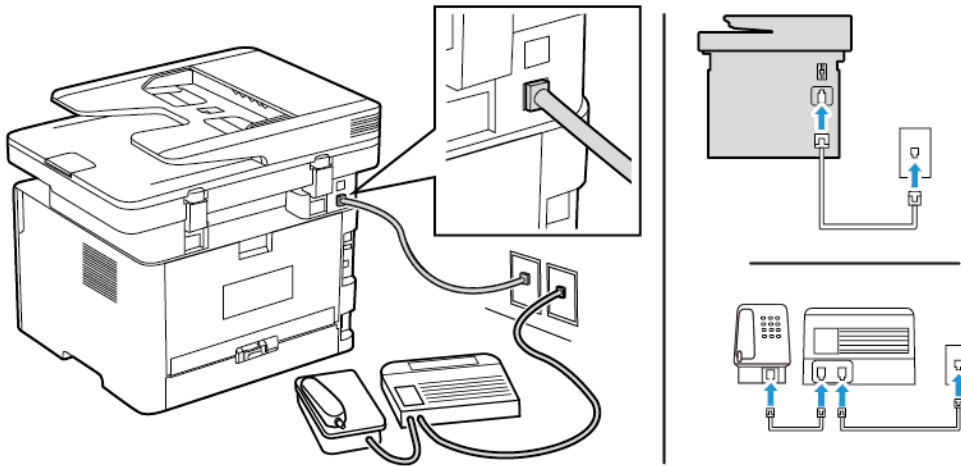

 **Note:** If you subscribe to a distinctive ring service, then make sure that you set the correct ring pattern for the printer. Otherwise, the printer does not receive faxes even if you have set it to receive faxes automatically.

Connected to different wall jacks



1. Connect one end of the telephone cable to the line port of the printer.
 2. Connect the other end of the cable to an active analog wall jack.
- If you have only one telephone number on your line, then set the printer to receive faxes automatically.
 - Set the printer to pick up calls two rings after the answering machine. For example, if the answering machine picks up calls after four rings, then set the printer Rings to Answer setting to 6.

Setting Up Fax in Countries or Regions with Different Telephone Wall Jacks and Plugs

-  **CAUTION—SHOCK HAZARD:** To avoid the risk of electrical shock, do not set up this product or make any electrical or cabling connections, such as the power cord, fax feature, or telephone, during a lightning storm.
-  **CAUTION—SHOCK HAZARD:** To avoid the risk of electrical shock, do not use the fax feature during a lightning storm.
-  **Warning:** To reduce the risk of fire, use only a 26 AWG or larger telecommunications (RJ-11) cord when connecting this product to the public switched telephone network. For users in Australia, the cord must be approved by the Australian Communications and Media Authority.

The standard wall jack adopted by most countries or regions is RJ11. If the wall jack or equipment in your facility is not compatible with this type of connection, then use a telephone adapter. An adapter for your country or region may not come with your printer, and you may need to purchase it separately.

There may be an adapter plug installed in the telephone port of the printer. Do not remove the

Set up, install, and configure

adapter plug from the telephone port of the printer if you are connecting to a serial or cascaded telephone system.

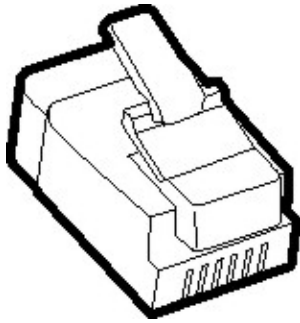

Connecting the printer to a non-RJ11 wall jack

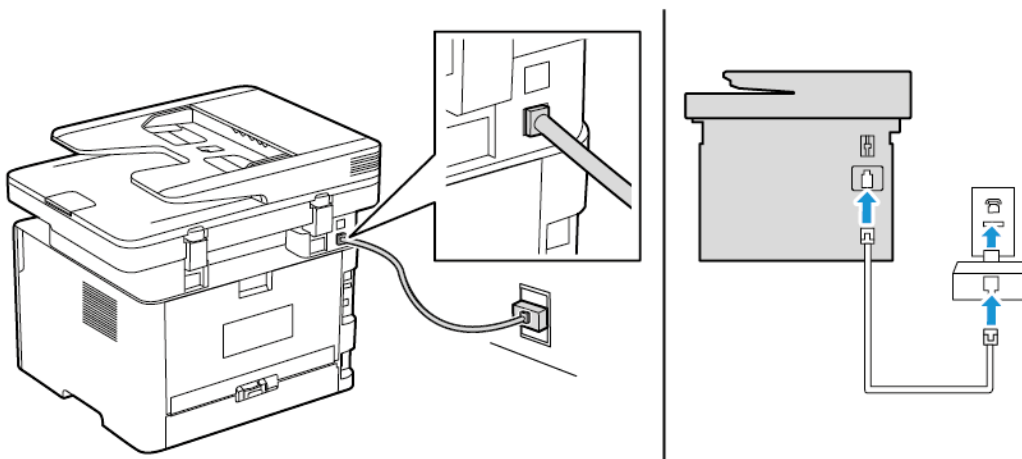

1. Connect one end of the telephone cable to the line port of the printer.
2. Connect the other end of the cable to the RJ11 adapter, and then connect the adapter to the wall jack.
3. If you want to connect another device with a non-RJ11 connector to the same wall jack, then connect it directly to the telephone adapter.

Connecting the printer to a wall jack in Germany

The German wall jack has two kinds of ports. The N ports are for fax machines, modems, and answering machines. The F port is for telephones. Connect the printer to any of the N ports.

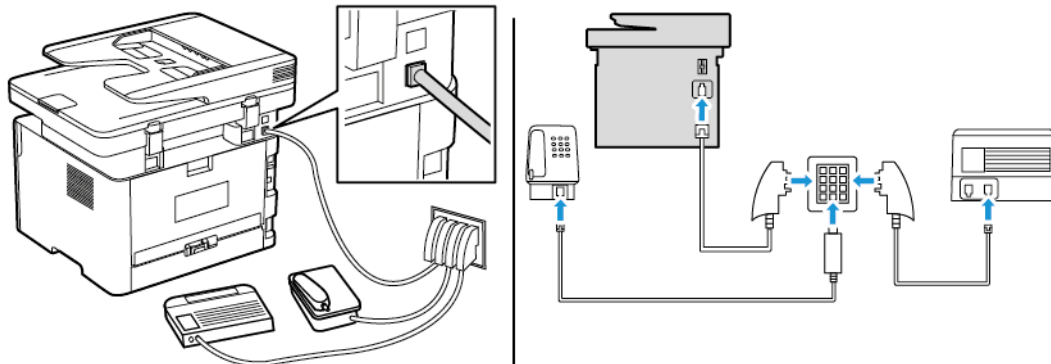

1. Connect one end of the telephone cable to the line port of the printer.
2. Connect the other end of the cable to the RJ11 adapter, and then connect the adapter to an N port.
3. If you want to connect a telephone and answering machine to the same wall jack, then connect the devices as shown.

Connecting to a distinctive ring service

A distinctive ring service lets you have multiple telephone numbers on one telephone line. Each telephone number is assigned a different ring pattern.

1. From the control panel, navigate to:
Settings > Fax > Fax Setup > Fax Receive Settings > Admin Controls > Answer On
 For non-touch-screen printer models, press **OK** to navigate through the settings.
2. Select a ring pattern.
3. Apply the changes.

Setting the fax date and time

1. From the control panel, navigate to:
Settings > Device > Preferences > Date and Time > Configure
 For non-touch-screen printer models, press **OK** to navigate through the settings.
2. Configure the settings.

Configuring daylight saving time

1. From the home screen, navigate to **Settings > Device > Preferences > Date and Time > Configure**.

For non-touch-screen printer models, press **OK** to navigate through the settings.

2. In the Time Zone menu, select **(UTC+user) Custom**.
3. In the UTC Offset menu, set the daylight saving time offset.

Configuring the fax speaker settings

1. From the control panel, navigate to:
Settings > Fax > Fax Setup > Speaker Settings

For non-touch-screen printer models, press **OK** to navigate through the settings.

2. Do the following:
 - Set Speaker Mode to **Always On**.
 - Set Speaker Volume to **High**.
 - Enable Ringer Volume.

Configuring the Email SMTP Settings

Configure the Simple Mail Transfer Protocol (SMTP) settings to send a scanned document through e-mail. The settings vary with each service provider. For more information, refer to [Email Service Providers](#).

Before you begin, make sure that the printer is connected to a network and that the network is connected to the Internet.

Using the Email Setup Wizard in the Printer

- Before using the wizard, make sure that the printer firmware is updated. For more information, see [Updating Firmware](#).
 - For non-touch-screen printer models, press **OK** to navigate through the settings.
1. From the home screen, touch **E-mail**.
 2. Touch **Set up now**, and then type your e-mail address.
 3. Type the password.
 - Depending on your e-mail service provider, type your account password, app password, or authentication password. For more information on the password, refer to [Email Service Providers](#), and then look for Device Password.
 - If your provider is not listed, then contact your provider and ask for the Primary SMTP Gateway, Primary SMTP Gateway Port, Use SSL/TLS, and SMTP Server Authentication settings.
 4. Touch **OK**.

Using the Settings Menu in the Printer

1. From the home screen, touch **Settings > E-mail > E-mail Setup**.
2. Configure the settings.
 - For more information on the password, refer to [Email Service Providers](#).
 - For e-mail service providers that are not on the list, contact your provider and ask for the settings.
 - For non-touch-screen printer models, press **OK** to navigate through the settings.

Using the Embedded Web Server

1. Open a web browser, and then type the printer IP address in the address field.
 - a. To view the printer IP address, go to the printer home screen. The IP address appears as four sets of numbers separated by periods, such as 123.123.123.123.
 - b. If you are using a proxy server, then temporarily disable it to load the web page correctly.
2. Click **Settings > E-mail**.
3. From the E-mail Setup section, configure the settings.

Set up, install, and configure

4. Click **Save**.
 - a. For more information on the password, refer to [Email Service Providers](#).
 - b. For e-mail service providers that are not on the list, contact your provider and ask for the settings.

Email Service Providers

To determine the SMTP settings of your email service provider, use the following tables.

Gmail™

 **Note:** Make sure that two-step verification is enabled on your Google account.

To enable two-step verification, go to the [Google Account Security](#) page, log in to your account, then from the Signing in to Google section, click **2-Step Verification**.

Setting	Value
Primary SMTP Gateway	smtp.gmail.com
Primary SMTP Gateway Port	587
Use SSL/TLS	Required
Require Trusted Certificate	Disabled
Reply Address	Your email address
SMTP Server Authentication	Login/Plain
Device-Initiated E-mail	Use Device SMTP Credentials
Device UserID	Your email address
Device Password	App password  Note: To create an app password, go to the Google Account Security page, log in to your account, and from the Signing in to Google section, click App passwords .

Yahoo!® Mail

Setting	Value
Primary SMTP Gateway	smtp.mail.yahoo.com
Primary SMTP Gateway Port	587
Use SSL/TLS	Required
Require Trusted Certificate	Disabled
Reply Address	Your email address

Setting	Value
SMTP Server Authentication	Login/Plain
Device-Initiated E-mail	Use Device SMTP Credentials
Device UserID	Your email address
Device Password	App password  Note: To create an app password, go to the Yahoo Account Security page, log in to your account, and then click Generate app password

Outlook Live

These settings apply to outlook.com and hotmail.com email domains.

Setting	Value
Primary SMTP Gateway	smtp.office365.com
Primary SMTP Gateway Port	587
Use SSL/TLS	Required
Require Trusted Certificate	Disabled
Reply Address	Your email address
SMTP Server Authentication	Login/Plain
Device-Initiated E-mail	Use Device SMTP Credentials
Device UserID	Your email address
Device Password	Account password or app password <ul style="list-style-type: none"> For accounts with two-step verification disabled, use your account password. For accounts with two-step verification enabled, use an app password. To create an app password, go to the Outlook Live Account Management page, then log in to your account.

AOL Mail

Setting	Value
Primary SMTP Gateway	smtp.aol.com
Primary SMTP Gateway Port	587
Use SSL/TLS	Required
Require Trusted Certificate	Disabled
Reply Address	Your email address

Set up, install, and configure

Setting	Value
SMTP Server Authentication	Login/Plain
Device-Initiated E-mail	Use Device SMTP Credentials
Device UserID	Your email address
Device Password	App password  Note: To create an app password, go to the AOL Account Security page, log in to your account, then click Generate app password .

iCloud Mail

 **Note:** Make sure that the two-step verification is enabled on your account.

Setting	Value
Primary SMTP Gateway	smtp.mail.me.com
Primary SMTP Gateway Port	587
Use SSL/TLS	Required
Require Trusted Certificate	Disabled
Reply Address	Your email address
SMTP Server Authentication	Login/Plain
Device-Initiated E-mail	Use Device SMTP Credentials
Device UserID	Your email address
Device Password	App password  Note: To create an app password, go to the iCloud Account Management page, log in to your account, then from the Security section, click Generate Password .

Comcast Mail

Setting	Value
Primary SMTP Gateway	smtp.comcast.net
Primary SMTP Gateway Port	587
Use SSL/TLS	Required
Require Trusted Certificate	Disabled
Reply Address	Your email address
SMTP Server Authentication	Login/Plain

Setting	Value
Device-Initiated Email	Use Device SMTP Credentials
Device UserID	Your email address
Device Password	Account password

Mail.com

Setting	Value
Primary SMTP Gateway	smtp.mail.com
Primary SMTP Gateway Port	587
Use SSL/TLS	Required
Require Trusted Certificate	Disabled
Reply Address	Your email address
SMTP Server Authentication	Login/Plain
Device-Initiated E-mail	Use Device SMTP Credentials
Device UserID	Your email address
Device Password	Account password

Zoho Mail

Setting	Value
Primary SMTP Gateway	smtp.zoho.com
Primary SMTP Gateway Port	587
Use SSL/TLS	Required
Require Trusted Certificate	Disabled
Reply Address	Your email address
SMTP Server Authentication	Login/Plain
Device-Initiated E-mail	Use Device SMTP Credentials

Setting	Value
Device UserID	Your email address
Device Password	<p>Account password or app password</p> <ul style="list-style-type: none"> For accounts with two-step verification disabled, use your account password. For accounts with two-step verification enabled, use an app password. To create an app password, go to the Zoho Mail Account Security page, log in to your account, then from the Application-Specific Passwords section, click Generate New Password.

QQ Mail

 **Note:** Make sure that the SMTP service is enabled on your account.

To enable the service, from the QQ Mail home page, click **Settings > Account**, then from the POP3/IMAP/SMTP/Exchange/CardDAV/CalDAV Service section, enable either **POP3/SMTP service** or **IMAP/SMTP service**.

Setting	Value
Primary SMTP Gateway	smtp.qq.com
Primary SMTP Gateway Port	587
Use SSL/TLS	Required
Require Trusted Certificate	Disabled
Reply Address	Your email address
SMTP Server Authentication	Login/Plain
Device-Initiated E-mail	Use Device SMTP Credentials
Device UserID	Your email address
Device Password	<p>Authorization code</p> <p> Note: To generate an authorization code, from the QQ Mail home page, click Settings > Account, then from the POP3/IMAP/SMTP/Exchange/CardDAV/CalDAV Service section, click Generate authorization code</p>

NetEase Mail (mail.163.com)

 **Note:** Make sure that the SMTP service is enabled on your account.

To enable the service, from the NetEase Mail home page, click **Settings > POP3/SMTP/IMAP**, and then enable either **IMAP/SMTP service** or **POP3/SMTP service**.

Setting	Value
Primary SMTP Gateway	smtp.163.com
Primary SMTP Gateway Port	465
Use SSL/TLS	Required
Require Trusted Certificate	Disabled
Reply Address	Your email address
SMTP Server Authentication	Login/Plain
Device-Initiated Email	Use Device SMTP Credentials
Device UserID	Your email address
Device Password	Authorization password
	 Note: The authorization password is provided when IMAP/SMTP service or POP3/SMTP service is enabled.

NetEase Mail (mail.126.com)

 **Note:** Make sure that the SMTP service is enabled on your account.

To enable the service, from the NetEase Mail home page, click **Settings > POP3/SMTP/IMAP**, then enable either **IMAP/SMTP service** or **POP3/SMTP service**.

Setting	Value
Primary SMTP Gateway	smtp.126.com
Primary SMTP Gateway Port	465
Use SSL/TLS	Required
Require Trusted Certificate	Disabled
Reply Address	Your email address
SMTP Server Authentication	Login/Plain
Device-Initiated Email	Use Device SMTP Credentials
Device UserID	Your email address
Device Password	Authorization password
	 Note: The authorization password is provided when IMAP/SMTP service or POP3/SMTP service is enabled.

NetEase Mail (mail.yeah.net)

 **Note:** Make sure that the SMTP service is enabled on your account.

Set up, install, and configure

To enable the service, from the NetEase Mail home page, click **Settings > POP3/SMTP/IMAP**, and then enable either **IMAP/SMTP service** or **POP3/SMTP service**.

Setting	Value
Primary SMTP Gateway	smtp.yeah.net
Primary SMTP Gateway Port	465
Use SSL/TLS	Required
Require Trusted Certificate	Disabled
Reply Address	Your email address
SMTP Server Authentication	Login/Plain
Device-Initiated Email	Use Device SMTP Credentials
Device UserID	Your email address
Device Password	Authorization password
	 Note: The authorization password is provided when IMAP/SMTP service or POP3/SMTP service is enabled.

Sohu Mail

 **Note:** Make sure that the SMTP service is enabled on your account.

To enable the service, from the Sohu Mail home page, click **Options > Settings > POP3/SMTP/IMAP**, and then enable either **IMAP/SMTP service** or **POP3/SMTP service**.

Setting	Value
Primary SMTP Gateway	smtp.sohu.com
Primary SMTP Gateway Port	465
Use SSL/TLS	Required
Require Trusted Certificate	Disabled
Reply Address	Your email address
SMTP Server Authentication	Login/Plain
Device-Initiated Email	Use Device SMTP Credentials
Device UserID	Your email address
Device Password	Independent password
	 Note: The independent password is provided when IMAP/SMTP service or POP3/SMTP service is enabled.

Sina Mail



Note: Make sure that the POP3/SMTP service is enabled on your account.

To enable the service, from the Sina Mail home page, click **Settings > More settings > User-end POP/IMAP/SMTP**, and then enable **POP3/SMTP service**.

Setting	Value
Primary SMTP Gateway	smtp.sina.com
Primary SMTP Gateway Port	587
Use SSL/TLS	Required
Require Trusted Certificate	Disabled
Reply Address	Your email address
SMTP Server Authentication	Login/Plain
Device-Initiated Email	Use Device SMTP Credentials
Device UserID	Your email address
Device Password	Authorization code  Note: To create an authorization code, from the email home page, click Settings > More settings > User-end POP/IMAP/SMTP , and then enable Authorization code status .

- If you encounter errors using the settings provided, then contact your email service provider.
- For email service providers that are not on the list, contact your provider and ask for the settings.

Loading paper and specialty media

Setting the Paper Size and Type

1. From the control panel, navigate to **Settings****PaperTray Configuration****Paper Size/Type**, then select a paper source.
For non-touch-screen printer models, to navigate through the settings, press **OK**.
2. Set the paper size and type.
 - For two-sided printing on A4-size paper, make sure that the paper size setting in the duplex unit is set to A4.
 - For two-sided printing on letter-, legal-, Oficio-, or folio-size paper, make sure that the paper size setting in the duplex unit is set to Letter.

Configuring Universal paper settings

1. From the control panel, navigate to:
Settings > Paper > Media Configuration > Universal Setup
For non-touch-screen printer models, press **OK** to navigate through the settings.
2. Configure the settings.

Loading the Tray

1. Remove the tray.

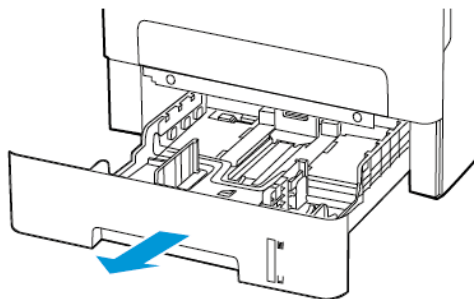

2. Adjust the paper guides to match the size of the paper that you are loading.

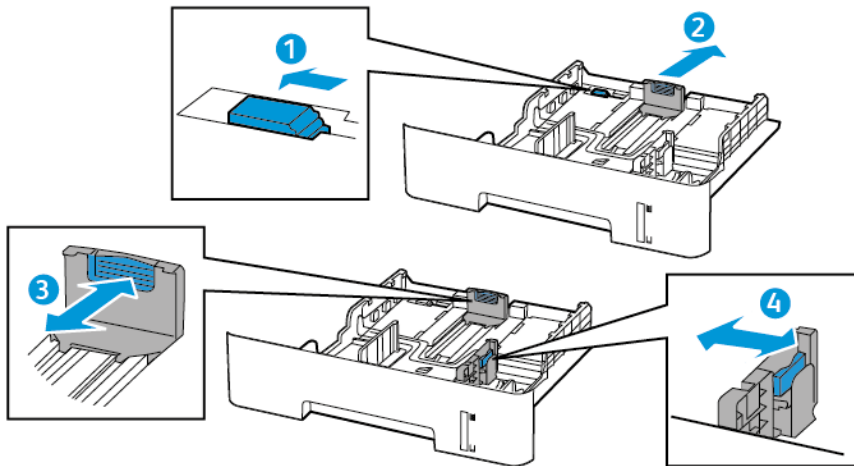

3. Flex, fan, and align the paper edges before loading.



4. Load the paper stack with the printable side facedown, and then make sure that the side guides fit snugly against the paper.

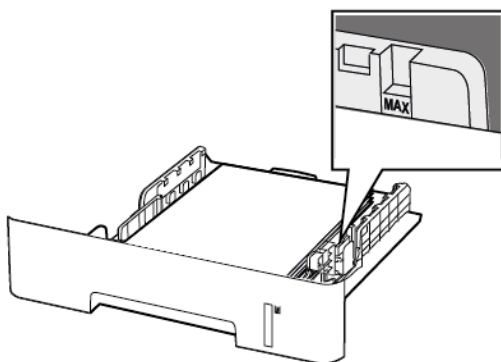

- Load letterhead facedown with the top edge of the sheet toward the front of the tray for one-sided printing.
- Load letterhead faceup with the bottom edge of the sheet toward the front of the tray for two-sided printing.
- Do not slide paper into the tray.
- To avoid paper jams, make sure that the stack height is below the maximum paper fill indicator.

Set up, install, and configure

5. Insert the tray.

If necessary, set the paper size and paper type from the control panel to match the paper loaded.

Loading the Manual Feeder

1. Open the manual feeder.

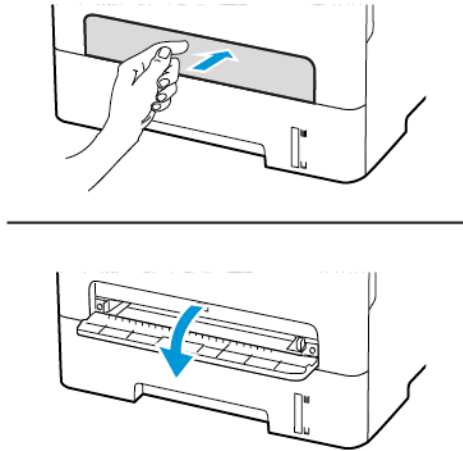

2. Adjust the guide to match the size of the paper that you are loading.

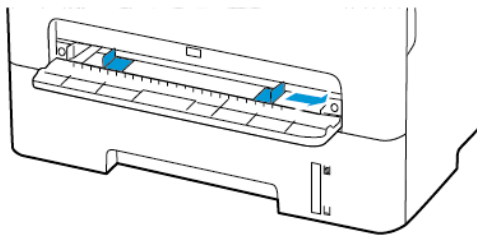

3. Load a sheet of paper with the printable side faceup.

- Load letterhead with the printable side faceup and the top edge entering the printer first for one-sided printing.
- Load letterhead with the printable side facedown and the top edge entering the printer last for two-sided printing.
- Load envelope with the flap side down and against the left side of the paper guide.



Warning: To avoid paper jams, do not force paper into the manual feeder.

Installing and updating software, drivers, and firmware

Installing the Software

Before you install the print driver software, verify that the printer is plugged in, powered on, connected correctly, and has a valid IP address. The IP address usually appears in the upper right corner of the control panel.

To view the IP address of the printer, refer to [Finding the IP Address of the Printer](#).



Note: If the *Software and Documentation disc* is not available, download the latest drivers from www.xerox.com/drivers

Operating System Requirements

- Windows 7, Windows 8, Windows 8.1, Windows 10, Windows Server 2008 R2, Windows Server 2012, Windows Server 2016, and Windows Server 2019.
- MacOS version 10.14 and later.
- UNIX and Linux: Your printer supports connection to various UNIX platforms through the network interface.

Installing the Print Drivers for a Windows Network Printer

1. Insert the *Software and Documentation disc* into the appropriate drive on your computer. If the installer does not start automatically, navigate to the drive, then double-click the **Setup.exe** installer file.
2. Click **Xerox Smart Start — Driver Installer (Recommended)**.
3. At the License Agreement, click **Agree**.
4. From the list of discovered printers, select your printer.
When you install print drivers for a network printer, if your printer does not appear in the list, click **Don't See Your Printer?**, then enter the IP address for your printer.

To view the IP address of your printer, refer to [Finding the IP Address of the Printer](#).

5. Click **Quick Install**.
A message appears that confirms that the installation is successful.
6. To complete the installation and close the Installer window, click **Done**.

Installing the Windows Print Driver .zip File

You can download print drivers from Xerox.com in a .zip file, then use the Windows Add Printer Wizard to install the print drivers on your computer.

To install the print driver from the .zip file:

1. Download, then extract the required .zip file to a local directory on your computer.

Set up, install, and configure

2. At your computer, open the **Control Panel**, then select **Devices and Printers > Add a Printer**.
3. Click **The printer that I want isn't listed**, then click **Add a local printer or network printer with manual settings**.
4. To use a previously established port, select **Use an existing port**, then from the list, select a Standard TCP/IP Port.
5. To create a Standard TCP/IP port:
 - a. Select **Create a New Port**.
 - b. For Type of port, select **Standard TCP/IP Port**, then click **Next**.
 - c. In the Hostname or IP address field, type the printer IP address or host name.
 - d. To disable the feature, clear the check box for **Query the printer and automatically select the driver to use**, then click **Next**.
6. Click **Have Disk**.
7. Click **Browse**. Browse to, then select the driver.inf file for your printer. Click **Open**.
8. Select your printer model, then click **Next**.
9. If a prompt appears because the print driver was installed previously, click **Use the driver that is currently installed (recommended)**.
10. In the Printer name field, type a name for your printer.
11. To install the print driver, click **Next**.
12. If needed, set the printer as the default printer.



Note: Before you select **Share Printer**, contact your system administrator.

13. To send a test page to the printer, click **Print a test page**.
14. Click **Finish**.

Installing the Print Drivers for a Windows USB Printer

1. Connect the B end of a standard A/B USB 2.0 or USB 3.0 cable to the USB Port on the back of the printer.
2. Connect the A end of the USB cable to the USB port on the computer.
3. If the Windows Found New Hardware Wizard appears, click **cancel**.
4. Insert the *Software and Documentation disc* into the appropriate drive on your computer. If the installer does not start automatically, navigate to the drive, then double-click the **Setup.exe** installer file.
5. Click **Xerox Smart Start — Driver Installer (Recommended)**.
6. At the License Agreement, click **Agree**.
7. From the list of discovered printers, select your printer, then click **Quick Install**.
A message appears that confirms that the installation is successful.
8. To complete the installation and close the Installer window, click **Done**.

Installing the Printer as a Web Service on Devices

Web Services on Devices (WSD) allows a client to discover and access a remote device and its associated services across a network. WSD supports device discovery, control, and use.

Installing a WSD Printer Using the Add Device Wizard

1. At your computer, click **Start**, then select **Printers and Scanners**.
2. To add the required printer, click **Add a Printer or Scanner**.
3. In the list of available devices, select the device that you want to use, then click **Next**.



Note: If the printer that you want to use does not appear in the list, click **Cancel**. To add the printer manually, use the IP address of the printer. For details, refer to [Installing the Windows Print Driver .zip File](#).

4. Click **Close**.

Installing the Drivers and Utilities for MacOS

1. Download the latest print driver from <https://www.xerox.com/office/drivers>.
2. Open the Xerox® Print Drivers 5.xx.x.dmg or .pkg as needed for your printer.
3. To run Xerox® Print Drivers 5.xx.x.dmg or .pkg, double-click the appropriate file name.
4. When prompted, click **Continue**.
5. To accept the license agreement, click **I Agree**.
6. To accept the current installation location, click **Install**, or select another location for the installation files, then click **Install**.
7. If prompted, enter your password, then click **OK**.
8. From the list of discovered printers, select your printer, then click **Next**.
9. If your printer does not appear in the list of discovered printers:
 - a. Click the **Network Printer Icon**.
 - b. Type the IP address of your printer, then click **Continue**.
 - c. Select your printer in the list of discovered printers, then click **Continue**.
10. If your printer was not detected, verify that the printer is powered on and that the Ethernet or USB cable is connected properly.
11. To accept the print queue message, click **OK**.
12. Select or clear the **Set Printer as Default** and **Print a Test Page** check boxes.
13. Click **Continue**, then click **Close**.

Adding the Printer for MacOS

For networking, set up your printer using Bonjour® (mDNS), or for an LPD, LPR connection, connect using the IP address of your printer. For a non-network printer, create a desktop USB connection.

For more information, go to the Online Support Assistant at: <https://www.xerox.com/support>.

Set up, install, and configure

Adding the Printer Using Bonjour

To add the printer using Bonjour®:

1. From the computer Applications folder or from the dock, open **System Preferences**.
2. Click **Printers & Scanners**.
The list of printers appears on the left of the window.
3. For the list of printers, click the Plus icon (+).
4. At the top of the window, click the **Default** icon.
5. Select your printer from the list, then click **Add**.

 **Note:** If your printer is not detected, verify that the printer is powered on and that the Ethernet cable is connected properly.

Adding the Printer by Specifying the IP Address

To add the printer by specifying the IP address:

1. From the computer Applications folder or from the dock, open **System Preferences**.
2. Click **Printers & Scanners**.
The list of printers appears on the left of the window.
3. In the list of printers, click the Plus (+) icon.
4. Click **IP**.
5. From the Protocol list, select the protocol.
6. In the Address field, enter the IP address of the printer.
7. In the Name field, enter a name for the printer.
8. From the Use list, choose **Select a driver to use**.
9. From the printer software list, select the print driver for your printer model.
10. Click **Add**.

Installing Print Drivers and Utilities for UNIX and Linux

For more information on installing print drivers and utilities for UNIX and Linux, refer to <https://www.xerox.com/office/drivers>.

Updating Firmware

Some applications require a minimum device firmware level to operate correctly.

For more information on updating the device firmware, contact your customer service representative.

1. Open a web browser, and then type the printer IP address in the address field.
 - View the printer IP address on the printer home screen. The IP address appears as four sets of numbers separated by periods, such as 123.123.123.123.
 - If you are using a proxy server, then temporarily disable it to load the web page correctly.

2. Click **Settings > Device > Update Firmware**.
 3. Choose one of the following:
 - Click **Check for updates > I agree, start update**.
 - Upload the flash file. To upload the flash file, perform the following steps. To get the latest firmware, go to www.xerox.com, and search for your printer model.
 1. Browse to the flash file.
-  **Note:** Make sure that you have extracted the firmware zip file.
2. Click **Upload > Start**.

Exporting or importing a configuration file

You can export the configuration settings of your printer into a text file, and then import the file to apply the settings to other printers.

1. Open a web browser, and then type the printer IP address in the address field.
 - View the printer IP address on the printer home screen. The IP address appears as four sets of numbers separated by periods, such as 123.123.123.123.
 - If you are using a proxy server, then temporarily disable it to load the web page correctly.
2. From the Embedded Web Server, click **Export Configuration** or **Import Configuration**.
3. Follow the instructions on the screen.
4. If the printer supports applications, then do the following:
 - a. Click **Apps > select the application > Configure**.
 - b. Click **Export** or **Import**.

Networking

Connecting the Printer to a Wi-Fi Network

Before you begin, make sure that:

- Active Adapter is set to Auto. From the control panel, navigate to **Settings > Network/Ports > Network Overview > Active Adapter**.

For non-touch-screen printer models, press **OK** to navigate through the settings.

- The Ethernet cable is not connected to the printer.

Using the Wireless Setup Wizard in the Printer

- These instructions apply only to some printer models.
 - Before using the wizard, make sure that the printer firmware is updated. For more information, see [Updating Firmware](#).
1. From the home screen, touch **Wi-Fi** icon, then touch **Set up now**.
 2. Select a Wi-Fi network, and then type the network password.
 3. Touch **Done**.

Using the Settings Menu in the Printer

1. From the control panel, navigate to:
Settings > Network/Ports > Wireless > Setup On Printer Panel

For non-touch-screen printer models, press **OK** to navigate through the settings.

2. Select a Wi-Fi network, and then type the network password.

 **Note:** For Wi-Fi-network-ready printer models, a prompt to set up the Wi-Fi network appears during initial setup.

Connecting the printer to a wireless network using Wi-Fi Protected Setup (WPS)

Before you begin, make sure that:

- The access point (wireless router) is WPS-certified or WPS-compatible. For more information, see the documentation that came with your access point.
- A wireless network adapter is installed in your printer. For more information, see the instructions that came with the adapter.
- Active Adapter is set to Auto. From the control panel, navigate to:
Settings > Network/Ports > Network Overview > Active Adapter

For non-touch-screen printer models, press **OK** to navigate through the settings.

Using the Push Button method

1. From the control panel, navigate to:
Settings > Network/Ports > Wireless > Wi-Fi Protected Setup > Start Push Button Method

For non-touch-screen printer models, press **OK** to navigate through the settings.

2. Follow the instructions on the display.

Using the personal identification number (PIN) method

1. From the control panel, navigate to:
Settings > Network/Ports > Wireless > Wi-Fi Protected Setup > Start PIN Method

For non-touch-screen printer models, press **OK** to navigate through the settings.

2. Copy the eight-digit WPS PIN.
3. Open a web browser, and then type the IP address of your access point in the address field.
 - To know the IP address, see the documentation that came with your access point.
 - If you are using a proxy server, then temporarily disable it to load the web page correctly.
4. Access the WPS settings. For more information, see the documentation that came with your access point.
5. Enter the eight-digit PIN, and then save the changes.

Configuring Wi-Fi Direct

Wi-Fi Direct is a Wi-Fi-based peer-to-peer technology that allows wireless devices to connect directly to a Wi-Fi Direct-enabled printer without using an access point (wireless router).

1. From the control panel, navigate to:

Settings > Network/Ports > Wi-Fi Direct

For non-touch-screen printer models, press **OK** to navigate through the settings.

2. Configure the settings.
 - **Enable Wi-Fi Direct**—Enables the printer to broadcast its own Wi-Fi Direct network.
 - **Wi-Fi Direct Name**—Assigns a name for the Wi-Fi Direct network.
 - **Wi-Fi Direct Password**—Assigns the password for negotiating the wireless security when using the peer-to-peer connection.
 - **Show Password on Setup Page**—Shows the password on the Network Setup Page.

- **Auto-Accept Push Button Requests**—Lets the printer accept connection requests automatically.

 **Note:** Accepting push-button requests automatically is not secured.

- By default, the Wi-Fi Direct network password is not visible on the printer display. To show the password, enable the password peek icon. From the control panel, navigate to **Settings > Security > Miscellaneous > Enable Password/PIN Reveal**.
- To know the password of the Wi-Fi Direct network without showing it on the printer display, from the control panel navigate to **Settings > Reports > Network > Network Setup Page**.

Connecting a Mobile Device to the Printer

Before connecting your mobile device, make sure that Wi-Fi Direct has been configured. For more information, see [Configuring Wi-Fi Direct](#).

Connecting Using Wi-Fi Direct

 **Note:** These instructions apply only to Android mobile devices.

1. From the mobile device, go to the settings menu.
2. Enable **Wi-Fi**, and then tap **Wi-Fi Direct**.
3. Select the printer Wi-Fi Direct name.
4. Confirm the connection on the printer control panel.

Connecting Using Wi-Fi

1. From the mobile device, go to the settings menu.
2. Tap **Wi-Fi**, and then select the printer Wi-Fi Direct name.

 **Note:** The string DIRECT-xy (where x and y are two random characters) is added before the Wi-Fi Direct name.

3. Enter the Wi-Fi Direct password.

Connecting a Computer to the Printer

Before connecting your computer, make sure to do the following:

- Enable Wi-Fi Direct in the printer. From the control panel, navigate to:
Settings > Network/Ports > Wi-Fi Direct > Enable Wi-Fi Direct > On
- Take note of the Wi-Fi Direct name. From the control panel, navigate to:
Settings > Network/Ports > Wi-Fi Direct > Wi-Fi Direct Name
- Take note of the Wi-Fi Direct password. From the control panel, navigate to:
Settings > Network/Ports > Wi-Fi Direct > Wi-Fi Direct Password
-

 **Note:** You can also configure the Wi-Fi Direct name and password.

For non-touch-screen printer models, press **OK** to navigate through the settings.

For Windows Users

1. Open **Printers & scanners**, and then click **Add a printer or scanner**.
2. Click **Show Wi-Fi Direct printers**, and then select the printer Wi-Fi Direct name.
3. From the printer display, take note of the eight-digit PIN of the printer.
4. Enter the PIN on the computer.

 **Note:** If the print driver is not already installed, then Windows downloads the appropriate driver.

For Macintosh Users

1. Click the wireless icon, and then select the printer Wi-Fi Direct name.

 **Note:** The string DIRECT-xy (where x and y are two random characters) is added before the Wi-Fi Direct name.

2. Type the Wi-Fi Direct password.

 **Note:** Switch your computer back to its previous network after disconnecting from the Wi-Fi Direct connection.

Deactivating the Wi-Fi network

1. From the printer control panel, navigate to:

Settings > Network/Ports > Network Overview > Active Adapter > Standard Network

For non-touch-screen printer models, press **OK** to navigate through the settings.

2. Follow the instructions on the display.

Checking the printer connectivity

1. Print the Network Setup Page.

From the control panel, navigate to:

Settings > Reports > Network > Network Setup Page

For non-touch-screen printer models, press **OK** to navigate through the settings.

2. Check the first section of the page and confirm that the status is connected.

If the status is not connected, then the LAN drop may be inactive or the network cable may be unplugged or malfunctioning. Contact your administrator for assistance.

Set up, install, and configure

Printing the Menu Settings Page

From the control panel, navigate to:

Settings > Reports > Menu Settings Page

For non-touch-screen printer models, press  to navigate through the settings.

Secure the printer

This chapter contains:

- Erasing printer memory..... 68
- Restoring factory default settings..... 69
- Statement of Volatility..... 70

Erasing printer memory

To erase volatile memory or buffered data, turn off the printer.

To erase non-volatile memory or individual settings, device and network settings, security settings, and embedded solutions, do the following:

1. From the control panel, navigate to:

Settings > Device > Maintenance > Out of Service Erase > Sanitize all information on nonvolatile memory

For non-touch-screen printer models, press **OK** to navigate through the settings.

2. Select either **Start initial setup** or **Leave printer offline**.

Restoring factory default settings

1. From the control panel, navigate to:

Settings > Device > Restore Factory Defaults

For non-touch-screen printer models, press **OK** to navigate through the settings.

2. Select **Restore all settings**.

Statement of Volatility

Your printer contains various types of memory that can store device and network settings, and user data.

Type of memory	Description
Volatile memory	Your printer uses standard <i>random access memory</i> (RAM) to temporarily buffer user data during simple print jobs.
Non-volatile memory	Your printer may use two forms of non-volatile memory: EEPROM and NAND (flash memory). Both types are used to store operating system, device settings, and network information.

Erase the content of any installed printer memory in the following circumstances:

- The printer is being decommissioned.
- The printer is being moved to a different department or location.
- The printer is being serviced by someone from outside your organization.
- The printer is being removed from your premises for service.
- The printer is being sold to another organization.

Print

This chapter contains:

- Printing from a Computer..... 72
- Printing from a Mobile Device 73
- Printing from a flash drive 75
- Supported flash drives and file types 76
- Configuring confidential jobs 77
- Printing confidential and other held jobs..... 78
- Printing a font sample list 80
- Placing separator sheets between copies..... 81
- Canceling a print job..... 82
- Adjusting toner darkness..... 83

Printing from a Computer



Note: For labels, card stock, and envelopes, set the paper size and type in the printer before printing the document.

1. From the document that you are trying to print, open the Print dialog.
2. If necessary, adjust the settings.
3. Print the document.

Printing from a Mobile Device

Printing from a Mobile Device Using Mopria™ Print Service

Mopria Print Service is a mobile printing solution for mobile devices running on Android™ version 5.0 or later. It allows you to print directly to any Mopria-certified printer.



Note: Make sure that you download the Mopria Print Service application from the Google Play™ store and enable it in the mobile device.

1. From your Android mobile device, launch a compatible application or select a document from your file manager.
2. Tap **More Options > Print**.
3. Select a printer, and then adjust the settings, if necessary.
4. Tap **Print**.

Printing from a Mobile Device Using AirPrint®

The AirPrint software feature is a mobile printing solution that allows you to print directly from Apple devices to an AirPrint-certified printer.



- Make sure that the Apple device and the printer are connected to the same network. If the network has multiple wireless hubs, then make sure that both devices are connected to the same subnet.
 - This application is supported only in some Apple devices.
1. From your mobile device, select a document from your file manager or launch a compatible application.
 2. Tap **Share/Upload > Print**.
 3. Select a printer, and then adjust the settings, if necessary.
 4. Print the document.

Printing from a Mobile Device Using Wi-Fi Direct®

Wi-Fi Direct is a printing service that lets you print to any Wi-Fi Direct-ready printer.



Note: Make sure that the mobile device is connected to the printer wireless network. For more information, see [Connecting a Mobile Device to the Printer](#).

1. From your mobile device, launch a compatible application or select a document from your file manager.
2. Depending on your mobile device, do one of the following:
 - Tap  > **Print**.
 - Tap  > **Print**.

Print

- Tap **☰** > **Print**.
3. Select a printer, and then adjust the settings, if necessary.
 4. Print the document.

Printing from a flash drive

This feature is available only in some printer models.

1. Insert the flash drive.

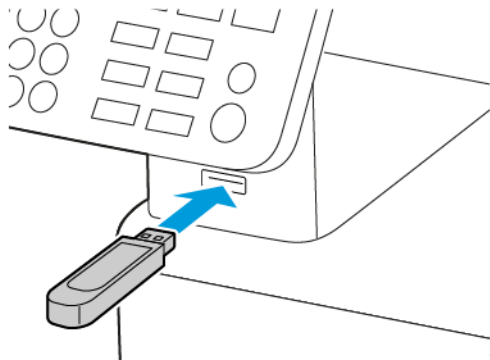

- If you insert the flash drive when an error message appears, then the printer ignores the flash drive.
 - If you insert the flash drive while the printer is processing other print jobs, then Busy appears on the display.
2. Select the document that you want to print.
If necessary, configure other print settings.
 3. Print the document.
To print another document, select **USB Drive**.

Warning: To avoid loss of data or printer malfunction, do not touch the flash drive or the printer in the area shown while actively printing, reading, or writing from the memory device.



Supported flash drives and file types

Flash drives

- Lexar JumpDrive S70 (16GB and 32GB)
- SanDisk Cruzer (16GB and 32GB)
- PNY Attache (16GB and 32GB)
 - The printer supports high-speed flash drives with full-speed standard.
 - Flash drives must support the File Allocation Table (FAT) system.

File types

Documents

PDF (version 1.7 or earlier)

Images

- .dcx
- .gif
- .JPEG or .jpg
- .bmp
- .pcx
- .TIFF or .tif
- .png

Configuring confidential jobs

Using the Control Panel

1. From the home screen, touch **Settings > Security > Confidential Print Setup**
2. Configure the settings.

Using the Embedded Web Server

1. Open a web browser, and then type the printer IP address in the address field.
 - View the printer IP address on the home screen. The IP address appears as four sets of numbers separated by periods, such as 123.123.123.123
 - If you are using a proxy server, then temporarily disable it to load the web page correctly.
2. Click **Settings > Security > Confidential Print Setup**.
3. Configure the settings.

Printing confidential and other held jobs

For Windows users

1. With a document open, click **File > Print**.
2. Select a printer, and then click **Properties, Preferences, Options, or Setup**.
3. Click **Print and Hold**.
4. Select **Use Print and Hold**, and then assign a user name.
5. Select the print job type (Confidential, Repeat, Reserve, or Verify).

If you select **Confidential**, then secure the print job with a personal identification number (PIN).

6. Click **OK** or **Print**.
7. From the printer control panel, release the print job.
 - For confidential print jobs, navigate to:
Held jobs > select your user name > Confidential > enter the PIN > select the print job > configure the settings > Print
 - For other print jobs, navigate to:
Held jobs > select your user name > select the print job > configure the settings > Print



Note: For non-touch-screen printer models, press **OK** to navigate through the settings.

For Macintosh users

Using AirPrint

1. With a document open, choose **File > Print**.
2. Select a printer, and then from the drop-down menu following the Orientation menu, choose **PIN Printing**.
3. Enable **Print with PIN**, and then enter a four-digit PIN.
4. Click **Print**.
5. From the printer control panel, release the print job. Navigate to:
Held jobs > select your computer name > Confidential > enter the PIN > select the print job > Print

For non-touch-screen printer models, press **OK** to navigate through the settings.

Using the print driver

1. With a document open, choose **File > Print**.
2. Select a printer, and then from the drop-down menu following the Orientation menu, choose **Print and Hold**.
3. Choose **Confidential Print**, and then enter a four-digit PIN.

4. Click **Print**.
5. From the printer control panel, release the print job. Navigate to:
Held jobs > select your computer name > **Confidential** > select the print job > enter the PIN > **Print**

For non-touch-screen printer models, press **OK** to navigate through the settings.

Printing a font sample list

1. From the control panel, navigate to:

Settings > Reports > Print > Print Fonts

For non-touch-screen printer models, press **OK** to navigate through the settings.

2. Select **PCL Fonts**.

Placing separator sheets between copies

1. From the home screen, navigate to:



Settings > Print > Layout > Separator Sheets > Between Copies

For non-touch-screen printer models, press **OK** to navigate through the settings.

2. Print the document.

Canceling a print job

From the printer control panel

1. Depending on your printer model, do either of the following:
 - Press  twice, and then press .
 - Touch **Cancel Job**.
2. Select a print job to cancel.

From the computer

1. Depending on the operating system, do either of the following:
 - Open the printers folder, and then select your printer.
 - From the System Preferences in the Apple menu, navigate to your printer.
2. Select the job to cancel.

Adjusting toner darkness

1. From the control panel, navigate to:

Settings > Print > Quality > Toner Darkness

For non-touch-screen printer models, press **OK** to navigate through the settings.

2. Adjust the setting.
3. Apply the changes.

Print

Copy

This chapter contains:

- Using the automatic document feeder and scanner glass..... 86
- Making Copies 87
- Copying photos..... 88
- Copying on letterhead 89
- Copying on Both Sides of the Paper 90
- Reducing or enlarging copies..... 91
- Copying multiple pages onto a single sheet..... 92
- Collating copies..... 93
- Copying cards 94
- Creating a copy shortcut 95

Using the automatic document feeder and scanner glass

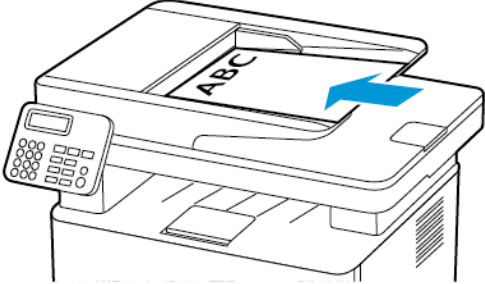
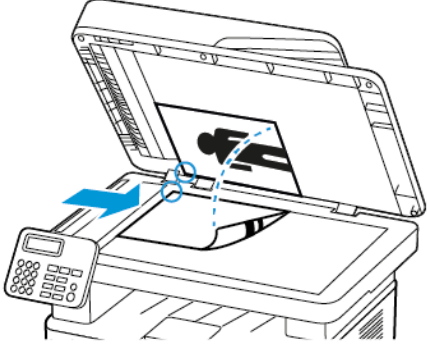
Automatic document feeder (ADF)	Scanner glass
 <ul style="list-style-type: none">• Use the ADF for multiple-page or two-sided documents.• Load an original document faceup. For multiple-page documents, make sure to align the leading edge before loading.• Make sure to adjust the ADF guides to match the width of the paper that you are loading.	 <ul style="list-style-type: none">• Use the scanner glass for single-page documents, book pages, small items (such as postcards or photos), transparencies, photo paper, or thin media (such as magazine clippings).• Place the document facedown in the corner with the arrow.

Making Copies

1. Load an original document into the ADF tray or on the scanner glass.



Note: To avoid a cropped image, make sure that the original document and the output have the same paper size.

2. From the control panel, navigate to:



> **Copy** > specify the number of copies

For non-touch-screen printer models, press **OK** to navigate through the settings.

If necessary, adjust the settings.

3. Copy the document.



Note: To make a quick copy, from the control panel, press **OK**.

Copying photos

1. Place a photo on the scanner glass.
2. From the control panel, navigate to:

 > **Copy** > **Content Type** > **Photo**

For non-touch-screen printer models, press  to navigate through the settings.

3. Copy the document.

Copying on letterhead

1. Load an original document into the ADF tray or on the scanner glass.
2. From the control panel, navigate to:

 > **Copy** > **Copy from** > select the size of the original document

For non-touch-screen printer models, press  to navigate through the settings.

3. Select **Copy To**, and then select the paper source that contains the letterhead.

If you loaded the letterhead into the manual feeder, then navigate to:

Copy To > **Manual Feeder** > select a paper size > **Letterhead**

4. Copy the document.

Copying on Both Sides of the Paper

1. Load an original document into the ADF tray or on the scanner glass.
2. From the control panel, navigate to:

 > **Copy** > **Sides**

For non-touch-screen printer models, press  to navigate through the settings.

3. Adjust the setting.
4. Copy the document.

Reducing or enlarging copies

1. Load an original document into the ADF tray or on the scanner glass.
2. From the control panel, navigate to:

 > **Copy** > **Scale** > specify a scale value

For non-touch-screen printer models, press  to navigate through the settings.

 **Note:** Changing the size of the original document or output after setting Scale restores the scale value to Auto.

3. Copy the document.

Copying multiple pages onto a single sheet

1. Load an original document into the ADF tray or on the scanner glass.
2. From the control panel, navigate to:

 > **Copy** > **Pages per Side**

For non-touch-screen printer models, press  to navigate through the settings.

3. Adjust the settings.
4. Copy the document.

Collating copies

1. Load an original document into the ADF tray or on the scanner glass.
2. From the control panel, navigate to:

 > **Copy** > **Collate** > **On [1,2,1,2,1,2]**

For non-touch-screen printer models, press  to navigate through the settings.

3. Copy the document.

Copying cards

1. Load a card on the scanner glass.
2. Depending on your printer model, do either of the following:
 - From the home screen, touch **Copy > ID Copy**.
 - From the control panel, navigate to:
ID Card Copy > OK
3. If necessary, adjust the settings.
4. Copy the document.

Creating a copy shortcut



Note: You may need administrative rights to create a shortcut.

1. Open a web browser, and then type the printer IP address in the address field.
 - View the printer IP address on the home screen. The IP address appears as four sets of numbers separated by periods, such as 123.123.123.123.
 - If you are using a proxy server, then temporarily disable it to load the web page correctly.
2. Click **Shortcuts > Add Shortcut**.
3. From the Shortcut Type menu, select **Copy**, and then configure the settings.
4. Apply the changes.

Copy

Email

This chapter contains:

- Using the automatic document feeder and scanner glass..... 98
- Sending an Email..... 99

Using the automatic document feeder and scanner glass

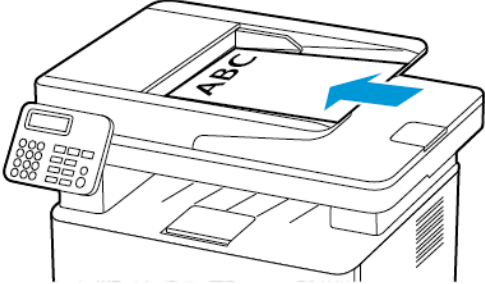
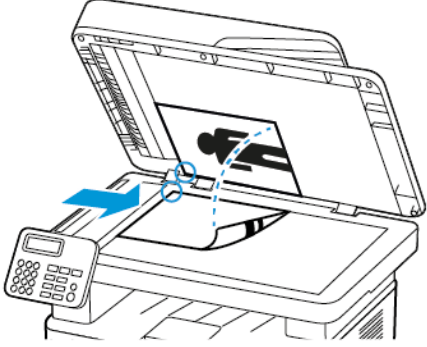
Automatic document feeder (ADF)	Scanner glass
 <ul style="list-style-type: none">• Use the ADF for multiple-page or two-sided documents.• Load an original document faceup. For multiple-page documents, make sure to align the leading edge before loading.• Make sure to adjust the ADF guides to match the width of the paper that you are loading.	 <ul style="list-style-type: none">• Use the scanner glass for single-page documents, book pages, small items (such as postcards or photos), transparencies, photo paper, or thin media (such as magazine clippings).• Place the document facedown in the corner with the arrow.

Sending an Email

Before you begin, make sure that the SMTP settings are configured. For more information, see [Configuring the Email SMTP Settings](#).

Using the Control Panel

1. Load an original document into the ADF tray or on the scanner glass.
2. From the home screen, touch **Email**, and then enter the needed information.
If necessary, configure the output file type settings.
3. Send the email.

Using a Shortcut Number

1. Create an email shortcut.
 - a. Open a web browser, and then type the printer IP address in the address field.
 - View the printer IP address on the home screen. The IP address appears as four sets of numbers separated by periods, such as 123.123.123.123.
 - If you are using a proxy server, then temporarily disable it to load the web page correctly.
 - b. Click **Shortcuts > Add Shortcut**.
 - c. From the Shortcut Type menu, select **Email**, and then configure the settings.
 - d. Apply the changes.
2. Load an original document into the ADF tray or on the scanner glass.
3. From the control panel, navigate to:
Shortcuts > Email
For non-touch-screen printer models, press **OK** to navigate through the settings.
4. Select the shortcut.
5. Send the email.

Email

Fax

This chapter contains:

- Using the automatic document feeder and scanner glass..... 102
- Sending a Fax 103
- Scheduling a fax 104
- Creating a fax destination shortcut 105
- Changing the fax resolution 106
- Adjusting the fax darkness 107
- Printing a fax log..... 108
- Blocking junk faxes 109
- Holding a fax 110
- Forwarding a fax 111

Using the automatic document feeder and scanner glass

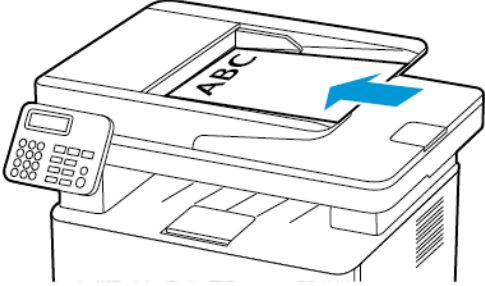
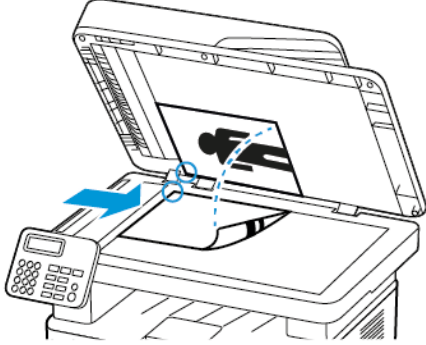
Automatic document feeder (ADF)	Scanner glass
 <ul style="list-style-type: none">• Use the ADF for multiple-page or two-sided documents.• Load an original document faceup. For multiple-page documents, make sure to align the leading edge before loading.• Make sure to adjust the ADF guides to match the width of the paper that you are loading.	 <ul style="list-style-type: none">• Use the scanner glass for single-page documents, book pages, small items (such as postcards or photos), transparencies, photo paper, or thin media (such as magazine clippings).• Place the document facedown in the corner with the arrow.

Sending a Fax

Using the Control Panel

1. Load an original document into the automatic document feeder input tray or on the scanner glass.
2. From the home screen, touch **Fax**, then enter the required information. Adjust the settings, as needed.
3. Fax the document.

Scheduling a fax

This feature is available only in some printer models.

1. Load an original document into the ADF tray or on the scanner glass.
2. From the home screen, touch **Fax** > **To** > enter the fax number > **Done**.
3. Touch **Send Time**, configure the date and time, and then touch **OK**.
4. Send the fax.

Creating a fax destination shortcut

 **Note:** You may need administrative rights to create a shortcut.

1. Open a web browser, and then type the printer IP address in the address field.
 - View the printer IP address on the home screen. The IP address appears as four sets of numbers separated by periods, such as 123.123.123.123.
 - If you are using a proxy server, then temporarily disable it to load the web page correctly.
2. Click **Shortcuts > Add Shortcut**.
3. From the Shortcut Type menu, select **Fax**, and then configure the settings.
4. Apply the changes.

Changing the fax resolution

1. Load an original document into the ADF tray or on the scanner glass.
2. From the control panel, touch **Fax > Resolution**.
3. Select a setting.
4. Fax the document.

Adjusting the fax darkness

1. Load an original document into the Automatic Document Feeder input tray or on the scanner glass.
2. From the control panel, touch **Fax > Darkness**.
3. Select a setting.
4. Fax the document.

Printing a fax log

1. From the control panel, touch **Settings > Reports > Fax**.
2. Select **Fax Job Log** or **Fax Call Log**.

Blocking junk faxes

1. From the home screen, navigate to **Settings > Fax > Fax Setup > Fax Receive Settings > Admin Controls**.
2. Set Block No Name Fax to **On**.

Holding a fax

1. Open a web browser, and then type the printer IP address in the address field.
 - View the printer IP address on the printer home screen. The IP address appears as four sets of numbers separated by periods, such as 123.123.123.123.
 - If you are using a proxy server, then temporarily disable it to load the web page correctly.
2. Click **Settings > Fax > Fax Setup > Fax Receive Settings > Holding Faxes**.
3. Select a mode.
4. Apply the changes.

Forwarding a fax

Using the control panel

1. Create a fax destination shortcut.
 - a. From the home screen, touch **Fax** > **To**.
 - b. Enter the recipient number, and then touch **Done**.
 - c. Touch .
 - d. Create a shortcut.
2. From the home screen, touch **Settings** > **Fax** > **Fax Setup** > **Fax Receive Settings** > **Admin Controls**.
3. In the Fax Forwarding menu, touch **Forward**.
4. In the Forward to menu, configure the destination.

Using the Embedded Web Server

1. Create a fax destination shortcut.
 - a. Open a web browser, and then type the printer IP address in the address field.
 - View the printer IP address on the home screen. The IP address appears as four sets of numbers separated by periods, such as 123.123.123.123.
 - If you are using a proxy server, then temporarily disable it to load the web page correctly.
 - b. Click **Shortcuts** > **Add Shortcut**.
 - c. From the Shortcut Type menu, select **Fax**, and then configure the settings.
 - d. Apply the changes.
2. Click **Settings** > **Fax** > **Fax Setup** > **Fax Receive Settings** > **Admin Controls**.
3. In the Fax Forwarding menu, select **Forward**.
4. In the Forward to menu, configure the destination.

Fax

Scan

This chapter contains:

- Using the automatic document feeder and scanner glass..... 114
- Scanning to a Computer 115
- Scanning to a flash drive..... 116
- Scanning to an FTP server 117
- Scanning to a network folder..... 118

Using the automatic document feeder and scanner glass

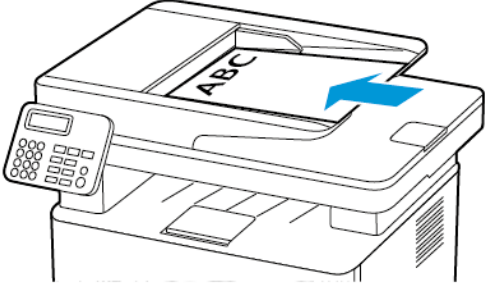
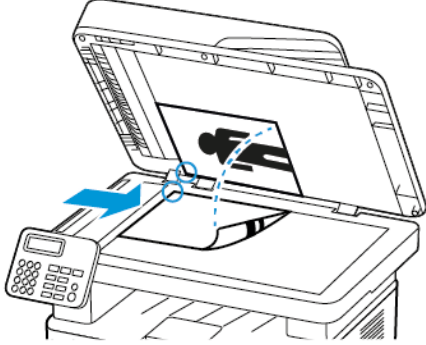
Automatic document feeder (ADF)	Scanner glass
 <ul style="list-style-type: none">• Use the ADF for multiple-page or two-sided documents.• Load an original document faceup. For multiple-page documents, make sure to align the leading edge before loading.• Make sure to adjust the ADF guides to match the width of the paper that you are loading.	 <ul style="list-style-type: none">• Use the scanner glass for single-page documents, book pages, small items (such as postcards or photos), transparencies, photo paper, or thin media (such as magazine clippings).• Place the document facedown in the corner with the arrow.

Scanning to a Computer

Before you begin, make sure that:

- The printer firmware is updated. For more information, see [Updating Firmware](#).
- The computer and the printer are connected to the same network.

For Windows users



Note: Make sure that the printer is added to the computer. For more information, refer to [Installing the Software](#).

1. Load an original document into the automatic document feeder or on the scanner glass.
2. From the computer, open **Windows Fax and Scan**.
3. From the Source menu, select a scanner source.
4. If necessary, change the scan settings.
5. Scan the document.

For Macintosh users



Note: Make sure that the printer is added to the computer. For more information, refer to [Installing the Software](#).

1. Load an original document into the automatic document feeder or on the scanner glass.
2. From the computer, do either of the following:
 - Open **Image Capture**.
 - Open **Printers & Scanners**, and then select a printer. Click **Scan > Open Scanner**.
3. From the Scanner window, do one or more of the following:
 - Select where you want to save the scanned document.
 - Select the size of the original document.
 - To scan from the ADF, select **Document Feeder** from the Scan Menu or enable **Use Document Feeder**.
 - If necessary, configure the scan settings.
4. Click **Scan**.

Scanning to a flash drive

This feature is available only in some printer models.

1. Load an original document into the ADF tray or on the scanner glass.
2. Insert the flash drive.

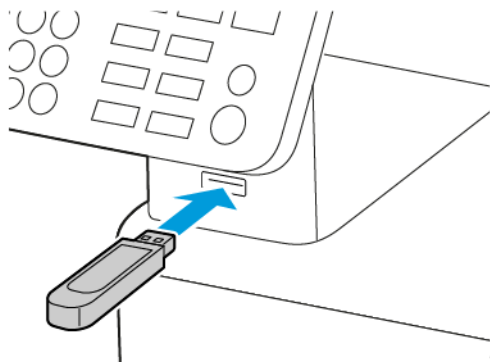

3. Touch **Scan to USB** and adjust the settings if necessary.
 - To save the scanned document to a folder, touch **Scan to**, select a folder, and then touch **Scan Here**.
 - If the USB Drive screen does not appear, then touch **USB Drive** on the control panel.
4. Scan the document.

 **Warning:** To avoid loss of data or printer malfunction, do not touch the flash drive or the printer in the area shown while actively printing, reading, or writing from the memory device.



Scanning to an FTP server

1. Create an FTP shortcut.
 - a. Open a web browser, and then type the printer IP address in the address field.
 - View the printer IP address on the printer home screen. The IP address appears as four sets of numbers separated by periods, such as 123.123.123.123.
 - If you are using a proxy server, then temporarily disable it to load the web page correctly.
 - b. Click **Shortcuts > Add Shortcut**.
 - c. From the Shortcut Type menu, select **FTP**, and then configure the settings.
 - d. Apply the changes.
2. Load an original document into the ADF tray or on the scanner glass.
3. From the control panel, navigate to:
Shortcuts > FTP
For non-touch-screen printer models, press **OK** to navigate through the settings.
4. Select the shortcut.
5. Scan the document.

Scanning to a network folder

1. Create a network folder shortcut.
 - a. Open a web browser, and then type the printer IP address in the address field.
 - View the printer IP address on the printer home screen. The IP address appears as four sets of numbers separated by periods, such as 123.123.123.123.
 - If you are using a proxy server, then temporarily disable it to load the web page correctly.
 - b. Click **Shortcuts > Add Shortcut**.
 - c. From the Shortcut Type menu, select **Network Folder**, and then configure the settings.
 - d. Apply the changes.
2. Load an original document into the ADF tray or on the scanner glass.
3. From the home screen, navigate to:
Shortcuts > Network Folder
For non-touch-screen printer models, press **OK** to navigate through the settings.
4. Select the shortcut.

Use printer menus

This chapter contains:



- Menu Map 120
- Device..... 121
- Print..... 131
- Paper 137
- Copy 140
- Fax..... 142
- E-mail 149
- FTP 154
- USB Drive 157
- Network/Ports 161
- Security 176
- Reports 181
- Troubleshooting..... 183

Menu Map



Device	<ul style="list-style-type: none"> • Preferences • Eco-Mode • Remote Operator Panel¹ • Notifications • Power Management 	<ul style="list-style-type: none"> • Restore Factory Defaults • Maintenance • Visible Home Screen Icons² • About This Printer
Print	<ul style="list-style-type: none"> • Layout • Setup • Quality • PDF² 	<ul style="list-style-type: none"> • PostScript² • PCL • Image
Paper	<ul style="list-style-type: none"> • Tray Configuration 	<ul style="list-style-type: none"> • Media Configuration
Copy	Copy Defaults	
Fax	Fax Defaults	
E-mail¹	<ul style="list-style-type: none"> • E-mail Setup 	<ul style="list-style-type: none"> • E-mail Defaults
FTP¹	FTP Defaults	
USB Drive²	<ul style="list-style-type: none"> • Flash Drive Scan 	<ul style="list-style-type: none"> • Flash Drive Print
Network/Ports	<ul style="list-style-type: none"> • Network Overview • Wireless • Wi-Fi Direct • Ethernet • TCP/IP • SNMP 	<ul style="list-style-type: none"> • IPSec • 802.1x • LPD Configuration • HTTP/FTP Settings • USB • Restrict external network access
Security¹	<ul style="list-style-type: none"> • Login Methods • Certificate Management • Schedule USB Devices² • Login Restrictions 	<ul style="list-style-type: none"> • Erase Temporary Data Files • Miscellaneous
Reports	<ul style="list-style-type: none"> • Menu Settings Page • Device • Print 	<ul style="list-style-type: none"> • Shortcuts • Fax • Network
Troubleshooting	<ul style="list-style-type: none"> • Print Quality Test Pages 	<ul style="list-style-type: none"> • Cleaning the Scanner
<p>¹ In some printer models, this menu can be configured from the Embedded Web Server only.</p> <p>² Available only in some printer models.</p>		

Device

Preferences

Menu item	Description
Display Language [List of languages]	Set the language of the text that appears on the display.
Country/Region [List of countries or regions]	Identify the country or region where the printer is configured to operate.
Run initial setup <ul style="list-style-type: none"> No* Yes 	Run the setup wizard.
Keyboard Keyboard Type [List of languages]	Select a language as a keyboard type.  Note: All the Keyboard Type values may not appear or may require special hardware to appear.
Displayed information <ul style="list-style-type: none"> Display Text 1 (IP Address*) Display Text 2 Custom Text 1 Custom Text 2 	Specify the information to appear on the home screen.
Date and Time <ul style="list-style-type: none"> Configure <ul style="list-style-type: none"> Current Date and Time Manually Set Date and Time Date Format [MM-DD-YYYY*] Time Format [12 hour A.M./P.M.*] Time Zone 	Configure the printer date and time.
Date and Time <ul style="list-style-type: none"> Network Time Protocol <ul style="list-style-type: none"> Enable NTP (On*) NTP Server Enable Authentication (None*) 	Configure the settings for Network Time Protocol (NTP).  Note: When Enable Authentication is set to MD5 key, Key ID and Password appear.
Paper Sizes <ul style="list-style-type: none"> U.S.* Metric 	Specify the unit of measurement for paper sizes.  Note: The country or region selected in the initial setup wizard determines the initial paper size setting.

Use printer menus



Menu item	Description
Screen Brightness 20–100 % (100*)	Adjust the brightness of the display.  Note: This feature is available only in some printer models.
Flash Drive Access <ul style="list-style-type: none"> • Disabled • Enabled* 	Enable access to the flash drive.
One Page Flatbed Scanning <ul style="list-style-type: none"> • On • Off* 	Set copies from the scanner glass to only one page at a time.
Screen Timeout 5–300 (60*)	Set the idle time in seconds before the display shows the home screen, or before the printer logs out a user account automatically.
 Note: An asterisk (*) next to a value indicates the factory default setting.	

Eco-Mode

Menu item	Description
Print: Sides <ul style="list-style-type: none"> • 1-Sided* • 2-Sided 	Specify whether to print on one side or two sides of the paper.
Print : Pages per Side <ul style="list-style-type: none"> • Off* • 2 pages per side • 3 pages per side • 4 pages per side • 6 pages per side • 9 pages per side • 12 pages per side • 16 pages per side 	Print multiple page images on one side of a sheet of paper.
Print : Toner Darkness <ul style="list-style-type: none"> • Light • Normal* • Dark 	Determine the lightness or darkness of text or images.
Copy :Sides <ul style="list-style-type: none"> • 1 sided to 1 sided* • 1 sided to 2 sided 	Specify whether to print on one side or both sides of the paper.
Copy :Pages per Side <ul style="list-style-type: none"> • Off* 	Specify the number of page images to print on one side of a sheet of paper.

Menu item	Description
<ul style="list-style-type: none"> • 2 Portrait pages • 4 Portrait pages • 2 Landscape pages • 4 Landscape pages 	
Copy <ul style="list-style-type: none"> • Darkness • 1-9 (5*) 	Adjust the darkness of the scanned image.
 Note: An asterisk (*) next to a value indicates the factory default setting.	

Remote Operator Panel



Menu item	Description
External VNC Connection <ul style="list-style-type: none"> • Don't Allow* • Allow 	Connect an external Virtual Network Computing (VNC) client to the remote control panel.
Authentication Type <ul style="list-style-type: none"> • None* • Standard Authentication 	Set the authentication type when accessing the VNC client server.
VNC Password	Specify the password to connect to the VNC client server.  Note: This menu item appears only if Authentication Type is set to Standard Authentication.
 Note: An asterisk (*) next to a value indicates the factory default setting.	

Notifications

Menu item	Description
ADF Loaded Beep <ul style="list-style-type: none"> • Off • On* 	Enable a sound when loading paper into the ADF.
Alarm Control <ul style="list-style-type: none"> • Off • Single* • Continuous 	Set the number of times that the alarm sounds when the printer requires user intervention.

Use printer menus

Menu item	Description
Supplies : Show Supply Estimates <ul style="list-style-type: none"> • Show estimates* • Do not show estimates 	Show the estimated status of the supplies.
Supplies : Cartridge Alarm <ul style="list-style-type: none"> • Off* • Single • Continuous 	Set the number of times that the alarm sounds when the cartridge is low.
Supplies Custom Supply Notifications	Configure notification settings when the printer requires user intervention.  Note: This menu item appears only in the Embedded Web Server.
E-mail Alerts Setup : E-mail Setup <ul style="list-style-type: none"> • Primary SMTP Gateway • Primary SMTP Gateway Port (25*) • Secondary SMTP Gateway • Secondary SMTP Gateway Port (25*) • SMTP Timeout (30 seconds*) • Reply Address • Always use SMTP default Reply Address (Off*) • Use SSL/TLS (Disabled*) • Require Trusted Certificate (On*) • SMTP Server Authentication • (No authentication required*) • Device-Initiated E-mail (None*) • Device Userid • Device Password • NTLM Domain 	Configure the e-mail settings of the printer.
Error Prevention : Jam Assist <ul style="list-style-type: none"> • Off • On* 	Set the printer to check for jammed paper automatically.
Error Prevention : Auto Continue <ul style="list-style-type: none"> • Disabled • Enabled* (5 seconds) • Auto Continue Time 	Let the printer continue processing or printing a job automatically after clearing certain attendance conditions.
Error Prevention : Auto Reboot <ul style="list-style-type: none"> • Auto Reboot (Reboot always*) 	Set the printer to restart when an error occurs.
Error Prevention :Auto Reboot <ul style="list-style-type: none"> • Max Auto Reboots (2*) 	Set the number of automatic reboots that the printer can perform.
Error Prevention : Auto Reboot <ul style="list-style-type: none"> • Auto Reboot Window (720*) 	Set the number of seconds before the printer performs an automatic reboot.

Menu item	Description
Error Prevention: Auto Reboot <ul style="list-style-type: none"> Auto Reboot Counter 	Show a read-only information of the reboot counter.
Error Prevention: Display Short Paper Error <ul style="list-style-type: none"> Auto-clear* On 	Set the printer to show a message when a short paper error occurs.  Note: Short paper refers to the size of the paper loaded.
Error Prevention : Page Protect <ul style="list-style-type: none"> Off* On 	Set the printer to process the entire page into the memory before printing it.
Jam Content Recovery : Jam Recovery <ul style="list-style-type: none"> Auto* Off On 	Set the printer to reprint jammed pages.
Jam Content Recovery : Scanner Jam Recovery <ul style="list-style-type: none"> Job level Page level* 	Specify how to restart a scan job after resolving a paper jam.
 Note: An asterisk (*) next to a value indicates the factory default setting.	

Power Management

Menu item	Description
Sleep Mode Profile : Print from Sleep Mode <ul style="list-style-type: none"> Stay awake after printing Enter Sleep Mode after printing* 	Set the printer to stay in Ready mode or return to Sleep mode after printing.
Timeouts : Sleep Mode <ul style="list-style-type: none"> 1–120 minutes (15*) 	Set the idle time before the printer begins operating in Sleep mode.
Timeouts : Hibernate Timeout <ul style="list-style-type: none"> Disabled 1 hour 2 hours 3 hours 6 hours 1 day 2 days 3 days* 1 week 2 weeks 1 month 	Set the time before the printer turns off.

Use printer menus

Menu item	Description
Timeouts : Hibernate Timeout on Connection <ul style="list-style-type: none">• Hibernate• Do Not Hibernate*	Set Hibernate Timeout to turn off the printer while an active Ethernet connection exists.
 Note: An asterisk (*) next to a value indicates the factory default setting.	

Restore Factory Defaults

Menu item	Description
Restore Settings <ul style="list-style-type: none">• Restore all settings• Restore printer settings• Restore network settings• Restore fax settings	Restore the printer factory default settings.





Maintenance

Config Menu

Menu item	Description
USB Configuration : USB PnP <ul style="list-style-type: none">• 1*• 2	Change the USB driver mode of the printer to improve its compatibility with a personal computer.
USB Configuration : USB Scan to Local <ul style="list-style-type: none">• On*• Off	Set whether the USB device driver enumerates as a USB Simple device (single interface) or as a USB Composite device (multiple interfaces).
USB Configuration : USB Speed <ul style="list-style-type: none">• Full• Auto*	Set the USB port to run at full speed and disable its high-speed capabilities.
Tray Configuration : Show Tray Insert Message <ul style="list-style-type: none">• Off• Only for unknown sizes*• Always	Show message about the tray status.
Tray Configuration : A5 Loading <ul style="list-style-type: none">• Short Edge• Long Edge*	Specify the page orientation when loading A5 paper size.

Menu item	Description
Tray Configuration : Paper Prompts <ul style="list-style-type: none"> • Auto* • Manual Paper 	Set the paper source that the user fills when a prompt to load paper appears.
Tray Configuration : Envelope Prompts <ul style="list-style-type: none"> • Auto* • Manual Envelope 	Set the paper source that the user fills when a prompt to load envelope appears.
Tray Configuration : Action for Prompts <ul style="list-style-type: none"> • Prompt user* • Continue • Use current 	Set the printer to resolve paper- or envelope-related change prompts.
Reports : Menu Settings Page <ul style="list-style-type: none"> • Event Log • Event Log Summary 	Print reports about printer menu settings, status, and event logs.
Supply Usage And Counters Clear Supply Usage History	Reset the supply page counter or view the total printed pages.
Printer Emulations : PS Emulation <ul style="list-style-type: none"> • Off* • On 	Set the printer to recognize and use the PS data stream.  Note: This menu item appears only in some printer models.
Printer Emulations : Emulator Security <ul style="list-style-type: none"> • Page Timeout (60*) 	Set the page timeout during emulation.
Printer Emulations : Emulator Security <ul style="list-style-type: none"> • Reset Emulator After Job (Off*) 	Reset the emulator after a print job.
Printer Emulations : Emulator Security <ul style="list-style-type: none"> • Disable Printer Message Access (On*) 	Disable access to the printer message during emulation.
Fax Configuration : Fax Low Power Support <ul style="list-style-type: none"> • Disable Sleep • Permit Sleep • Auto* 	Specify the printer power setting when it is in fax mode.
Print Configuration : Font Sharpening <ul style="list-style-type: none"> • 0–150 (24*) 	Set a text point-size value below which the high-frequency screens are used when printing font data.
Print Configuration <ul style="list-style-type: none"> • Print Density <ul style="list-style-type: none"> – Disabled – 1–5 (3*) • Copy Density 	Adjust the toner density when printing or copying documents.

Use printer menus

Menu item	Description
<ul style="list-style-type: none"> – Copy Density – 1–5 (3*) 	
<p>Device Operations : Quiet Mode</p> <ul style="list-style-type: none"> • On • Off* 	<p>Set the printer to reduce the amount of noise that it makes when printing.</p> <p> Note: Enabling this setting slows down the printer performance.</p>
<p>Device Operations : Panel Menus</p> <ul style="list-style-type: none"> • Enable* • Disable 	<p>Set the printer to enable access to the control panel menus.</p> <p> Note: This menu item appears only in the Embedded Web Server.</p>
<p>Device Operations</p> <p>Clear Custom Status</p>	<p>Erase all custom messages.</p>
<p>Device Operations</p> <p>Clear all remotely-installed messages</p>	<p>Erase messages that were remotely installed.</p>
<p>Device Operations : Automatically Display Error Screens</p> <ul style="list-style-type: none"> • On* • Off 	<p>Show existing error messages on the display after the printer remains inactive on the home screen for a length of time equal to the Screen Timeout setting.</p> <p> Note: This menu item appears only in some printer models.</p>
<p>Scanner Configuration : Scanner Manual Registration</p> <ul style="list-style-type: none"> • Print Quick Test 	<p>Print a Quick Test target page.</p> <p> Note: Make sure that the margin spacing on the target page is uniform all the way around the target. If it is not, then the printer margins may need to be reset.</p>
<p>Scanner Configuration : Scanner Manual Registration</p> <ul style="list-style-type: none"> • Front ADF Registration • Flatbed Registration 	<p>Manually register the flatbed and ADF after replacing the ADF, scanner glass, or controller board.</p>
<p>Scanner Configuration : Edge Erase</p> <ul style="list-style-type: none"> • ADF Edge Erase <ul style="list-style-type: none"> – 0–6 (3*) • Flatbed Edge Erase <ul style="list-style-type: none"> – 0–6 (3*) 	<p>Set the size, in millimeters, of the no-print area around an ADF or flatbed scan job.</p>
<p>Scanner Configuration : Disable Scanner</p> <ul style="list-style-type: none"> • Enabled* • Disabled • ADF Disabled 	<p>Disable the scanner if it is not working properly.</p>

Menu item	Description
Scanner Configuration : Tiff Byte Order <ul style="list-style-type: none"> • CPU Endianness* • Little Endian • Big Endian 	Set the byte order of a TIFF-formatted scan output.
Scanner Configuration : Exact Tiff Rows Per Strip <ul style="list-style-type: none"> • On* • Off 	Set the RowsPerStrip tag value of a TIFF-formatted scan output.
 Note: An asterisk (*) next to a value indicates the factory default setting.	

Out of Service Erase

Menu item	Description
<ul style="list-style-type: none"> • Printer Memory Last Sanitized • Sanitize all information on nonvolatile memory • Erase all printer and network settings • Erase all shortcuts and shortcut settings 	Clear all settings and shortcuts that are stored in the printer.  Note: Erase all shortcuts and shortcut settings is available only in some printer models.

Visible Home Screen Icons

Menu	Description
<ul style="list-style-type: none"> • Copy • E-mail • Fax • Status/Supplies • Job Queue • Change Language • Held Jobs • USB • Scan to Computer 	Specify which icons to show on the home screen.

About This Printer



Menu item	Description
Xerox Asset Tag	The maximum length is 32 characters.
Customer Asset Tag	Describe the printer. The maximum length is 32 characters.

Use printer menus

Menu item	Description
Printer Location	Identify the printer location. The maximum length is 63 characters.
Contact	Personalize the printer name. The maximum length is 63 characters.
Export Configuration File to USB*	Export configuration files to a flash drive.
Export Compressed Logs to USB*	Export compressed log files to a flash drive.
* This menu item appears only in some printer models.	

Print



Layout

Menu item	Description
Sides <ul style="list-style-type: none"> • 1-sided* • 2-sided 	Specify whether to print on one side or two sides of the paper.
Flip Style <ul style="list-style-type: none"> • Long Edge* • Short Edge 	Determine which side of the paper (long edge or short edge) is bound when performing two-sided printing.  Note: Depending on the option selected, the printer automatically offsets each printed information of the page to bind the job correctly.
Blank Pages <ul style="list-style-type: none"> • Print • Do Not Print* 	Print blank pages that are included in a print job.
Collate <ul style="list-style-type: none"> • Off [1,1,1,2,2,2] • On [1,2,1,2,1,2]* 	Keep the pages of a print job stacked in sequence, particularly when printing multiple copies of the job.
Separator Sheets <ul style="list-style-type: none"> • None* • Between Copies • Between Jobs • Between Pages 	Insert blank separator sheets when printing.
Separator Sheet Source Tray [x] (1*)	Specify the paper source for the separator sheet.
Pages per Side <ul style="list-style-type: none"> • Off* • 2 pages per side • 3 pages per side • 4 pages per side • 6 pages per side • 9 pages per side • 12 pages per side • 16 pages per side 	Print multiple page images on one side of a sheet of paper.
Pages per Side Ordering <ul style="list-style-type: none"> • Horizontal* • Reverse Horizontal • Vertical • Reverse Vertical 	Specify the positioning of multiple page images when using Pages per Side.  Note: The positioning depends on the number of page images and their page orientation.



Use printer menus

Menu item	Description
Pages per Side Orientation <ul style="list-style-type: none"> • Auto* • Landscape • Portrait 	Specify the orientation of a multiple-page document when using Pages per Side.
Pages per Side Border <ul style="list-style-type: none"> • None* • Solid 	Print a border around each page image when using Pages per Side.
Copies 1–9999 (1*)	Specify the number of copies for each print job.
Print Area <ul style="list-style-type: none"> • Normal* • Whole Page 	Set the printable area on a sheet of paper.
 Note: An asterisk (*) next to a value indicates the factory default setting.	

Setup

Menu item	Description
Printer Language <ul style="list-style-type: none"> • PCL Emulation • PS Emulation 	Set the printer language.  Note: Setting a printer language default does not prevent a software program from sending print jobs that use another printer language.
Resource Save <ul style="list-style-type: none"> • On • Off* 	Determine what the printer does with downloaded resources, such as fonts and macros, when it receives a job that requires more than the available memory. <ul style="list-style-type: none"> • When set to Off, the printer retains downloaded resources only until memory is needed. Resources associated with the inactive printer language are deleted. • When set to On, the printer preserves all the permanent downloaded resources across all language switches. When necessary, the printer shows memory full messages instead of deleting permanent resources.
Print All Order <ul style="list-style-type: none"> • Alphabetical* • Newest First • Oldest First 	Specify the order you choose to print all held and confidential jobs.
 Note: An asterisk (*) next to a value indicates the factory default setting.	



Quality

Menu item	Description
Print Resolution <ul style="list-style-type: none"> • 300 dpi • 600 dpi* • 1200 Image Q • 2400 Image Q 	Set the resolution for the text and images on the printed output.  Note: Resolution is determined in dots per inch or image quality.
Toner Darkness <ul style="list-style-type: none"> • Light • Normal* • Dark 	Determine the lightness or darkness of text images.
Halftone <ul style="list-style-type: none"> • Normal* • Detail 	Enhance the printed output to have smoother lines with sharper edges.
 Note: An asterisk (*) next to a value indicates the factory default setting.	



PDF





Menu item	Description
Scale To Fit <ul style="list-style-type: none"> • Yes • No* 	Scale the page content to fit the selected paper size.
Annotations <ul style="list-style-type: none"> • Print • Do Not Print* 	Specify whether to print annotations in the PDF.
Print PDF Error <ul style="list-style-type: none"> • Off • On* 	Enable the printing of PDF error.
 Note: An asterisk (*) next to a value indicates the factory default setting.	

PostScript





Menu item	Description
Print PS Error <ul style="list-style-type: none"> • Off* • On 	Print a page that describes the PostScript® error.  Note: When an error occurs, processing of the job stops, the printer prints an error message, and the rest of the print job is flushed.
Minimum Line Width 1–30 (2*)	Set the minimum stroke width of any job printed in 1200 dpi.
Lock PS Startup Mode <ul style="list-style-type: none"> • Off • On* 	Disable the SysStart file.
Wait Timeout <ul style="list-style-type: none"> • Disabled • Enabled* 	Enable the printer to wait for more data before canceling a print job.
Wait Timeout Time 15–65535 (40*)	Set the time in seconds for the printer to wait for more data before canceling a print job.  Note: This menu item appears only when Wait Timeout is enabled.
 Note: An asterisk (*) next to a value indicates the factory default setting.	

PCL

Menu item	Description
Font Name [List of available fonts] (Courier*)	Select a font from the specified font source.
Symbol Set [List of available symbol set] (10U PC-8*)	Specify the symbol set for each font name.  Note: A symbol set is a set of alphabetic and numeric characters, punctuation, and special symbols. Symbol sets support the different languages or specific programs such as math symbols for scientific text.
Pitch 0.08–100 (10*)	Specify the pitch for fixed or monospaced fonts.  Note: Pitch refers to the number of fixed-space characters in a horizontal inch of type.

Menu item	Description
Orientation <ul style="list-style-type: none"> • Portrait* • Landscape • Reverse Portrait • Reverse Landscape 	Specify the orientation of text and graphics on the page.
Lines per Page 1–255	Specify the number of lines of text for each page printed through the PCL data stream. <ul style="list-style-type: none"> • This menu item activates vertical escapement that causes the selected number of requested lines to print between the default margins of the page. • 60 is the U.S. factory default setting. 64 is the international factory default setting.
PCL5 Minimum Line Width 1–30 (2*)	Set the initial minimum stroke width of any job printed in 1200 dpi.
PCLXL Minimum Line Width 1–30 (2*)	
A4 Width <ul style="list-style-type: none"> • 198mm* • 203mm 	Set the width of the logical page on A4-size paper.  Note: Logical page is the space on the physical page where data is printed.
Auto CR after LF <ul style="list-style-type: none"> • Off* • On 	Set the printer to perform a carriage return after a line feed control command.  Note: Carriage return is a mechanism that commands the printer to move the position of the cursor to the first position on the same line.
Auto LF after CR <ul style="list-style-type: none"> • Off* • On 	Set the printer to perform a line feed after a carriage return control command.
Print Timeout <ul style="list-style-type: none"> • Disabled • Enabled* 	Enable the printer to end a print job after it has been idle for the specified amount of time in seconds.
Print Timeout Time 1–255 (90*)	Set the time in seconds for the printer to end a print job after it has been idle.  Note: This menu item appears only when Print Timeout is enabled.
 Note: An asterisk (*) next to a value indicates the factory default setting.	

Image

Menu item	Description
<p>Auto Fit</p> <ul style="list-style-type: none"> • On • Off* 	<p>Select the best available paper size and orientation setting for an image.</p> <p> Note: When set to On, this menu item overrides the scaling and orientation settings for the image.</p>
<p>Invert</p> <ul style="list-style-type: none"> • Off* • On 	<p>Invert bitonal monochrome images.</p> <p> Note: This menu item does not apply to GIF or JPEG image formats.</p>
<p>Scaling</p> <ul style="list-style-type: none"> • Anchor Top Left • Best Fit* • Anchor Center • Fit Height/Width • Fit Height • Fit Width 	<p>Adjust the image to fit the printable area.</p> <p> Note: When Auto Fit is set to On, Scaling is automatically set to Best Fit.</p>
<p>Orientation</p> <ul style="list-style-type: none"> • Portrait* • Landscape • Reverse Portrait • Reverse Landscape 	<p>Specify the orientation of text and graphics on the page.</p>
<p> Note: An asterisk (*) next to a value indicates the factory default setting.</p>	

Paper

Tray Configuration



Menu item	Description
Default Source <ul style="list-style-type: none"> • Tray [x] (1*) • Manual Paper • Manual Envelope 	Set the paper source for all print jobs.
Paper Size/Type <ul style="list-style-type: none"> • Tray [x] (1*) • Manual Paper • Manual Envelope 	Specify the paper size or paper type loaded in each paper source.
Substitute Size <ul style="list-style-type: none"> • Off • Letter/A4 • All Listed* 	Set the printer to substitute a specified paper size if the requested size is not loaded in any paper source. <ul style="list-style-type: none"> • Off prompts the user to load the required paper size. • Letter/A4 prints an A4-size document on letter when loading letter, and letter-size jobs on A4 paper size when loading A4. • All Listed substitutes Letter/A4.
 Note: An asterisk (*) next to a value indicates the factory default setting.	

Media Configuration

Universal Setup

Menu item	Description
Units of Measure <ul style="list-style-type: none"> • Inches • Millimeters 	Specify the unit of measurement for the universal paper.  Note: Inches is the U.S. factory default setting. Millimeters is the international factory default setting.
Portrait Width <ul style="list-style-type: none"> • 3.00–14.17inches (8.50*) • 76–360mm (216*) 	Set the portrait width of the universal paper.
Portrait Height <ul style="list-style-type: none"> • 3.00–14.17inches (14*) 	Set the portrait height of the universal paper.

Use printer menus

Menu item	Description
<ul style="list-style-type: none">• 76–360mm (356*)	
Feed Direction <ul style="list-style-type: none">• Short Edge*• Long Edge	Set the printer to pick paper from the short edge or long edge direction.  Note: Long Edge appears only when the longest edge is shorter than the maximum width supported.
 Note: An asterisk (*) next to a value indicates the factory default setting.	

Custom Scan Sizes

Menu item	Description
Custom Scan Size [x] <ul style="list-style-type: none">• Scan Size Name• Width<ul style="list-style-type: none">– 1–8.50inches (8.50*)– 25–216mm (216*)• Height<ul style="list-style-type: none">– 1–14inches (11*)– 25–356mm (279*)• Orientation<ul style="list-style-type: none">– Portrait*– Landscape• 2 scans per side<ul style="list-style-type: none">– Off*– On	Assign a scan size name and configure the scan settings.
 Note: An asterisk (*) next to a value indicates the factory default setting.	

Media Types

Menu item	Description
<ul style="list-style-type: none">• Plain Paper• Card Stock• Recycled• Labels• Bond• Envelope• Letterhead• Preprinted• Colored Paper• Light• Heavy	Specify the texture, weight, and orientation of the paper loaded.

Copy

Copy Defaults

Menu item	Description
Content Type <ul style="list-style-type: none"> Text Text/Photo* Photo Graphics 	Improve the output result based on the content of the original document.
Sides <ul style="list-style-type: none"> 1 sided to 1 sided* 1 sided to 2 sided 	Specify the scanning behavior based on the original document.
Pages per Side <ul style="list-style-type: none"> Off* 2 Portrait pages 4 Portrait pages 2 Landscape pages 4 Landscape pages 	Specify the number of page images to print on one side of a sheet of paper.
Print Page Borders <ul style="list-style-type: none"> Off* On 	Place a border around each image when printing multiple pages on a single page.
Collate <ul style="list-style-type: none"> Off [1,1,1,2,2,2] On [1,2,1,2,1,2]* 	Print multiple copies in sequence.
“Copy from” Size [List of paper sizes]	Set the paper size of the original document.  Note: Letter is the U.S. factory default setting. A4 is the international factory default setting.
“Copy to” Source <ul style="list-style-type: none"> Tray [x] (1*) Manual Feeder Auto Size Match 	Specify the paper source for the copy job.
Darkness 1 to 9 (5*)	Adjust the darkness of the scanned image.
Number of Copies 1–9999 (1*)	Specify the number of copies.

Advanced Imaging

Menu item	Description
Contrast <ul style="list-style-type: none"> • Best for Content* • -0 • -1 • -2 • -3 • -4 • -5 	Specify the contrast of the output.
Background Removal <ul style="list-style-type: none"> • Level • -4 to 4 (0*) 	Adjust the amount of background visible on a scanned image.
Scan Edge to Edge <ul style="list-style-type: none"> • Off* • On 	Allow edge-to-edge scanning of the original document.
 Note: An asterisk (*) next to a value indicates the factory default setting.	

Fax

Fax Defaults



Fax Mode

Menu item	Description
Fax Mode <ul style="list-style-type: none"> Fax* Disabled 	Select a fax mode.
 Note: An asterisk (*) next to a value indicates the factory default setting.	



Fax Setup

General Fax settings

Menu item	Description
Fax Name	Identify your fax machine.
Fax Number	Identify your fax number.
Fax ID <ul style="list-style-type: none"> Fax Name Fax Number* 	Notify fax recipients of your fax name or fax number.
Memory Use <ul style="list-style-type: none"> All receive Mostly receive Equal* Mostly send All send 	Set the amount of internal printer memory allocated for faxing.  Note: This menu item prevents memory buffer conditions and failed faxes.
Cancel Faxes <ul style="list-style-type: none"> Allow* Don't Allow 	Cancel outgoing faxes before they are transmitted, or cancel incoming faxes before they finish printing.
Fax Number Masking <ul style="list-style-type: none"> Off* From Left From Right 	Specify the format for masking an outgoing fax number.
Digits to Mask 0–58 (0*)	Specify the number of digits to mask in an outgoing fax number.

Menu item	Description
Enable Line Connected Detection <ul style="list-style-type: none"> • On* • Off 	Determine whether a telephone line is connected to the printer.  Note: Detection takes place when turning on the printer and before each call.
Optimize Fax Compatibility	Configure the printer fax functionality for optimal compatibility with other fax machines.
 Note: An asterisk (*) next to a value indicates the factory default setting.	

Fax Send Settings

Menu item	Description
Resolution <ul style="list-style-type: none"> • Standard* • Fine • Super Fine • Ultra Fine 	Set the resolution of the scanned image.  Note: A higher resolution increases fax transmission time and requires higher memory.
Original Size [List of paper sizes] (Mixed Sizes*)	Specify the size of the original document.
Orientation <ul style="list-style-type: none"> • Portrait* • Landscape 	Specify the orientation of the original document.  Note: This menu item appears only in some printer models.
Content Type <ul style="list-style-type: none"> • Text* • Text/Photo • Photo • Graphics 	Improve the output result based on the content of the original document.
Darkness 1–9 (5*)	Adjust the darkness of the scanned image.
Behind a PABX <ul style="list-style-type: none"> • On • Off* 	Set the printer to dial a fax number without waiting to recognize the dial tone.  Note: Private Automated Branch Exchange (PABX) is a telephone network that allows a single access number to offer multiple lines to outside callers.

Use printer menus

Menu item	Description
Dial Mode <ul style="list-style-type: none">• Tone*• Pulse	Specify the dial mode for incoming or outgoing faxes.
 Note: An asterisk (*) next to a value indicates the factory default setting.	

Advanced Imaging

Menu item	Description
Contrast <ul style="list-style-type: none">• Best for Content*• 0• 1• 2• 3• 4• 5	Set the contrast of the output.
Background Removal <ul style="list-style-type: none">• Level• -4 to 4 (0*)	Adjust the amount of background visible on a scanned image.
Scan Edge to Edge <ul style="list-style-type: none">• On• Off*	Allow edge-to-edge scanning of the original document.
 Note: An asterisk (*) next to a value indicates the factory default setting.	

Admin Controls

Menu item	Description
Automatic Redial 0–9 (5*)	Adjust the number of redial attempts based on the activity levels of recipient fax machines.
Redial Frequency 1–200 minutes (3*)	Increase the time between redial attempts to increase the chance of sending fax successfully.
Enable ECM <ul style="list-style-type: none">• On*• Off	Activate Error Correction Mode (ECM) for fax jobs.  Note: ECM detects and corrects errors in the fax transmission process caused by telephone line noise and poor signal strength.

Menu item	Description
Enable Fax Scans <ul style="list-style-type: none"> On* Off 	Fax documents that are scanned at the printer.
Driver to Fax <ul style="list-style-type: none"> On* Off 	Allow the print driver to send fax.
Allow Save as Shortcut <ul style="list-style-type: none"> On* Off 	Save fax numbers as shortcuts on the printer.
Max Speed <ul style="list-style-type: none"> 33600* 14400 9600 4800 2400 	Set the maximum speed for sending fax.
Enable Color Fax Scans <ul style="list-style-type: none"> Off by Default* On by Default Never Use Always Use 	Enable color scans for fax.
Auto Convert Color Faxes to Mono Faxes <ul style="list-style-type: none"> On* Off 	Convert all outgoing color faxes to black and white.
Confirm Fax Number <ul style="list-style-type: none"> On* Off 	Ask the user to confirm the fax number.
Dial Prefix	Set a dialing prefix.
 Note: An asterisk (*) next to a value indicates the factory default setting.	

Fax Receive Settings



Menu item	Description
Rings to Answer 1–25 (3*)	Set the number of rings for incoming fax.
Auto Reduction <ul style="list-style-type: none"> On* Off 	Scale incoming fax to fit on the page.

Use printer menus

Menu item	Description
Paper Source <ul style="list-style-type: none"> • Tray [X] • Auto* 	Set the paper source for printing incoming fax.
Separator Sheets <ul style="list-style-type: none"> • None* • Before Job • After Job 	Specify whether to insert blank separator sheets when printing.
Separator Sheet Source Tray [X] (1*)	Specify the paper source for the separator sheet.
Fax Footer <ul style="list-style-type: none"> • On • Off* 	Print the transmission information at the bottom of each page from a received fax.
Fax Footer Time Stamp <ul style="list-style-type: none"> • Receive* • Print 	Print the time stamp at the bottom of each page from a received fax.
 Note: An asterisk (*) next to a value indicates the factory default setting.	

Admin Controls

Menu item	Description
Enable Fax Receive <ul style="list-style-type: none"> • On* • Off 	Set the printer to receive fax.
Enable Color Fax Receive <ul style="list-style-type: none"> • On* • Off 	Set the printer to receive fax in color.
Enable Caller ID <ul style="list-style-type: none"> • On* • Off 	Show the number that is sending the incoming fax.
Block No Name Fax <ul style="list-style-type: none"> • On* • Off 	Block incoming faxes sent from devices with no station ID or fax ID specified.
Answer On <ul style="list-style-type: none"> • All Rings* • Single Ring Only • Double Ring Only • Triple Ring Only • Single or Double Rings Only • Single or Triple Rings Only 	Set a distinctive ring pattern for incoming fax.

Menu item	Description
<ul style="list-style-type: none"> • Double or Triple Rings Only 	
Auto Answer <ul style="list-style-type: none"> • On* • Off 	Set the printer to receive fax automatically.
Fax Forwarding <ul style="list-style-type: none"> • Print* • Print and Forward • Forward 	Specify whether to forward received fax.
Forward To <ul style="list-style-type: none"> • Destination 1 • Destination 2 	Specify where to forward received fax.  Note: This menu item appears only when Fax Forwarding is set to Print and Forward or Forward.
Max Speed <ul style="list-style-type: none"> • 33600* • 14400 • 9600 • 4800 • 2400 	Set the maximum speed for transmitting fax.
 Note: An asterisk (*) next to a value indicates the factory default setting.	

Fax Log settings

Menu item	Description
Transmission Log Frequency <ul style="list-style-type: none"> • Always* • Never • Only for Error 	Specify how often the printer creates a transmission log.
Transmission Log Action <ul style="list-style-type: none"> • Print • Off • On* • E-mail • Off* • On 	Print or e-mail a log for successful fax transmission or transmission error.
Receive Error Log <ul style="list-style-type: none"> • Print Never* • Print on Error 	Print a log for fax-receive failures.
Auto Print Logs <ul style="list-style-type: none"> • On* • Off 	Print all fax activity.

Use printer menus

Menu item	Description
Log Paper Source Tray [x] (1*)	Specify the paper source for printing logs.
Logs Display <ul style="list-style-type: none">• Remote Fax Name*• Dialed Number	Identify the sender by remote fax name or fax number.
Enable Job Log <ul style="list-style-type: none">• On*• Off	View a summary of all fax jobs.
Enable Call Log <ul style="list-style-type: none">• On*• Off	View a summary of fax dialing history.

 **Note:** An asterisk (*) next to a value indicates the factory default setting.

Speaker settings

Menu item	Description
Speaker Mode <ul style="list-style-type: none">• Always Off*• Always On• On until Connected	Set the fax speaker mode.
Speaker Volume <ul style="list-style-type: none">• Low*• High	Adjust the fax speaker volume.
Ringer Volume <ul style="list-style-type: none">• Off*• On	Enable the ringer volume.

 **Note:** An asterisk (*) next to a value indicates the factory default setting.

E-mail



E-mail Setup

Menu item	Description
Primary SMTP Gateway	Type the IP address or host name of the primary SMTP server for sending e-mail.
Primary SMTP Gateway Port 1–65535 (25*)	Enter the port number of the primary SMTP server.
Secondary SMTP Gateway	Type the server IP address or host name of your secondary or backup SMTP server.
Secondary SMTP Gateway Port 1–65535 (25*)	Enter the server port number of your secondary or backup SMTP server.
SMTP Timeout 5–30 seconds (30*)	Set the time before the printer times out if the SMTP server does not respond.
Reply Address	Specify a reply address in the e-mail.
Always use SMTP default Reply Address <ul style="list-style-type: none"> • Off* • On 	Always use the default reply address in the SMTP server.
Use SSL/TLS <ul style="list-style-type: none"> • Disabled* • Negotiate • Required 	Specify whether to send e-mail using an encrypted link.
Require Trusted Certificate <ul style="list-style-type: none"> • Off • On* 	Require a trusted certificate when accessing the SMTP server.
SMTP Server Authentication <ul style="list-style-type: none"> • No authentication required* • Login / Plain • NTLM • CRAM-MD5 • Digest-MD5 	Set the authentication type for the SMTP server.
Device-Initiated E-mail <ul style="list-style-type: none"> • None* • Use Device SMTP Credentials 	Specify whether credentials are required for device-initiated e-mail.

Menu item	Description
Device Userid	Specify the user ID and password to connect to the SMTP server.
Device Password	
NTLM Domain	Specify the domain name for the NTLM security protocol.
 Note: An asterisk (*) next to a value indicates the factory default setting.	

E-mail Defaults

Menu item	Description
Subject	Specify the e-mail subject and message.
Message	
File Name	Specify the filename for the scanned image.
Format <ul style="list-style-type: none"> • PDF (.pdf)* • TIFF (.tif) • JPEG (.jpg) 	Specify the file format for the scanned image.
PDF Settings <ul style="list-style-type: none"> • PDF Version <ul style="list-style-type: none"> – 1.3 – 1.4 – 1.5* – 1.6 – 1.7 • Archival Version <ul style="list-style-type: none"> – A-1a* – A-1b • Secure <ul style="list-style-type: none"> – Off* – On • Archival (PDF/A) <ul style="list-style-type: none"> – Off* – On 	Set the PDF format of the scanned image.  Note: Archival Version and Archival (PDF/A) appear only if PDF Version is set to 1.4.
Content Type <ul style="list-style-type: none"> • Text 	Improve the output result based on the content of the original document.



Menu item	Description
<ul style="list-style-type: none"> • Text/Photo* • Photo • Graphics 	
Color <ul style="list-style-type: none"> • Black and White • Gray • Color* • Auto 	Specify the color when scanning an image.
Resolution <ul style="list-style-type: none"> • 75 dpi • 150 dpi* • 200 dpi • 300 dpi • 400 dpi • 600 dpi 	Set the resolution of the scanned image.
Darkness 1–9 (5*)	Adjust the darkness of the scanned image.
Orientation <ul style="list-style-type: none"> • Portrait* • Landscape 	Specify the orientation of the original document.  Note: This menu item appears only in some printer models.
Original Size [List of paper sizes]	Set the paper size of the original document.  Note: Mixed Sizes is the factory default setting.

Advanced Imaging

Menu item	Description
Contrast <ul style="list-style-type: none"> • Best for content* <ul style="list-style-type: none"> – 0 – 1 – 2 – 3 – 4 – 5 	Specify the contrast of the output.
Background Removal <ul style="list-style-type: none"> • Level • -4 to 4 (0*) 	Adjust the amount of background visible on a scanned image.
Scan Edge to Edge <ul style="list-style-type: none"> • On • Off* 	Allow edge-to-edge scanning of the original document.

Admin Controls



Menu item	Description
Max E-mail Size 0–65535 (0*)	Set the allowable file size for each e-mail.
Size Error Message	Specify an error message that the printer sends when an e-mail exceeds its allowable file size. You can type up to 1024 characters.
Send Me a Copy <ul style="list-style-type: none"> • Never appears* • On by Default • Off by Default • Always On 	Send a copy of the e-mail to yourself.
Text Default 5–95 (75*)	Set the quality of text on a scanned image.
Text/Photo Default 5–95 (75*)	Set the quality of text or photo on a scanned image.
Photo Default 5–95 (50*)	Set the quality of a photo on a scanned image.

Menu item	Description
Transmission Log <ul style="list-style-type: none"> • Print log* • Do Not Print Log • Print Only For Error 	Print a log for successful e-mail transmission.
Log Paper Source Tray [x] (1*)	Specify the paper source for printing logs.
Allow Save as Shortcut <ul style="list-style-type: none"> • On* • Off 	Save e-mail addresses as shortcuts.  Note: When set to Off, the Save As Shortcut button does not appear on the e-mail Destination screen.
Reset E-mail Information After Sending <ul style="list-style-type: none"> • On* • Off 	Restore the default e-mail information after sending an e-mail.
 Note: An asterisk (*) next to a value indicates the factory default setting.	

FTP

FTP Defaults

Menu item	Description
Format <ul style="list-style-type: none"> • PDF (.pdf)* • TIFF (.tif) • JPEG (.jpg) 	Specify the file format for the scanned image.
PDF Settings <ul style="list-style-type: none"> • PDF Version <ul style="list-style-type: none"> – 1.3 – 1.4 – 1.5* – 1.6 – 1.7 • Archival Version <ul style="list-style-type: none"> – A-1a* – A-1b • Secure <ul style="list-style-type: none"> – Off* – On • Archival (PDF/A) <ul style="list-style-type: none"> – Off* – On 	Set the PDF format for the scanned image.  Note: Archival Version and Archival (PDF/A) appear only if PDF Version is set to 1.4.
Content Type <ul style="list-style-type: none"> • Text • Text/Photo* • Photo • Graphics 	Improve the output result based on the content of the original document.
Color <ul style="list-style-type: none"> • Black and White • Gray • Color* • Auto 	Specify the color when scanning an image.
Resolution <ul style="list-style-type: none"> • 75 dpi • 150 dpi* • 200 dpi • 300 dpi 	Set the resolution of the scanned image.

Menu item	Description
<ul style="list-style-type: none"> • 400 dpi • 600 dpi 	
Darkness 1–9 (5*)	Adjust the darkness of the scanned image.
Orientation <ul style="list-style-type: none"> • Portrait* • Landscape 	Specify the orientation of the original document.  Note: This menu item appears only in some printer models.
Original Size [List of paper sizes] (Mixed Sizes*)	Set the paper size of the original document.
File Name	Specify the file name of the scanned image.
 Note: An asterisk (*) next to a value indicates the factory default setting.	

Advanced Imaging

Menu item	Description
Color Balance <ul style="list-style-type: none"> • Cyan - Red <ul style="list-style-type: none"> – -4 to 4 (0*) • Magenta - Green <ul style="list-style-type: none"> – -4 to 4 (0*) • Yellow - Blue <ul style="list-style-type: none"> – -4 to 4 (0*) 	Adjust the color intensity during scanning.
Auto Color Detect <ul style="list-style-type: none"> • Color Sensitivity <ul style="list-style-type: none"> – 1–9 (5*) • Area Sensitivity <ul style="list-style-type: none"> – 1–9 (5*) • FTP Bit Depth <ul style="list-style-type: none"> – 1 bit* – 8 bit • Minimum Scan Resolution <ul style="list-style-type: none"> – 75 dpi – 150 dpi 	Set the amount of color that the printer detects from the original document.

Use printer menus

Menu item	Description
<ul style="list-style-type: none"> - 200 dpi - 300 dpi* 	
Contrast <ul style="list-style-type: none"> • Best for content* <ul style="list-style-type: none"> - 0 - 1 - 2 - 3 - 4 - 5 	Specify the contrast of the output.
Background Removal <ul style="list-style-type: none"> • Level • -4 to 4 (0*) 	Adjust the amount of background visible on a scanned image.
Scan Edge to Edge <ul style="list-style-type: none"> • On • Off* 	Allow edge-to-edge scanning of the original document.
 Note: An asterisk (*) next to a value indicates the factory default setting.	

Admin Controls



Menu item	Description
Text Default 5–95 (75*)	Set the quality of text on a scanned image.
Text/Photo Default 5–95 (75*)	Set the quality of text or photo image on a scanned image.
Photo Default 5–95(50*)	Set the quality of a photo image on a scanned image.
Transmission Log <ul style="list-style-type: none"> • Print log* • Do Not Print Log • Print Only For Error 	Print a log for successful FTP scan transmission.
Log Paper Source Tray [x] (1*)	Specify the paper source for printing FTP logs.
 Note: An asterisk (*) next to a value indicates the factory default setting.	

USB Drive

Flash Drive Scan

Menu item	Description
Format <ul style="list-style-type: none"> • PDF (.pdf)* • TIFF (.tif) • JPEG (.jpg) 	Specify the file format for the scanned image.
PDF Settings <ul style="list-style-type: none"> • PDF Version <ul style="list-style-type: none"> – 1.3 – 1.4 – 1.5* – 1.6 – 1.7 • Archival Version <ul style="list-style-type: none"> – A-1a* – A-1b • Secure <ul style="list-style-type: none"> – Off* – On • Archival (PDF/A) <ul style="list-style-type: none"> – Off* – On 	Set the PDF format for the scanned image.  Note: Archival Version and Archival (PDF/A) appear only if PDF Version is set to 1.4.
Content Type <ul style="list-style-type: none"> • Text • Text/Photo* • Photo • Graphics 	Improve the output result based on the content of the original document.
Color <ul style="list-style-type: none"> • Black and White • Gray • Color* • Auto 	Specify the color when scanning an image.
Resolution <ul style="list-style-type: none"> • 75 dpi • 150 dpi* • 200 dpi • 300 dpi 	Set the resolution of the scanned image.

Use printer menus

Menu item	Description
<ul style="list-style-type: none"> • 400 dpi • 600 dpi 	
Darkness 1–9 (5*)	Adjust the darkness of the scanned image.
Orientation <ul style="list-style-type: none"> • Portrait* • Landscape 	Specify the orientation of the original document.  Note: This menu item is available only in some printer models.
Original Size [List of paper sizes] (Mixed Sizes*)	Set the paper size of the original document.
File Name	Specify the file name of the scanned image.
 Note: An asterisk (*) next to a value indicates the factory default setting.	

Advanced Imaging

Menu item	Description
Contrast <ul style="list-style-type: none"> • Best for content* <ul style="list-style-type: none"> – 0 – 1 – 2 – 3 – 4 – 5 	Specify the contrast of the output.
Background Removal <ul style="list-style-type: none"> • Level • -4 to 4 (0*) 	Adjust the amount of background visible on a scanned image.
Scan Edge to Edge <ul style="list-style-type: none"> • On • Off* 	Allow edge-to-edge scanning of the original document.
 Note: An asterisk (*) next to a value indicates the factory default setting.	



Admin Controls

Menu item	Description
Text Default 5–95 (75*)	Set the quality of text on a scanned image.
Text/Photo Default 5–95 (75*)	Set the quality of text or photo on a scanned image.
Photo Default 5–95 (50*)	Set the quality of a photo on a scanned image.
 Note: An asterisk (*) next to a value indicates the factory default setting.	

Flash Drive Print



Menu item	Description
Number of Copies 1–9999 (1*)	Set the number of copies.
Paper Source <ul style="list-style-type: none"> • Tray [x] (1*) • Manual Paper • Manual Envelope 	Set the paper source for the print job.
Collate <ul style="list-style-type: none"> • (1,1,1) (2,2,2) • (1,2,3) (1,2,3)* 	Print multiple copies in sequence.
Sides <ul style="list-style-type: none"> • 1-Sided* • 2-Sided 	Specify whether to print on one side or two sides of the paper.
Flip Style <ul style="list-style-type: none"> • Long Edge* • Short Edge 	Determine which side of the paper (long edge or short edge) is bound when performing two-sided printing.  Note: Depending on the option selected, the printer automatically offsets each printed information of the page to bind the job correctly.
Pages per Side <ul style="list-style-type: none"> • Off* • 2 pages per side • 3 pages per side • 4 pages per side • 6 pages per side 	Print multiple page images on one side of a sheet of paper.

Use printer menus





Menu item	Description
<ul style="list-style-type: none"> • 9 pages per side • 12 pages per side • 16 pages per side 	
Pages per Side Ordering <ul style="list-style-type: none"> • Horizontal* • Reverse Horizontal • Reverse Vertical • Vertical 	Specify the positioning of multiple page images when using Pages per Side.  Note: The positioning depends on the number of page images and their page orientation.
Pages per Side Orientation <ul style="list-style-type: none"> • Auto* • Landscape • Portrait 	Specify the orientation of a multiple-page document when using Pages per Side.
Pages per Side Border <ul style="list-style-type: none"> • None* • Solid 	Print a border around each page image when using Pages per Side.
Separator Sheets <ul style="list-style-type: none"> • Off* • Between Copies • Between Jobs • Between Pages 	Specify whether to insert blank separator sheets when printing.
Separator Sheet Source Tray 1	Specify the paper source for the separator sheet.
Blank Pages <ul style="list-style-type: none"> • Do Not Print* • Print 	Specify whether to print blank pages in a print job.
 Note: An asterisk (*) next to a value indicates the factory default setting.	







Network/Ports

Network Overview



Menu item	Description
Active Adapter <ul style="list-style-type: none"> • Auto* • Standard Network • Wireless 	Specify the type of the network connection.
Network Status	Show the connectivity status of the printer network.
Display Network Status on Printer <ul style="list-style-type: none"> • On* • Off 	Show the network status on the display.
Speed, Duplex	Show the speed of the currently active network card.
IPv4	Show the IPv4 address.
All IPv6 Addresses	Show all IPv6 addresses.
Reset Print Server Start	Reset all active network connections to the printer.  Note: This setting removes all network configuration settings.
Network Job Timeout <ul style="list-style-type: none"> • Disabled • Enabled* 	Set the time before the printer cancels a network print job.
Network Job Timeout Time	Specify the timeout value (in seconds) when the Network Job Timeout setting is enabled.  Note: This feature is available only in some printer models.
Banner Page <ul style="list-style-type: none"> • Off* • On 	Print a banner page.
Scan to PC Port Range	Specify a valid port range for printers that are behind a port blocking firewall.
Enable Network Connections <ul style="list-style-type: none"> • Enable* • Disable 	Enable or disable all network connections.
Enable LLDP <ul style="list-style-type: none"> • Off* • On 	Enable Link Layer Discovery Protocol (LLDP) in the printer.
 Note: An asterisk (*) next to a value indicates the factory default setting.	

Wireless



Menu item	Description
Setup On Printer Panel <ul style="list-style-type: none"> • Choose Network • Add Wi-Fi Network <ul style="list-style-type: none"> – Network Name – Network Mode – Wireless Security Mode (Disabled*) 	Determine the wireless network that the printer connects to.  Note: This menu item appears as <i>Wireless Connection Setup</i> in the Embedded Web Server.
Wi-Fi Protected Setup <ul style="list-style-type: none"> • Start Push Button Method • Start PIN Method 	Establish a wireless network and enable network security. <ul style="list-style-type: none"> • Start Push Button Method connects the printer to a wireless network when buttons on both the printer and the access point (wireless router) are pressed within a given time. • Start PIN Method connects the printer to a wireless network when a PIN on the printer is entered into the wireless settings of the access point.
Compatibility 802.11b/g/n (2.4GHz)*	Specify the wireless standard for the wireless network.
Wireless Security Mode Disabled* WEP WPA2/WPA-Personal WPA2-Personal 802.1x - RADIUS	Set the type of security for connecting the printer to wireless devices.
WEP Authentication Mode Auto* Open Shared	Set the type of Wireless Encryption Protocol (WEP) used by the printer.  Note: This menu item appears only if Wireless Security Mode is set to WEP.
Set WEP Key	Specify a WEP password for secure wireless connection.  Note: This menu item appears only if Wireless Security Mode is set to WEP.
WPA2-Personal AES*	Enable wireless security through WPA2.  Note: This menu item appears only if Wireless Security Mode is set to WPA2-Personal.
Set PSK	Set the password for secure wireless connection.

Menu item	Description
	 Note: This menu item appears only if Wireless Security Mode is set to WPA2/WPA-Personal or WPA2-Personal.
WPA2/WPA-Personal AES*	Enable wireless security through WPA2/WPA.  Note: This menu item appears only if Wireless Security Mode is set to WPA2/WPA-Personal.
802.1x Encryption Mode <ul style="list-style-type: none"> • WPA+ • WPA2* 	Enable wireless security through 802.1x standard.  Note: This menu item appears only if Wireless Security Mode is set to 802.1x - Radius.
IPv4 <ul style="list-style-type: none"> • Enable DHCP • Off • On* 	Enable Dynamic Host Configuration Protocol (DHCP).  Note: DHCP is a standard protocol that lets a server dynamically assign an IP address and other network configuration parameters to each device on the network, so that they can communicate with other IP networks.
IPv4 <ul style="list-style-type: none"> • Set Static IP Address • IP Address • Netmask • Gateway 	Set the static IP address of your printer.
IPv6 <ul style="list-style-type: none"> • Enable IPv6 • Off • On* 	Enable IPv6 in the printer.
IPv6 <ul style="list-style-type: none"> • Enable DHCPv6 • Off • On* 	Enable DHCPv6 in the printer.
IPv6 <ul style="list-style-type: none"> • Stateless Address Auto configuration • Off • On* 	Set the network adapter to accept the automatic IPv6 address configuration entries provided by a router.
IPv6 DNS Address	Specify the DNS server address.
IPv6 Manually Assigned IPV6	Assign the IPv6 address.  Note: This menu item appears only in some printer models.
IPv6 Manually Assigned IPV6 Router	Assign the IPv6 router address.  Note: This menu item appears only in some printer models.

Use printer menus

Menu item	Description
IPv6 Address Prefix 0–128 (64*)	Specify the address prefix.
IPv6 All IPv6 Addresses	Show all IPv6 addresses.
IPv6 All IPv6 Router Addresses	Show all IPv6 router addresses.
Network Address <ul style="list-style-type: none"> • UAA • LAA 	View the network addresses.
PCL SmartSwitch <ul style="list-style-type: none"> • On* • Off* 	Set the printer to switch automatically to PCL emulation when a print job requires it, regardless of the default printer language.  Note: If PCL SmartSwitch is off, then the printer does not examine incoming data and uses the default printer language specified in the Setup menu.
PS SmartSwitch <ul style="list-style-type: none"> • On* • Off* 	Set the printer to switch automatically to PS emulation when a print job requires it, regardless of the default printer language. <ul style="list-style-type: none"> • This menu item appears only in some printer models. • If PS SmartSwitch is off, then the printer does not examine incoming data and uses the default printer language specified in the Setup menu.
Mac Binary PS <ul style="list-style-type: none"> • Auto* • On • Off 	Set the printer to process Macintosh binary PostScript print jobs. <ul style="list-style-type: none"> • This menu item appears only in some printer models. • On processes raw binary PostScript print jobs. • Off filters print jobs using the standard protocol.
 Note: An asterisk (*) next to a value indicates the factory default setting.	



Wi-Fi Direct

Menu item	Description
Enable Wi-Fi Direct <ul style="list-style-type: none"> On Off* 	Set the printer to connect directly to Wi-Fi devices.
Wi-Fi Direct Name	Specify the name of the Wi-Fi Direct network.
Wi-Fi Direct Password	Set the password to authenticate and validate users on a Wi-Fi connection.
Show Password on Setup Page <ul style="list-style-type: none"> Off On* 	Show the Wi-Fi Direct Password on the Network Setup Page.
Preferred Channel Number <ul style="list-style-type: none"> 1–11 Auto* 	Set the preferred channel of the Wi-Fi network.
Group Owner IP Address	Specify the IP address of the group owner.
Auto-Accept Push Button Requests <ul style="list-style-type: none"> Off* On 	Accept requests to connect to the network automatically.  Note: Accepting clients automatically is not secured.
 Note: An asterisk (*) next to a value indicates the factory default setting.	

Ethernet

Menu item	Description
Network Speed	Show the speed of an active network adapter.
IPv4 <ul style="list-style-type: none"> Enable DHCP On* Off 	Enable Dynamic Host Configuration Protocol (DHCP).  Note: DHCP is a standard protocol that allows a server to distribute IP addressing and configuration information dynamically to clients.
IPv4 <ul style="list-style-type: none"> Set Static IP Address IP Address Netmask Gateway 	Set the static IP address of your printer.



Use printer menus

Menu item	Description
IPv6 <ul style="list-style-type: none"> • Enable IPv6 • Off • On* 	Enable IPv6 in the printer.
IPv6 <ul style="list-style-type: none"> • Enable DHCPv6 • Off • On* 	Enable DHCPv6 in the printer.
IPv6 <ul style="list-style-type: none"> • Stateless Address Auto configuration • On* • Off 	Set the network adapter to accept the automatic IPv6 address configuration entries provided by a router.
IPv6 DNS Address	Specify the DNS server address.
IPv6 Manually Assigned IPv6 Address	Specify IP address for the IPv6 DNS Server  Note: This menu item appears only in some printer models.
IPv6 Manually Assigned IPv6 Router	Specify the router for IPv6 network.  Note: This menu item appears only in some printer models.
IPv6 Address Prefix 0–128 (64*)	Specify the address prefix.
IPv6 All IPv6 Addresses	Show all IPv6 addresses.
IPv6 All IPv6 Router Addresses	Show all IPv6 router addresses.
Network Address <ul style="list-style-type: none"> • UAA • LAA 	Show the printer Media Access Control (MAC) addresses: Locally Administered Address (LAA) and Universally Administered Address (UAA).  Note: You can change the printer LAA manually.
PCL SmartSwitch <ul style="list-style-type: none"> • On* • Off* 	Set the printer to switch automatically to PCL emulation when a print job requires it, regardless of the default printer language. <ul style="list-style-type: none"> • This menu item is available only in some printer models.



Menu item	Description
	<ul style="list-style-type: none"> If PCL SmartSwitch is off, then the printer does not examine incoming data and uses the default printer language specified in the Setup menu.
PS SmartSwitch <ul style="list-style-type: none"> On* Off* 	<p>Set the printer to switch automatically to PS emulation when a print job requires it, regardless of the default printer language.</p> <ul style="list-style-type: none"> This menu item is available only in some printer models. If PS SmartSwitch is off, then the printer does not examine incoming data and uses the default printer language specified in the Setup menu.
Mac Binary PS <ul style="list-style-type: none"> Auto* On Off 	<p>Set the printer to process Macintosh binary PostScript print jobs.</p> <ul style="list-style-type: none"> On processes raw binary PostScript print jobs. Off filters print jobs using the standard protocol.
Energy Efficient Ethernet <ul style="list-style-type: none"> Auto* On Off 	<p>Reduce power consumption when the printer does not receive data from the Ethernet network.</p>
 Note: An asterisk (*) next to a value indicates the factory default setting.	

TCP/IP

 **Note:** This menu appears only in network printers or printers attached to print servers.

Menu item	Description
Set Hostname	Set the current TCP/IP host name.
Domain Name	<p>Set the domain name.</p>  Note: This menu item is available only in some printer models.
Allow DHCP/BOOTP to update NTP server <ul style="list-style-type: none"> On* Off 	<p>Allow the DHCP and BOOTP clients to update the NTP settings of the printer.</p>
Zero Configuration Name	<p>Specify a service name for the zero configuration network.</p>  Note: This menu item is available only in some printer models.

Use printer menus

Menu item	Description
Enable Auto IP <ul style="list-style-type: none"> • On* • Off 	Assign an IP address automatically.
DNS Address	Specify the current Domain Name System (DNS) server address.
Backup DNS	Specify the backup DNS server addresses.
Backup DNS 2	
Backup DNS 3	
Domain Search Order	Specify a list of domain names to locate the printer and its resources that reside in different domains on the network.  Note: This menu item is available only in some printer models.
Enable DDNS <ul style="list-style-type: none"> • Off* • On 	Update the Dynamic DNS settings.
DDNS TTL	Specify the current DDNS settings.
Default TTL	
DDNS Refresh Time	
Enable mDNS <ul style="list-style-type: none"> • On* • Off 	Update multicast DNS settings.
WINS Address	Specify a server address for Windows Internet Name Service (WINS).
Enable BOOTP <ul style="list-style-type: none"> • Off* • On 	Allow the BOOTP to assign a printer IP address.
MTU	Specify a maximum transmission unit (MTU) parameter for the TCP connections.  Note: The maximum limit is 1500.
Restricted Server List	Specify an IP address for the TCP connections. <ul style="list-style-type: none"> • This menu item appears only in the Embedded Web Server. • Use a comma to separate each IP address. • You can add up to 50 IP addresses.

Menu item	Description
	<ul style="list-style-type: none"> This menu item is available only in some printer models.
Restricted Server List Options <ul style="list-style-type: none"> Block All Ports* Block Printing Only Block Printing and HTTP Only 	Specify how the IP addresses in the list can access the printer functionality. <ul style="list-style-type: none"> This menu item appears only in the Embedded Web Server. This menu item is available only in some printer models.
Raw Print Port 1–65535 (9100*)	Specify a raw port number for printers connected on a network.
Outbound Traffic Maximum Speed <ul style="list-style-type: none"> Disabled* Enabled 	Enable the printer maximum transfer rate.
Enable TLSv1.0 <ul style="list-style-type: none"> On* Off 	Enable the TLSv1.0 protocol.
Enable TLSv1.1 <ul style="list-style-type: none"> On* Off 	Enable the TLSv1.1 protocol.
SSL Cipher List	Specify the cipher algorithms to use for the SSL or the TLS connections.
 Note: An asterisk (*) next to a value indicates the factory default setting.	

SNMP







 **Note:** This menu appears only in network printers or printers that are attached to print servers.

Use printer menus



Menu item	Description
<p>SNMP Versions 1 and 2c</p> <ul style="list-style-type: none"> • Enabled <ul style="list-style-type: none"> – Off – On* • Allow SNMP Set <ul style="list-style-type: none"> – Off – On* • Enable PPM MIB <ul style="list-style-type: none"> – Off – On* • SNMP Community 	<p>Configure Simple Network Management Protocol (SNMP) versions 1 and 2c to install print drivers and applications.</p>
<p>SNMP Version 3</p> <ul style="list-style-type: none"> • Enabled <ul style="list-style-type: none"> – Off – On* • Context Name • Set Read/Write Credentials <ul style="list-style-type: none"> – User Name – Authentication Password – Privacy Password • Set Read-only Credentials <ul style="list-style-type: none"> – User Name – Authentication Password – Privacy Password • Authentication Hash <ul style="list-style-type: none"> – MD5 – SHA1* • Minimum Authentication Level <ul style="list-style-type: none"> – No Authentication, No Privacy – Authentication, No Privacy – Authentication, Privacy* • Privacy Algorithm <ul style="list-style-type: none"> – DES – AES-128* 	<p>Configure SNMP version 3 to install and update the printer security.</p>
<p> Note: An asterisk (*) next to a value indicates the factory default setting.</p>	

IPSec

 **Note:** This menu appears only in network printers or printers that are attached to print servers.

Menu item	Description
Enable IPSec <ul style="list-style-type: none"> • Off* • On 	Enable Internet Protocol Security (IPSec).
Base Configuration <ul style="list-style-type: none"> • Default* • Compatibility • Secure 	Set the IPSec base configuration.  Note: This menu item appears only when Enable IPSec is set to On.
DH (Diffie-Hellman) Group Proposal <ul style="list-style-type: none"> • modp2048 (14)* • modp3072 (15) • modp4096 (16) • modp6144 (17) 	Set the IPSec encryption.  Note: This menu item appears only when Base Configuration is set to Compatibility.
Proposed Encryption Method <ul style="list-style-type: none"> • AES* • 3DES 	Specify an encryption method.  Note: This menu item appears only when Base Configuration is set to Compatibility.
Proposed Authentication Method <ul style="list-style-type: none"> • SHA256* • SHA512 • SHA1 	Specify an authentication method.  Note: This menu item appears only when Base Configuration is set to Compatibility.
IKE SA Lifetime (Hours) <ul style="list-style-type: none"> • -1 • -2 • -4 • -8 • -24 	Specify the IKE SA expiry period.  Note: This menu item appears only when Base Configuration is set to Secure.
IPSec SA Lifetime (Hours) <ul style="list-style-type: none"> • -1 • -2 • -4 • -8 • -24 	Specify the IPSec SA expiry period.  Note: This menu item appears only when Base Configuration is set to Secure.
IPSec Device Certificate default	Specify an IPSec certificate.  Note: This menu item appears only when Base Configuration is set to Compatibility or Secure.

Use printer menus

Menu item	Description
Pre-Shared Key Authenticated Connections <ul style="list-style-type: none">• Host [x]• Address• Key	Configure the authenticated connections of the printer.  Note: This menu item appears only when Enable IPSec is set to On.
Certificate Authenticated Connections <ul style="list-style-type: none">• Host [x] Address[/subnet]• Address[/subnet]	
 Note: An asterisk (*) next to a value indicates the factory default setting.	



802.1x



 **Note:** This menu appears only in network printers or printers that are attached to print servers.

Menu item	Description
Active <ul style="list-style-type: none">• Off*• On	Let the printer join networks that require authentication before allowing access.
 Note: An asterisk (*) next to a value indicates the factory default setting.	

LPD Configuration

 **Note:** This menu appears only in network printers or printers that are attached to print servers.

Menu item	Description
LPD Timeout 0–65535 seconds (90*)	Set the time-out value to stop the Line Printer Daemon (LPD) server from waiting indefinitely for hung or invalid print jobs.
LPD Banner Page <ul style="list-style-type: none">• Off*• On	Print a banner page for all LPD print jobs.  Note: A banner page is the first page of a print job used as a separator of print jobs and to identify the originator of the print job request.
LPD Trailer Page <ul style="list-style-type: none">• Off*• On	Print a trailer page for all LPD print jobs.  Note: A trailer page is the last page of a print job.

Menu item	Description
LPD Carriage Return Conversion <ul style="list-style-type: none"> Off* On 	Enable carriage return conversion.  Note: Carriage return is a mechanism that commands the printer to move the position of the cursor to the first position on the same line.
 Note: An asterisk (*) next to a value indicates the factory default setting.	

HTTP/FTP Settings



 **Note:** This menu appears only in network printers or printers that are attached to print servers.

Menu item	Description
Enable HTTP Server <ul style="list-style-type: none"> Off On* 	Access the Embedded Web Server to monitor and manage the printer.
Enable HTTPS <ul style="list-style-type: none"> Off* On 	Configure the Hypertext Transfer Protocol Secure (HTTPS) settings.
Force HTTPS Connections <ul style="list-style-type: none"> Off On* 	Force the printer to use the HTTPS connections.
Enable FTP/TFTP <ul style="list-style-type: none"> Off On* 	Send files using FTP.
HTTP Proxy IP Address	Configure the HTTP and FTP server settings.  Note: This feature is available only in some printer models.
FTP Proxy IP Address	
HTTP Default IP Port 1–65535 (80*)	
HTTPS Device Certificate	
FTP Default IP Port 1–65535 (21*)	
Timeout for HTTP/FTP Requests 1–299 (30*)	

Use printer menus

Menu item	Description
Retries for HTTP/FTP Requests 1–299 (3*)	Set the number of retries to connect to the HTTP/FTP server.
 Note: An asterisk (*) next to a value indicates the factory default setting.	

USB

Menu item	Description
PCL SmartSwitch <ul style="list-style-type: none"> Off On* 	Set the printer to switch to PCL emulation when a print job received through a USB port requires it, regardless of the default printer language.  Note: If PCL SmartSwitch is off, then the printer does not examine incoming data and uses the default printer language specified in the Setup menu.
PS SmartSwitch <ul style="list-style-type: none"> Off On* 	Set the printer to switch to PS emulation when a print job received through a USB port requires it, regardless of the default printer language.  Note: If PCL SmartSwitch is off, then the printer does not examine incoming data and uses the default printer language specified in the Setup menu.
Enable USB Port <ul style="list-style-type: none"> Enable* Disable 	Enable the standard USB port.
MAC Binary PS <ul style="list-style-type: none"> Auto On* Off 	Set the printer to process Macintosh binary PostScript print jobs. <ul style="list-style-type: none"> This menu item appears only in some printer models. On processes raw binary PostScript print jobs. Off filters print jobs using the standard protocol.
 Note: An asterisk (*) next to a value indicates the factory default setting.	

Restrict external network access

Menu item	Description
Restrict external network access <ul style="list-style-type: none"> • Off* • On 	Restrict access to network sites.
External network address	Specify the network addresses with restricted access.
E-mail address for notification	Specify an e-mail address to send a notification of logged events.
Ping frequency 1–300 (10*)	Specify the network query interval in seconds.
Subject	Specify the subject and message of the notification e-mail.
Message	
 Note: An asterisk (*) next to a value indicates the factory default setting.	

Use printer menus

Security

Login Methods

Public



Note: This menu can be configured only from the Embedded Web Server.

Menu item	Description
<p>Manage Permissions</p> <ul style="list-style-type: none"> • Function Access <ul style="list-style-type: none"> – Manage Shortcuts – Create Profiles – Flash Drive Print – Flash Drive Scan – Copy Function – E-mail Function – Fax Function – FTP Function – Release Held Faxes – Held Jobs Access – User Profiles – Cancel Jobs at the Device – Change Language – Internet Printing Protocol (IPP) – Initiate Scans Remotely – B/W Print – Network Folder - Scan 	<p>Control access to the printer functions.</p> <p> Note: Flash Drive Print and Flash Drive Scan are available only in some printer models.</p>
<p>Manage Permissions</p> <ul style="list-style-type: none"> • Administrative Menus <ul style="list-style-type: none"> – Security Menu – Network/Ports Menu – Paper Menu – Reports Menu – Function Configuration Menus – Supplies Menu – SE Menu – Device Menu 	<p>Control access to the printer menus.</p>
<p>Manage Permissions</p> <ul style="list-style-type: none"> • Device Management <ul style="list-style-type: none"> – Remote Management – Firmware Updates – Embedded Web Server Access – Import / Export All Settings – Out of Service Erase 	<p>Control access to the printer management options.</p>

Local Accounts

Menu item	Description
Add User <ul style="list-style-type: none"> • User Name/Password • User Name • Password • PIN 	Create local accounts to manage access to the printer functions.
Manage Groups/Permissions <ul style="list-style-type: none"> • Add Group <ul style="list-style-type: none"> – Import Access Controls <ul style="list-style-type: none"> – Function Access – Administrative Menus – Device Management • All Users <ul style="list-style-type: none"> – Import Access Controls <ul style="list-style-type: none"> – Function Access – Administrative Menus – Device Management • Admin <ul style="list-style-type: none"> – Function Access – Administrative Menus – Device Management 	Control group or user access to the printer functions, applications, and security settings.

Certificate Management

Menu item	Menu item
Configure Certificate Defaults <ul style="list-style-type: none"> • Common Name • Organization Name • Unit Name • Country/Region • Province Name • City Name • Subject Alternate Name 	Set the default values for generated certificates.
Device Certificates	Generate, delete, or view device certificates.
Manage CA Certificates	Load, delete, or view Certificate Authority (CA) certificates.

Schedule USB Devices

Menu item	Description
Schedules Add New Schedule	Schedule access to the front USB port.

Login Restrictions

Menu item	Description
Login failures 1–10 (3*)	Specify the number of failed login attempts before the user gets locked out.
Failure time frame 1–60 minutes (5*)	Specify the time frame between failed login attempts before the user gets locked out.
Lockout time 1–60 minutes (5*)	Specify the lockout duration.
Web Login Timeout 1–120 minutes (10*)	Specify the delay for a remote login before the user is logged off automatically.



Erase Temporary Data Files

Menu item	Description
Stored in onboard memory <ul style="list-style-type: none"> • Off* • On 	Delete all files stored on the printer memory.
 Note: An asterisk (*) next to a value indicates the factory default setting.	

Miscellaneous

Menu item	Description
Print Permission <ul style="list-style-type: none"> • Off* • On 	Allow the user to print.
Default Print Permission Login	Shows the default permission used for the user to print.

Use printer menus

Menu item	Description
	 Note: This setting shows only when one or more Login Methods are created.
Security Reset Jumper <ul style="list-style-type: none"> • Enable “Guest” access* • No Effect 	Specify user access to the printer. <ul style="list-style-type: none"> • The jumper is located beside a lock icon on the controller board. • Enable “Guest” access gives anyone access to all aspects of the printer. • No Effect may make access to the printer impossible when the required security information is unavailable.
Minimum Password Length 0–32	Specify the password length.
 Note: An asterisk (*) next to a value indicates the factory default setting.	

Reports

Menu Settings Page

Menu item	Description
Menu Settings Page	Print a report that contains the printer menus.

Device

Menu item	Description
Device Information	Print a report that contains information about the printer.
Device Statistics	Print a report about printer usage and supply status.
Profile List	Print a list of profiles that are stored in the printer.
Asset Report	Print a report that contains the printer serial number and model name.



Print

Menu item	Description
Print Fonts : PCL Fonts	Print samples and information about the fonts that are available in each printer language.



Shortcuts

Menu item	Description
All Shortcuts	Print a report that lists the shortcuts that are stored in the printer.
Fax Shortcuts	
Copy Shortcuts	
E-mail Shortcuts	
FTP Shortcuts	
Network Folder Shortcuts	

Fax

Menu item	Description
Fax Job Log	Print a report about the last 200 completed fax jobs.  Note: This menu item appears only when Enable Job Log is set to On.
Fax Call Log	Print a report about the last 100 attempted, received, and blocked calls.  Note: This menu item appears only when Enable Job Log is set to On.

Network

Menu item	Description
Network Setup Page	Print a page that shows the configured network and wireless settings on the printer.  Note: This menu item appears only in network printers or printers connected to print servers.
Wi-Fi Direct Connected Clients	Print a page that shows the list of devices that are connected to the printer using Wi-Fi Direct.  Note: This menu item appears only when Enable Wi-Fi Direct is set to On.

Troubleshooting

Menu item	Description
Print Quality Test Pages	Print sample pages to identify and correct print quality defects.
Cleaning the Scanner	Print instructions on how to clean the scanner.

Use printer menus

Maintain the Printer

This chapter contains:

- [Checking the Status of Supplies](#) 186
- [Configuring Supply Notifications](#)..... 187
- [Setting up e-mail alerts](#) 188
- [Viewing reports](#)..... 189
- [Ordering Supplies](#)..... 190
- [Replacing Supplies](#) 191
- [Cleaning printer parts](#) 196
- [Saving energy and paper](#) 199
- [Moving the Printer to Another Location](#)..... 200

Checking the Status of Supplies

1. From the control panel, navigate to: **Settings > Reports > Device > Device Statistics**
For non-touch-screen printer models, press OK to select each menu to navigate through the settings.
2. From the Supply Information section of the pages printed, check the status of supplies.

Configuring Supply Notifications

1. Open a web browser, and then type the printer IP address in the address field.
 - View the printer IP address on the printer home screen. The IP address appears as four sets of numbers separated by periods, such as 123.123.123.123.
 - If you are using a proxy server, then temporarily disable it to load the web page correctly.
2. Select an option:
 - If your printer has a control panel, click **Settings > OK > Device > OK > Notifications > OK**
 - If your printer has a touch screen, click **Settings > Device > Notifications**.
3. From the Supplies menu, click **Custom Supply Notifications**.
4. Select a notification for each supply item.
5. Apply the changes.

Setting up e-mail alerts

Configure the printer to send e-mail alerts when supplies are low, when paper must be changed or added, or when there is a paper jam.

1. Open a web browser, and then type the printer IP address in the address field.
 - View the printer IP address on the printer home screen. The IP address appears as four sets of numbers separated by periods, such as 123.123.123.123.
 - If you are using a proxy server, then temporarily disable it to load the web page correctly.
2. Click **Settings > Device > Notifications > E-mail Alert Setup**, and then configure the settings.



Note: For more information on SMTP settings, contact your e-mail provider.

3. Click **Setup E-mail Lists and Alerts**, and then configure the settings.
4. Apply the changes.

Viewing reports

1. From the control panel, navigate to:

Settings > Reports

For non-touch-screen printer models, press **OK** to navigate through the settings.

2. Select the report that you want to view.

Ordering Supplies

To view and order supplies for your printer, go to <https://www.xerox.com/supplies>, then enter your product in the search field.

 **Note:** All life estimates for printer supplies assume printing on letter or A4-size plain paper.

 **Warning:** Failure to maintain optimum printer performance or to replace supplies can cause damage to your printer.

Using Genuine Xerox Supplies

Your Xerox printer is designed to function best with genuine Xerox supplies. Use of third-party supplies can affect the performance, reliability, or life of the printer and its imaging components. It can also affect warranty coverage. Damage caused by the use of third-party supplies is not covered by the warranty.

All life indicators are designed to function with Xerox supplies and can deliver unpredictable results if third-party supplies are used. Imaging component usage beyond the intended life can damage your Xerox printer or associated components.

 **Warning:** Supplies without Return Program agreement terms can be reset and remanufactured. However, the manufacturer's warranty does not cover any damage caused by non-genuine supplies. Resetting counters on the supply without proper remanufacturing can cause damage to your printer. After resetting the supply counter, your printer may display an error indicating the presence of the reset item.

Replacing Supplies

Replacing the Toner Cartridge

1. Open the front door.

 **Warning:** To prevent damage from electrostatic discharge, touch any exposed metal frame of the printer before accessing or touching interior areas of the printer.

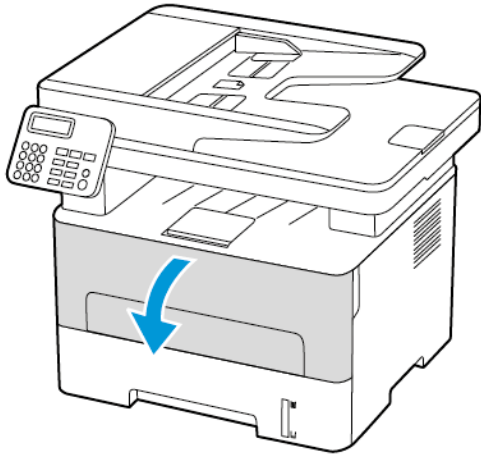

2. Remove the imaging unit.

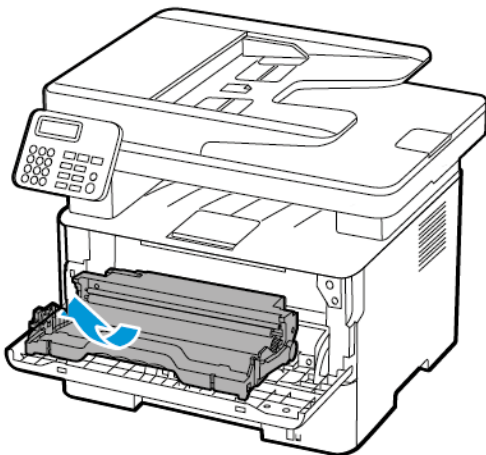

Maintain the Printer

3. Remove the used toner cartridge from the imaging unit.

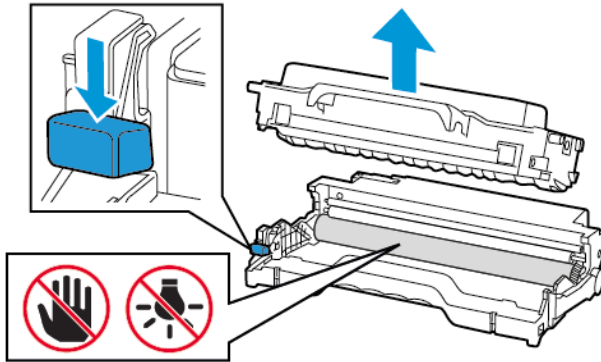

4. Unpack the new toner cartridge.
5. Shake the toner cartridge to redistribute the toner.

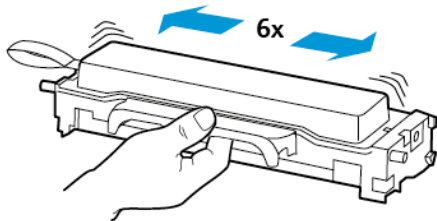

6. Remove the seal, and then remove the cover.

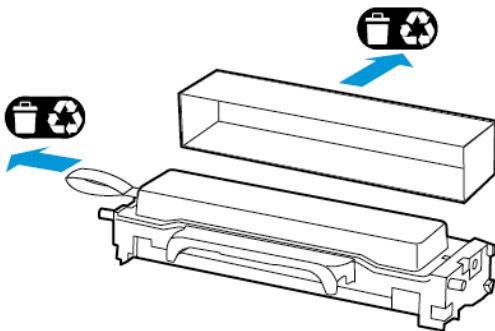

7. Insert the new toner cartridge into the imaging unit.

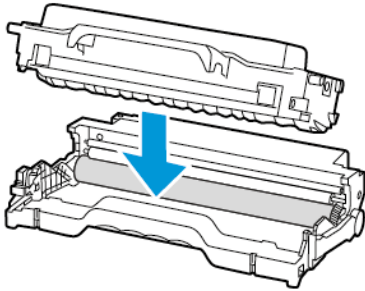

8. Insert the imaging unit.

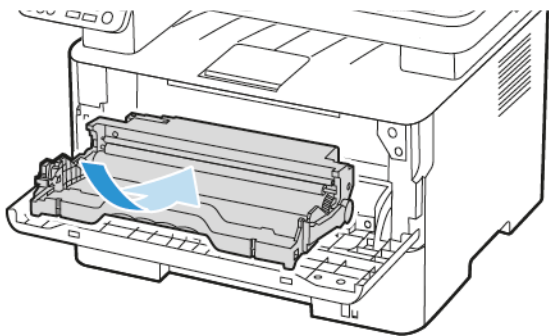

9. Close the door.

Replacing the imaging unit

1. Open the front door.

 **Warning:** To prevent damage from electrostatic discharge, touch any exposed metal frame of the printer before accessing or touching interior areas of the printer.

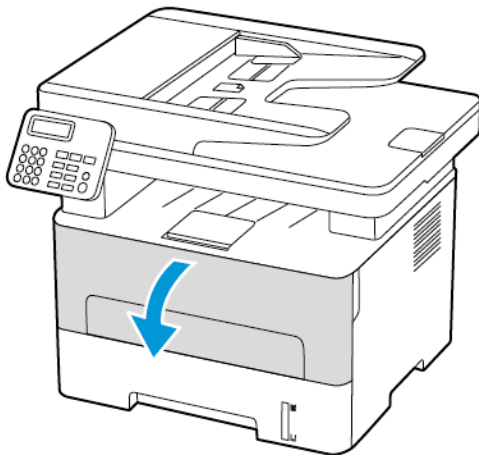

Maintain the Printer

2. Remove the used imaging unit.

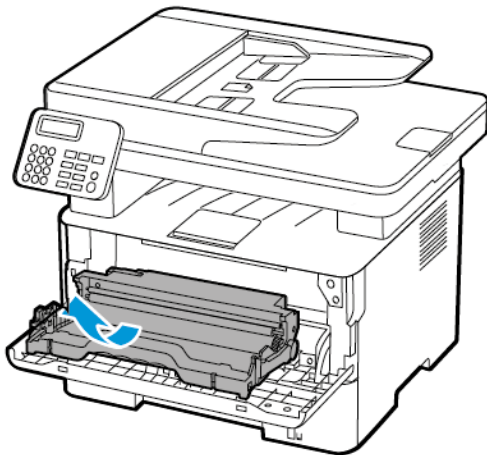

3. Remove the toner cartridge from the used imaging unit.

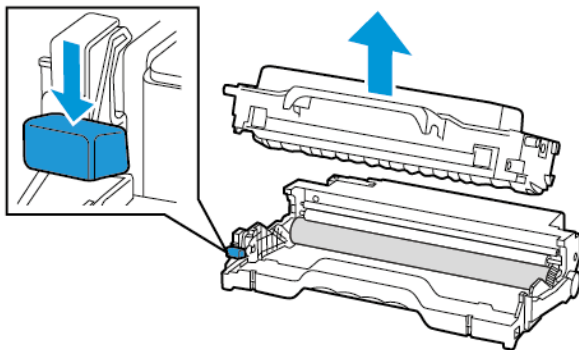

4. Unpack the new imaging unit, and then insert the toner cartridge.

 **Warning:** Do not expose the imaging unit to direct light for more than 10 minutes. Extended exposure to light may cause print quality problems.

 **Warning:** Do not touch the photoconductor drum. Doing so may affect the quality of future print jobs.

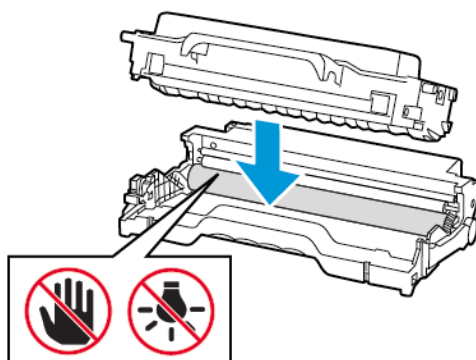

5. Insert the new imaging unit.

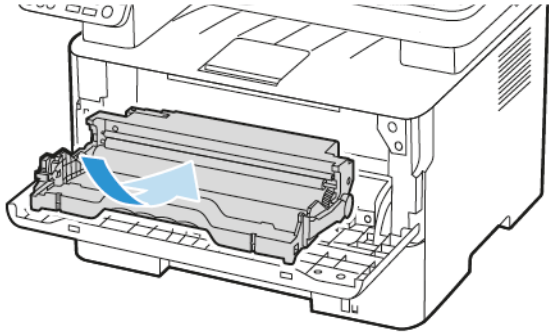

6. Close the door.

Cleaning printer parts

Cleaning the printer

 **CAUTION—SHOCK HAZARD:** To avoid the risk of electrical shock when cleaning the exterior of the printer, unplug the power cord from the electrical outlet and disconnect all cables from the printer before proceeding.

- Perform this task after every few months.
 - Damage to the printer caused by improper handling is not covered by the printer warranty.
1. Turn off the printer, and then unplug the power cord from the electrical outlet.
 2. Remove paper from the standard output tray.
 3. Remove any dust, lint, and pieces of paper around the printer using a soft brush or vacuum.
 4. Wipe the outside of the printer with a damp, soft, lint-free cloth.
 - Do not use household cleaners or detergents, as they may damage the finish of the printer.
 - Make sure that all areas of the printer are dry after cleaning.
 5. Connect the power cord to the electrical outlet, and then turn on the printer.

 **CAUTION—POTENTIAL INJURY:** To avoid the risk of fire or electrical shock, connect the power cord to an appropriately rated and properly grounded electrical outlet that is near the product and easily accessible.

Cleaning the touch screen

 **CAUTION—SHOCK HAZARD:** To avoid the risk of electric shock when cleaning the exterior of the printer, unplug the power cord from the electrical outlet and disconnect all cables from the printer before proceeding.

1. Turn off the printer, and then unplug the power cord from the electrical outlet.
2. Using a damp, soft, lint-free cloth, wipe the touch screen.
 - Do not use household cleaners or detergents, as they may damage the touch screen.
 - Make sure that the touch screen is dry after cleaning.
3. Connect the power cord to the electrical outlet, and then turn on the printer.

 **CAUTION—POTENTIAL INJURY:** To avoid the risk of fire or electrical shock, connect the power cord to an appropriately rated and properly grounded electrical outlet that is near the product and easily accessible.

Cleaning the Scanner

1. Open the scanner cover.

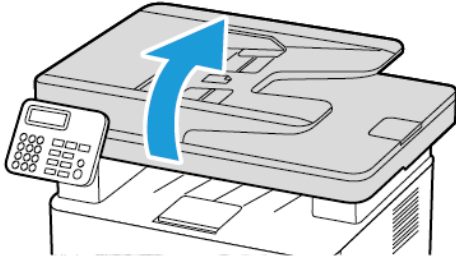

2. Using a damp, soft, lint-free cloth, wipe the following areas:

- a. ADF glass pad

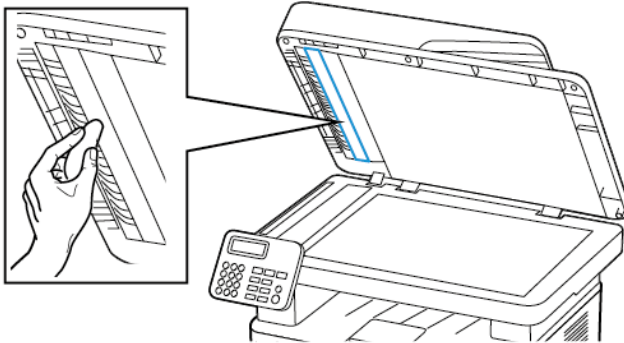

- b. Scanner glass pad

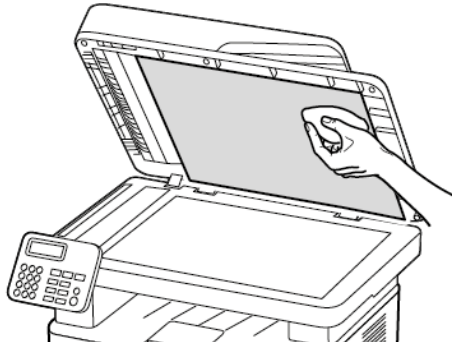

Maintain the Printer

c. ADF glass

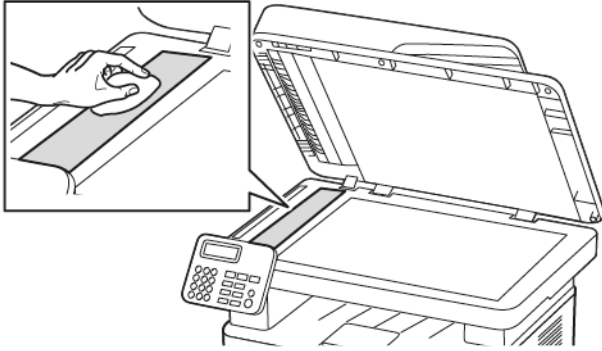

d. Scanner glass

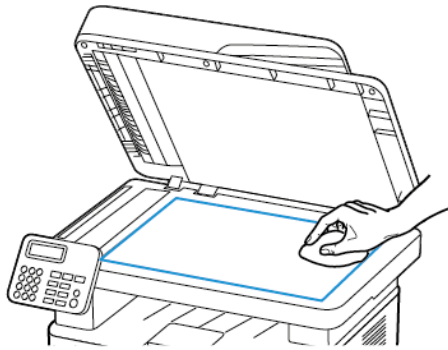

3. Close the scanner cover.

Saving energy and paper

Configuring power save mode settings

Sleep Mode

1. From the control panel, navigate to **Settings > Device > Power Management > Timeouts > Sleep Mode**.
For printers that use a control panel, press the **OK** button after selecting each menu option.
2. Enter the amount of time that the printer stays idle before it enters Sleep mode.

Hibernate Mode

1. From the control panel, navigate to **Settings > Device > Power Management > Timeouts > Hibernate Timeout**.
For printers that use a control panel, press the **OK** button after selecting each menu option.
2. Select the amount of time before the printer enters Hibernate mode.
 - Make sure to wake the printer from Hibernate mode before sending a print job.
 - To wake the printer from Hibernate mode, press the power button.
 - The Embedded Web Server is disabled when the printer is in Hibernate mode.

Adjusting the brightness of the display

 **Note:** This setting is available only in some printer models.

1. From the home screen, touch **Settings > Device > Preferences**.
2. In the Screen Brightness menu, adjust the setting.

Conserving supplies

- Print on both sides of the paper.

 **Note:** Two-sided printing is the default setting in the print driver.

- Print multiple pages on a single sheet of paper.
- Use the preview feature to see how the document looks like before printing it.
- Print one copy of the document to check its content and format for accuracy.

Moving the Printer to Another Location

 **CAUTION—POTENTIAL INJURY:** If the printer weight is greater than 20kg (44lb), then it may require two or more people to lift it safely.

 **CAUTION—POTENTIAL INJURY:** To avoid the risk of fire or electrical shock, use only the power cord provided with this product or the manufacturer's authorized replacement.

 **CAUTION—POTENTIAL INJURY:** When moving the printer, follow these guidelines to avoid personal injury or printer damage:

- Make sure that all doors and trays are closed.
- Turn off the printer, and then unplug the power cord from the electrical outlet.
- Disconnect all cords and cables from the printer.
- If the printer has separate floor-standing optional trays or output options attached to it, then disconnect them before moving the printer.
- If the printer has a caster base, then carefully roll it to the new location. Use caution when passing over thresholds and breaks in flooring.
- If the printer does not have a caster base but is configured with optional trays or output options, then remove the output options and lift the printer off the trays. Do not try to lift the printer and any options at the same time.
- Always use the handholds on the printer to lift it.
- Any cart used to move the printer must have a surface able to support the full footprint of the printer.
- Any cart used to move the hardware options must have a surface able to support the dimensions of the options.
- Keep the printer in an upright position.
- Avoid severe jarring movements.
- Make sure that your fingers are not under the printer when you set it down.
- Make sure that there is adequate clearance around the printer.

 **Note:** Damage to the printer caused by improper moving is not covered by the printer warranty.

Troubleshoot a problem

This chapter contains:

- Print quality problems 202
- Printing problems..... 203
- The printer is not responding 241
- Unable to read flash drive..... 243
- Enabling the USB port..... 244
- Network connection problems..... 245
- Issues with supplies..... 248
- Clearing Jams 250
- Paper feed problems 261
- E-mailing problems 265
- Faxing problems..... 266
- Scanning problems..... 271
- Contacting Customer Support 280

Print quality problems

Find the image that resembles the print quality problem you are having, and then click the link below it to read problem-solving steps.

- [Blank or White Pages](#)
- [Dark Print](#)
- [Fine lines are not printed correctly](#)
- [Folded or wrinkled paper](#)
- [Gray Background](#)
- [Horizontal light bands](#)
- [Incorrect margins](#)
- [Light print](#)
- [Mottled print and dots](#)
- [Paper curl](#)
- [Print crooked or skewed](#)
- [Repeating defects](#)
- [Solid black pages](#)
- [Text or images cut off](#)
- [Toner easily rubs off](#)
- [Vertical dark bands](#)
- [Vertical dark lines or streaks](#)
- [Vertical dark streaks with print missing](#)
- [Vertical white lines](#)
- [Vertical light bands](#)

Printing problems

Print quality is poor

Blank or White Pages



 **Note:** Before solving the problem, print the Print Quality Test Pages. From the control panel, navigate to **Settings > Troubleshooting > Print Quality Test Pages**. For non-touch-screen printer models, press **OK** to navigate through the settings.

Action	Yes	No
<p>Step 1</p> <p>a. Check if the printer is using a genuine and supported Xerox toner cartridge.</p> <p>If the cartridge is not supported, then install a supported one.</p> <p>b. Print the document.</p> <p>Is the printer printing blank or white pages?</p>	Go to step 2.	The problem is solved.
<p>Step 2</p> <p>a. Remove the imaging unit.</p> <p>Do not expose the imaging unit to direct light for more than 10 minutes. Extended exposure to light may cause print quality problems.</p> <p>Do not touch the photoconductor drum under the imaging unit. Doing so may affect the quality of future print jobs.</p> <p>b. Check the imaging unit for signs of damage.</p>	Go to step 3.	The problem is solved.

Troubleshoot a problem

Action	Yes	No
<p>Make sure that the photoconductor drum contact is not bent or out of place.</p> <p>c. Firmly shake the imaging unit to redistribute the toner.</p> <p>d. Insert the imaging unit.</p> <p>e. Print the document.</p> <p>Is the printer printing blank or white pages?</p>		
<p>Step 3</p> <p>Replace the toner cartridge.</p> <p>Is the printer printing blank or white pages?</p>	Go to step 4.	The problem is solved.
<p>Step 4</p> <p>Replace the imaging unit.</p> <p>Is the printer printing blank or white pages?</p>	Refer to Contacting Customer Support .	The problem is solved.

Dark Print



Note: Before solving the problem, print the Print Quality Test Pages. From the control panel, navigate to **Settings > Troubleshooting > Print Quality Test Pages**. For non-touch-screen printer models, press **OK** to navigate through the settings.

Action	Yes	No
<p>Step 1</p> <p>a. Check if the printer is using a genuine and supported Xerox toner cartridge.</p> <p>If the cartridge is not supported, then install a supported one.</p> <p>b. Print the document.</p> <p>Is the print dark?</p>	Go to step 2.	The problem is solved.
<p>Step 2</p> <p>a. Turn off the printer, wait for about 10 seconds, and then turn on the printer.</p> <p>b. Reduce toner darkness.</p> <p>From the control panel, navigate to:</p> <p>Settings > Print > Quality > Toner Darkness</p> <p>c. Print the document.</p> <p>Is the print dark?</p>	Go to step 3.	The problem is solved.
<p>Step 3</p> <p>a. Depending on your operating system, specify the paper type from the Printing Preferences or Print dialog.</p> <ul style="list-style-type: none"> • Make sure that the setting matches the paper loaded. • You can also change the setting on the printer control panel. Navigate to Settings > Paper > Tray Configuration > Paper Size/Type. <p>b. Print the document.</p> <p>Is the print dark?</p>	Go to step 4.	The problem is solved.
<p>Step 4</p> <p>Check if the paper has texture or rough finishes.</p> <p>Are you printing on textured or rough paper?</p>	Go to step 5.	Go to step 6.

Troubleshoot a problem

Action	Yes	No
<p>Step 5</p> <p>a. Replace textured paper with plain paper.</p> <p>b. Print the document.</p> <p>Is the print dark?</p>	Go to step 6.	The problem is solved.
<p>Step 6</p> <p>a. Load paper from a fresh package.</p> <p>Paper absorbs moisture due to high humidity. Store paper in its original wrapper until you are ready to use it.</p> <p>b. Print the document.</p> <p>Is the print dark?</p>	Go to step 7.	The problem is solved.
<p>Step 7</p> <p>a. Remove, and then insert the imaging unit.</p> <p>Do not expose the imaging unit to direct light for more than 10 minutes. Extended exposure to light may cause print quality problems.</p> <p>Do not touch the photoconductor drum under the imaging unit. Doing so may affect the quality of future print jobs.</p> <p>b. Print the document.</p> <p>Is the print dark?</p>	Go to step 8.	The problem is solved.
<p>Step 8</p> <p>a. Replace the imaging unit.</p> <p>b. Print the document.</p> <p>Is the print dark?</p>	Refer to Contacting Customer Support .	The problem is solved.

Fine lines are not printed correctly

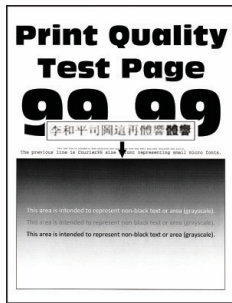

 **Note:** Before solving the problem, print the Print Quality Test Pages. From the control panel, navigate to **Settings > Troubleshooting > Print Quality Test Pages**. For non-touch-screen printer models, press **OK** to navigate through the settings.

Action	Yes	No
<p>Step 1</p> <p>a. Check if the printer is using a genuine and supported Xerox toner cartridge.</p> <p>If the cartridge is not supported, then install a supported one.</p> <p>b. Print the document.</p> <p>Are fine lines not printed correctly?</p>	<p>Go to step 2.</p>	<p>The problem is solved.</p>
<p>Step 2</p> <p>a. Increase toner darkness.</p> <p>From the control panel, navigate to: Settings > Print > Quality > Toner Darkness</p> <p>b. Print the document.</p> <p>Are fine lines not printed correctly?</p>	<p>Refer to Contacting Customer Support.</p>	<p>The problem is solved.</p>

Folded or wrinkled paper



 **Note:** Before solving the problem, print the Print Quality Test Pages. From the control panel, navigate to **Settings > Troubleshooting > Print Quality Test Pages**. For non-touch-screen printer models, press **OK** to navigate through the settings.

Action	Yes	No
<p>Step 1</p> <p>a. Check if the printer is using a genuine and supported Xerox toner cartridge.</p> <p>If the cartridge is not supported, then install a supported one.</p> <p>b. Print the document.</p> <p>Is the paper folded or wrinkled?</p>	Go to step 2.	The problem is solved.
<p>Step 2</p> <p>a. Load paper from a fresh package.</p> <p>Paper absorbs moisture due to high humidity. Store paper in its original wrapper until you are ready to use it.</p> <p>b. Print the document.</p> <p>Is the paper folded or wrinkled?</p>	Go to step 3.	The problem is solved.
<p>Step 3</p> <p>a. Depending on your operating system, specify the paper type from the Printing Preferences or Print dialog.</p> <ul style="list-style-type: none"> • Make sure that the setting matches the paper loaded. • You can also change the setting from the printer control panel. Navigate to Settings > Paper > Tray Configuration > Paper Size/Type. <p>b. Print the document.</p> <p>Is the paper folded or wrinkled?</p>	Refer to Contacting Customer Support .	The problem is solved.

Gray Background

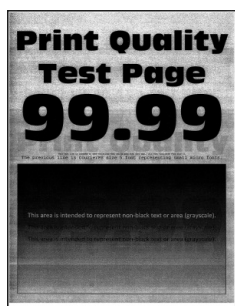

 **Note:** Before solving the problem, print the Print Quality Test Pages. From the control panel, navigate to **Settings > Troubleshooting > Print Quality Test Pages**. For non-touch-screen printer models, press **OK** to navigate through the settings.

Action	Yes	No
<p>Step 1</p> <p>a. Turn off the printer, wait for 10 seconds, and then turn on the printer.</p> <p>b. Decrease toner darkness.</p> <p>From the control panel, navigate to: Settings > Print > Quality > Toner Darkness</p> <p>c. Print the document.</p> <p>Does gray background appear on prints?</p>	Go to step 2.	The problem is solved.
<p>Step 2</p> <p>a. Check if the printer is using a genuine and supported Xerox toner cartridge.</p> <p>If the toner cartridge is not supported, then install a supported one.</p> <p>b. Print the document.</p> <p>Does gray background appear on prints?</p>	Go to step 3.	The problem is solved.
<p>Step 3</p> <p>a. Depending on your operating system, specify the paper type from the Printing Preferences or Print dialog.</p> <ul style="list-style-type: none"> Make sure that the setting matches the paper loaded. 	Go to step 4.	The problem is solved.

Action	Yes	No
<ul style="list-style-type: none"> You can also change the setting from the printer control panel. Navigate to Settings > Paper > Tray Configuration > Paper Size/Type. <p>b. Print the document.</p> <p>Does gray background appear on prints?</p>		
<p>Step 4</p> <p>a. Remove, and then insert the imaging unit.</p> <p>Do not expose the imaging unit to direct light for more than 10 minutes. Extended exposure to light may cause print quality problems.</p> <p>Do not touch the photoconductor drum under the imaging unit. Doing so may affect the quality of future print jobs.</p> <p>b. Print the document.</p> <p>Does gray background appear on prints?</p>	Go to step 5.	The problem is solved.
<p>Step 5</p> <p>a. Update the printer firmware. For more information, see Updating Firmware.</p> <p>b. Print the document.</p> <p>Does gray background appear on prints?</p>	Go to step 6.	The problem is solved.
<p>Step 6</p> <p>a. Replace the imaging unit.</p> <p>b. Print the document.</p> <p>Does gray background appear on prints?</p>	Refer to Contacting Customer Support .	The problem is solved.

Incorrect margins



Action	Yes	No
<p>Step 1</p> <p>a. Adjust the paper guides to the correct position for the paper loaded.</p> <p>b. Print the document.</p> <p>Are the margins correct?</p>	The problem is solved.	Go to step 2.
<p>Step 2</p> <p>a. Set the paper size.</p> <p>From the control panel, navigate to: Settings > Paper > Tray Configuration > Paper Size/Type</p> <p>b. Print the document.</p> <p>Are the margins correct?</p>	The problem is solved.	Go to step 3.
<p>Step 3</p> <p>a. Depending on your operating system, specify the paper size from the Printing Preferences or Print dialog.</p> <p>Make sure that the setting matches the paper loaded.</p> <p>b. Print the document.</p> <p>Are the margins correct?</p>	The problem is solved.	Refer to Contacting Customer Support .

Light print

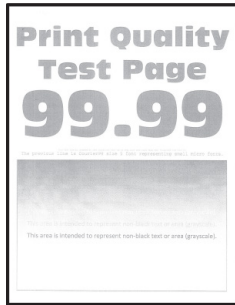

Note: Before solving the problem, print the Print Quality Test Pages. From the control panel, navigate to **Settings > Troubleshooting > Print Quality Test Pages**. For non-touch-screen printer models, press **OK** to navigate through the settings.

Action	Yes	No
<p>Step 1</p> <p>a. Check if the printer is using a genuine and supported Xerox toner cartridge.</p> <p>If the cartridge is not supported, then install a supported one.</p> <p>b. Print the document.</p> <p>Is the print light?</p>	Go to step 2.	The problem is solved.
<p>Step 2</p> <p>a. Turn off the printer, wait for about 10 seconds, and then turn on the printer.</p> <p>b. Increase toner darkness.</p> <p>From the control panel, navigate to: Settings > Print > Quality > Toner Darkness</p> <p>c. Print the document.</p> <p>Is the print light?</p>	Go to step 3.	The problem is solved.
<p>Step 3</p> <p>a. Depending on your operating system, specify the paper type from the Printing Preferences or Print dialog.</p> <ul style="list-style-type: none"> Make sure that the setting matches the paper loaded. 	Go to step 4.	The problem is solved.

Troubleshoot a problem

Action	Yes	No
<ul style="list-style-type: none"> You can also change the setting on the printer control panel. Navigate to Settings > Paper > Tray Configuration > Paper Size/Type. <p>b. Print the document.</p> <p>Is the print light?</p>		
<p>Step 4</p> <p>a. Depending on your operating system, specify the print resolution from the Printing Preferences or Print dialog.</p> <p>b. Set the resolution to 600 dpi.</p> <p>c. Print the document.</p> <p>Is the print light?</p>	Go to step 5.	The problem is solved.
<p>Step 5</p> <p>a. Remove the imaging unit.</p> <p>Do not expose the imaging unit to direct light for more than 10 minutes. Extended exposure to light can cause print quality problems.</p> <p>Do not touch the photoconductor drum under the imaging unit. Doing so may affect the quality of future print jobs.</p> <p>b. Firmly shake the imaging unit to redistribute the toner.</p> <p>c. Insert the imaging unit.</p> <p>d. Turn off the printer, wait for 10 seconds, and then turn on the printer.</p> <p>e. Print the document.</p> <p>Is the print light?</p>	Go to step 6.	The problem is solved.

Action	Yes	No
<p>Step 6</p> <p>a. Check the status of the toner cartridge.</p> <p>From the control panel, navigate to: Settings > Reports > Device > Device Statistics</p> <p>b. From the Supply Information section of the pages printed, check the status of the toner cartridge.</p> <p>Is the toner cartridge near end of life?</p>	<p>Go to step 7.</p>	<p>Refer to Contacting Customer Support.</p>
<p>Step 7</p> <p>a. Replace the toner cartridge.</p> <p>b. Print the document.</p> <p>Is the print light?</p>	<p>Refer to Contacting Customer Support.</p>	<p>The problem is solved.</p>

Mottled print and dots

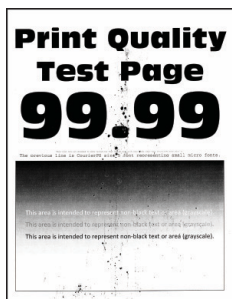

 **Note:** Before solving the problem, print the Print Quality Test Pages. From the control panel, navigate to **Settings > Troubleshooting > Print Quality Test Pages**. For non-touch-screen printer models, press **OK** to navigate through the settings.

Troubleshoot a problem

Action	Yes	No
<p>Step 1</p> <p>a. Check if the printer is using a genuine and supported Xerox toner cartridge.</p> <p>If the cartridge is not supported, then install a supported one.</p> <p>b. Print the document.</p> <p>Is the print mottled?</p>	Go to step 2.	The problem is solved.
<p>Step 2</p> <p>Check the printer for leaked toner contamination.</p> <p>Is the printer free of leaked toner?</p>	Go to step 3.	Refer to Contacting Customer Support .
<p>Step 3</p> <p>a. Check the status of the imaging unit.</p> <p>From the control panel, navigate to: Settings > Reports > Device > Device Statistics</p> <p>b. From the Supply Information section of the pages printed, check the status of the imaging unit.</p> <p>Is the imaging unit near end of life?</p>	Go to step 4.	Contact Contacting Customer Support .
<p>Step 4</p> <p>a. Replace the imaging unit.</p> <p>b. Print the document.</p> <p>Is the print mottled?</p>	Contact Contacting Customer Support .	The problem is solved.

Paper curl



Action	Yes	No
<p>Step 1</p> <p>a. Check if the paper loaded is supported.</p> <p>If paper is not supported, then load a supported paper.</p> <p>b. Print the document.</p> <p>Is the paper curled?</p>	Go to step 2.	The problem is solved.
<p>Step 2</p> <p>a. Check if the printer is using a genuine and supported Xerox toner cartridge.</p> <p>If the cartridge is not supported, then install a supported one.</p> <p>b. Print the document.</p> <p>Is the paper curled?</p>	Go to step 3.	The problem is solved.
<p>Step 3</p> <p>a. Adjust the guides in the tray to the correct position for the paper loaded.</p> <p>b. Print the document.</p> <p>Is the paper curled?</p>	Go to step 4.	The problem is solved.
<p>Step 4</p> <p>a. Depending on your operating system, specify the paper size and paper type from the Printing Preferences or Print dialog.</p>	Go to step 5.	The problem is solved.

Troubleshoot a problem

Action	Yes	No
<ul style="list-style-type: none"> Make sure that the settings match the paper loaded. You can also change the setting on the printer control panel. Navigate to Settings > Paper > Tray Configuration > Paper Size/Type. For non-touch-screen printer models, press OK to navigate through the settings. <p>b. Print the document.</p> <p>Is the paper curled?</p>		
<p>Step 5</p> <p>a. Remove paper, flip it over, and then reload paper.</p> <p>b. Print the document.</p> <p>Is the paper curled?</p>	Go to step 6.	The problem is solved.
<p>Step 6</p> <p>a. Load paper from a fresh package.</p> <p>Paper absorbs moisture due to high humidity. Store paper in its original wrapper until you are ready to use it.</p> <p>b. Print the document.</p> <p>Is the paper curled?</p>	Refer to Contacting Customer Support .	The problem is solved.

Print crooked or skewed



Note: Before solving the problem, print the Print Quality Test Pages. From the control panel, navigate to **Settings > Troubleshooting > Print Quality Test Pages**. For non-touch-screen printer models, press **OK** to navigate through the settings.

Action	Yes	No
<p>Step 1</p> <p>a. Adjust the guides in the tray to the correct position for the paper loaded.</p> <p>b. Print the document.</p> <p>Is the print crooked or skewed?</p>	Go to step 2.	The problem is solved.
<p>Step 2</p> <p>a. Load paper from a fresh package.</p> <p>Paper absorbs moisture due to high humidity. Store paper in its original wrapper until you are ready to use it.</p> <p>b. Print the document.</p> <p>Is the print crooked or skewed?</p>	Go to step 3.	The problem is solved.
<p>Step 3</p> <p>a. Check if the paper loaded is supported.</p> <p>If paper is not supported, then load a supported paper.</p> <p>b. Print the document.</p> <p>Is the print crooked or skewed?</p>	Refer to Contacting Customer Support .	The problem is solved.
<p>Step 4</p> <p>a. For two-sided printing, check if the paper size setting in the duplex unit is set correctly.</p> <p>Letter, legal, Oficio, or folio must be set to Letter.</p> <p>b. Print the document.</p> <p>Is the print crooked or skewed?</p>	Refer to Contacting Customer Support .	The problem is solved.

Solid black pages





 **Note:** Before solving the problem, print the Print Quality Test Pages. From the control panel, navigate to **Settings > Troubleshooting > Print Quality Test Pages**. For non-touch-screen printer models, press **OK** to navigate through the settings.

Action	Yes	No
<p>Step 1</p> <p>a. Check if the printer is using a genuine and supported Xerox toner cartridge.</p> <p>If the toner cartridge is not supported, then install a supported one.</p> <p>b. Print the document.</p> <p>Is the printer printing solid black pages?</p>	<p>Go to step 2.</p>	<p>The problem is solved.</p>
<p>Step 2</p> <p>a. Remove, and then insert the imaging unit.</p> <p>Do not expose the imaging unit to direct light for more than 10 minutes. Extended exposure to light may cause print quality problems.</p> <p>Do not touch the photoconductor drum under the imaging unit. Doing so may affect the quality of future print jobs.</p> <p>b. Print the document.</p> <p>Is the printer printing solid black pages?</p>	<p>Go to step 3.</p>	<p>The problem is solved.</p>

Action	Yes	No
<p>Step 3</p> <p>Check the imaging unit for signs of damage.</p> <p>Make sure that the photoconductor drum contact is not bent or out of place.</p> <p>Is the imaging unit free from damage?</p>	<p>Refer to Contacting Customer Support.</p>	<p>Go to step 4.</p>
<p>Step 4</p> <p>a. Replace the imaging unit. b. Print the document.</p> <p>Is the printer printing solid black pages?</p>	<p>Contact Contacting Customer Support.</p>	<p>The problem is solved.</p>

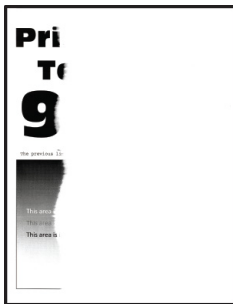
Text or images cut off



 **Note:** Before solving the problem, print the Print Quality Test Pages. From the control panel, navigate to **Settings > Troubleshooting > Print Quality Test Pages**. For non-touch-screen printer models, press **OK** to navigate through the settings.

Troubleshoot a problem

Action	Yes	No
<p>Step 1</p> <p>a. Check if the printer is using a genuine and supported Xerox toner cartridge.</p> <p>If the toner cartridge is not supported, then install a supported one.</p> <p>b. Print the document.</p> <p>Are text or images cut off?</p>	Go to step 2.	The problem is solved.
<p>Step 2</p> <p>a. Remove, and then insert the imaging unit.</p> <p>Do not expose the imaging unit to direct light for more than 10 minutes. Extended exposure to light may cause print quality problems.</p> <p>Do not touch the photoconductor drum under the imaging unit. Doing so may affect the quality of future print jobs.</p> <p>b. Print the document.</p> <p>Are text or images cut off?</p>	Go to step 3.	The problem is solved.
<p>Step 3</p> <p>a. Replace the imaging unit.</p> <p>b. Print the document.</p> <p>Are text or images cut off?</p>	Refer to Contacting Customer Support .	The problem is solved.

Toner easily rubs off



 **Note:** Before solving the problem, print the Print Quality Test Pages. From the control panel, navigate to **Settings > Troubleshooting > Print Quality Test Pages**. For non-touch-screen printer models, press **OK** to navigate through the settings.

Action	Yes	No
<p>Step 1</p> <p>a. Check if the printer is using a genuine and supported Xerox toner cartridge.</p> <p>If the toner cartridge is not supported, then install a supported one.</p> <p>b. Print the document.</p> <p>Does toner easily rub off?</p>	<p>Go to step 2.</p>	<p>The problem is solved.</p>
<p>Step 2</p> <p>a. Depending on your operating system, specify the paper type from the Printing Preferences or Print dialog.</p> <ul style="list-style-type: none"> Make sure that the setting matches the paper loaded. You can also change the setting on the printer control panel. Navigate to Settings > Paper > Tray Configuration > Paper Size/Type. <p>b. Print the document.</p> <p>Does toner easily rub off?</p>	<p>Refer to Contacting Customer Support.</p>	<p>The problem is solved.</p>

Horizontal light bands



 **Note:** Before solving the problem, print the Print Quality Test Pages. From the control panel, navigate to **Settings > Troubleshooting > Print Quality Test Pages**. For non-touch-screen printer models, press **OK** to navigate through the settings.

Action	Yes	No
<p>Step 1</p> <p>a. Check if the printer is using a genuine and supported Xerox toner cartridge.</p> <p>If the cartridge is not supported, then install a supported one.</p> <p>b. Print the document.</p> <p>Do horizontal light bands appear on prints?</p>	Go to step 2.	The problem is solved.
<p>Step 2</p> <p>a. Remove, and then insert the imaging unit.</p> <p>Do not expose the imaging unit to direct light for more than 10 minutes. Extended exposure to light may cause print quality problems.</p> <p>Do not touch the photoconductor drum under the imaging unit. Doing so may affect the quality of future print jobs.</p> <p>b. Print the document.</p> <p>Do horizontal light bands appear on prints?</p>	Go to step 3.	The problem is solved.
<p>Step 3</p> <p>a. Replace the imaging unit.</p> <p>b. Print the document.</p> <p>Do horizontal light bands appear on prints?</p>	Refer to Contacting Customer Support .	The problem is solved.

Vertical light bands



 **Note:** Before solving the problem, print the Print Quality Test Pages. From the control panel, navigate to **Settings > Troubleshooting > Print Quality Test Pages**. For non-touch-screen printer models, press **OK** to navigate through the settings.

Action	Yes	No
<p>Step 1</p> <p>a. Check if the printer is using a genuine and supported Xerox toner cartridge.</p> <p>If the cartridge is not supported, then install a supported one.</p> <p>b. Print the document.</p> <p>Do vertical light bands appear on prints?</p>	Go to step 2.	The problem is solved.
<p>Step 2</p> <p>a. Check the status of the toner cartridge.</p> <p>From the control panel, navigate to: Settings > Reports > Device > Device Statistics</p> <p>b. From the Supply Information section of the pages printed, check the status of the toner cartridge.</p> <p>Do vertical light bands appear on prints?</p>	Go to step 3.	The problem is solved.
<p>Step 3</p> <p>a. Replace the toner cartridge.</p> <p>b. Print the document.</p> <p>Do vertical light bands appear on prints?</p>	Refer to Contacting Customer Support .	The problem is solved.

Vertical white lines



Note: Before solving the problem, print the Print Quality Test Pages. From the control panel, navigate to **Settings > Troubleshooting > Print Quality Test Pages**. For non-touch-screen printer models, press **OK** to navigate through the settings.

Action	Yes	No
<p>Step 1</p> <p>a. Check if the printer is using a genuine and supported Xerox toner cartridge.</p> <p>If the cartridge is not supported, then install a supported one.</p> <p>b. Print the document.</p> <p>Do vertical white lines appear on prints?</p>	<p>Go to step 2.</p>	<p>The problem is solved.</p>
<p>Step 2</p> <p>a. Depending on your operating system, specify the paper type from the Printing Preferences or Print dialog.</p> <ul style="list-style-type: none"> • Make sure that the setting matches the paper loaded. • You can also change the setting on the printer control panel. Navigate to Settings > Paper > Tray Configuration > Paper Size/Type. <p>b. Print the document.</p> <p>Do vertical white lines appear on prints?</p>	<p>Refer to Contacting Customer Support.</p>	<p>The problem is solved.</p>

Vertical dark bands

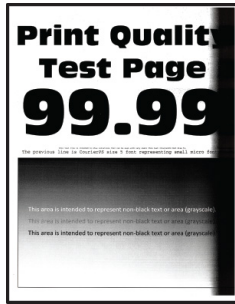

 **Note:** Before solving the problem, print the Print Quality Test Pages. From the control panel, navigate to **Settings > Troubleshooting > Print Quality Test Pages**. For non-touch-screen printer models, press **OK** to navigate through the settings.

Troubleshoot a problem

Action	Yes	No
<p>Step 1</p> <p>a. Check if the printer is using a genuine and supported Xerox toner cartridge.</p> <p>If the toner cartridge is not supported, then install a supported one.</p> <p>b. Print the document.</p> <p>Do vertical dark bands appear on prints?</p>	Go to step 2.	The problem is solved.
<p>Step 2</p> <p>a. Remove, and then insert the imaging unit.</p> <p>Do not expose the imaging unit to direct light for more than 10 minutes. Extended exposure to light may cause print quality problems.</p> <p>Do not touch the photoconductor drum under the imaging unit. Doing so may affect the quality of future print jobs.</p> <p>b. Print the document.</p> <p>Do vertical dark bands appear on prints?</p>	Go to step 3.	The problem is solved.
<p>Step 3</p> <p>a. Check if a bright light enters the right side of the printer, and move the printer if necessary.</p> <p>b. Print the document.</p> <p>Do vertical dark bands appear on prints?</p>	Refer to Contacting Customer Support .	The problem is solved.

Vertical dark lines or streaks

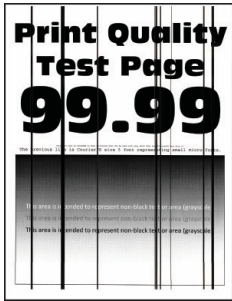



Note: Before solving the problem, print the Print Quality Test Pages. From the control panel, navigate to **Settings > Troubleshooting > Print Quality Test Pages**. For non-touch-screen printer models, press **OK** to navigate through the settings.

Troubleshoot a problem

Action	Yes	No
<p>Step 1</p> <p>a. Check if the printer is using a genuine and supported Xerox toner cartridge.</p> <p>If the toner cartridge is not supported, then install a supported one.</p> <p>b. Print the document.</p> <p>Do vertical dark lines or streaks appear on prints?</p>	Go to step 2.	The problem is solved.
<p>Step 2</p> <p>a. Remove, and then reinstall the imaging unit.</p> <p>Do not expose the imaging unit to direct light for more than 10 minutes. Extended exposure to light can cause print quality problems.</p> <p>Do not touch the photoconductor drum under the imaging unit. Doing so may affect the quality of future print jobs.</p> <p>b. Print the document.</p> <p>Do vertical dark lines or streaks appear on prints?</p>	Go to step 3.	The problem is solved.
<p>Step 3</p> <p>a. Replace the imaging unit.</p> <p>b. Print the document.</p> <p>Do vertical dark lines or streaks appear on prints?</p>	Refer to Contacting Customer Support .	The problem is solved.

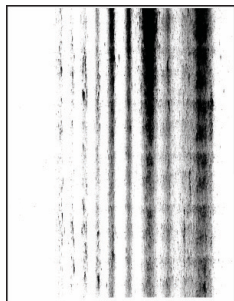
Vertical dark streaks with print missing



 **Note:** Before solving the problem, print the Print Quality Test Pages. From the control panel, navigate to **Settings > Troubleshooting > Print Quality Test Pages**. For non-touch-screen printer models, press **OK** to navigate through the settings.

Action	Yes	No
<p>Step 1</p> <p>a. Remove, and then insert the imaging unit.</p> <p>Do not expose the imaging unit to direct light for more than 10 minutes. Extended exposure to light may cause print quality problems.</p> <p>Do not touch the photoconductor drum under the imaging unit. Doing so may affect the quality of future print jobs.</p> <p>b. Print the document.</p> <p>Do vertical dark streaks with missing images appear on prints?</p>	<p>Go to step 2.</p>	<p>The problem is solved.</p>
<p>Step 2</p> <p>a. Check if the printer is using a genuine and supported Xerox toner cartridge.</p> <p>If the toner cartridge is not supported, then install a supported one.</p> <p>b. Print the document.</p> <p>Do vertical dark streaks with missing images appear on prints?</p>	<p>Refer to Contacting Customer Support.</p>	<p>The problem is solved.</p>

Repeating defects



Note: Before solving the problem, print the Print Quality Test Pages. From the control panel, navigate to **Settings > Troubleshooting > Print Quality Test Pages**. For non-touch-screen printer models, press **OK** to navigate through the settings.

Action	Yes	No
<p>Step 1</p> <p>Using the Print Quality Test Pages, check if the distance between the repeating defects is equal to any of the following:</p> <ul style="list-style-type: none"> • Imaging unit <ul style="list-style-type: none"> – 75.40 mm (2.97 in.) – 34.70 mm (1.37 in.) – 23.9 mm (0.94 in.) • Toner cartridge <ul style="list-style-type: none"> – 35.70 mm (1.41 in.) – 36.80 mm (1.45 in.) • Transfer roller <ul style="list-style-type: none"> – 44 mm (1.73 in.) • Fuser <ul style="list-style-type: none"> – 78.1 mm (3.07 in.) – 75.4 mm (2.97 in.) <p>Does the distance between the repeating defects match any of the measurements?</p>	<p>Go to step 2.</p>	<p>Take note of the distance, and then refer to Contacting Customer Support.</p>
<p>Step 2</p> <p>a. Replace the supply item that matches the repeating defects distance.</p> <p>If the supply item is a transfer roller or fuser, then refer to Contacting Customer Support.</p> <p>b. Print the document.</p> <p>Do the repeating defects appear?</p>	<p>Refer to Contacting Customer Support.</p>	<p>The problem is solved.</p>

Print jobs do not print

Action	Yes	No
<p>Step 1</p> <ol style="list-style-type: none"> 1 From the document you are trying to print, open the Print dialog, and then check if you have selected the correct printer. 2 Print the document. <p>Is the document printed?</p>	The problem is solved.	Go to step 2.
<p>Step 2</p> <ol style="list-style-type: none"> 1 Check if the printer is on. 2 Resolve any error messages that appear on the display. 3 Print the document. <p>Is the document printed?</p>	The problem is solved.	Go to step 3.
<p>Step 3</p> <ol style="list-style-type: none"> 1 Check if the ports are working and if the cables are securely connected to the computer and the printer. <p>For more information, see the setup documentation that came with the printer.</p> <ol style="list-style-type: none"> 2 Print the document. <p>Is the document printed?</p>	The problem is solved.	Go to step 4.
<p>Step 4</p> <ol style="list-style-type: none"> 1 Turn off the printer, wait for about 10 seconds, and then turn on the printer. 2 Print the document. <p>Is the document printed?</p>	The problem is solved.	Go to step 5.
<p>Step 5</p> <ol style="list-style-type: none"> 1 Remove, and then reinstall the print driver. 2 Print the document. <p>Is the document printed?</p>	The problem is solved.	Refer to Contacting Customer Support .

Job prints from the wrong tray or on the wrong paper

Action	Yes	No
<p>Step 1</p> <p>a. Check if you are printing on the correct paper. b. Print the document.</p> <p>Is the document printed on the correct paper?</p>	Go to step 2.	Load the correct paper size and paper type.
<p>Step 2</p> <p>a. Depending on your operating system, specify the paper size and paper type from the Printing Preferences or Print dialog.</p> <p>You can also change the settings on the printer control panel. Navigate to:</p> <p>Settings > Paper > Tray Configuration > Paper Size/Type</p> <p>For non-touch-screen printer models, press OK to navigate through the settings.</p> <p>b. Make sure that the settings match the paper loaded. c. Print the document.</p> <p>Is the document printed on the correct paper?</p>	The problem is solved.	Refer to Contacting Customer Support .

Slow printing

Action	Yes	No
<p>Step 1</p> <p>Make sure that the printer cable is securely connected to the printer and to the computer, print server, or other network device.</p> <p>Is the printer printing slow?</p>	Go to step 2.	The problem is solved.
<p>Step 2</p>	Go to step 3.	The problem is solved.

Troubleshoot a problem

Action	Yes	No
<p>a. Make sure that the printer is not in Quiet Mode.</p> <p>From the control panel, navigate to: Settings > Device > Maintenance > Config Menu > Device Operations > Quiet Mode</p> <p>For non-touch-screen printer models, press OK to navigate through the settings.</p> <p>b. Print the document.</p> <p>Is the printer printing slow?</p>		
<p>Step 3</p> <p>a. Depending on your operating system, specify the print resolution from the Printing Preferences or Print dialog.</p> <p>b. Set the resolution to 600 dpi.</p> <p>c. Print the document.</p> <p>Is the printer printing slow?</p>	Go to step 4.	The problem is solved.
<p>Step 4</p> <p>a. From the control panel, navigate to: Settings > Print > Quality > Print Resolution</p> <p>For non-touch-screen printer models, press OK to navigate through the settings.</p> <p>b. Set the resolution to 600 dpi.</p> <p>c. Print the document.</p> <p>Is the printer printing slow?</p>	Go to step 5.	The problem is solved.
<p>Step 5</p> <p>a. Depending on your operating system, specify the paper type setting from the Printing Preferences or Print dialog.</p> <ul style="list-style-type: none"> • Make sure that the setting matches the paper loaded. • You can also change the setting on the printer control panel. Navigate to Settings > Paper > Tray 	Go to step 6.	The problem is solved.

Action	Yes	No
<p>Configuration > Paper Size/Type. For non-touch-screen printer models, press OK to navigate through the settings.</p> <ul style="list-style-type: none"> • Heavier paper prints more slowly. • Paper narrower than letter, A4, and legal may print more slowly. <p>b. Print the document.</p> <p>Is the printer printing slow?</p>		
<p>Step 6</p> <p>a. Make sure that the printer settings for texture and weight match the paper being loaded.</p> <p>From the control panel, navigate to: Settings > Paper > Media Configuration > Media Types</p> <p>For non-touch-screen printer models, press OK to navigate through the settings.</p> <p>Rough paper textures and heavy paper weights may print more slowly.</p> <p>b. Print the document.</p> <p>Is the printer printing slow?</p>	<p>Go to step 7.</p>	<p>The problem is solved.</p>

Troubleshoot a problem

Action	Yes	No
<p>Step 7</p> <p>Remove held jobs.</p> <p>Is the printer printing slow?</p>	Go to step 8.	The problem is solved.
<p>Step 8</p> <p>a. Make sure that the printer is not overheating.</p> <ul style="list-style-type: none"> • Allow the printer to cool down after a long print job. • Observe the recommended ambient temperature for the printer. For more information, see Selecting a location for the printer. <p>b. Print the document.</p> <p>Is the printer printing slow?</p>	Refer to Contacting Customer Support.	The problem is solved.

The printer is not responding

Action	Yes	No
<p>Step 1</p> <p>Check if the power cord is connected to the electrical outlet.</p> <p>To avoid the risk of fire or electrical shock, connect the power cord to an appropriately rated and properly grounded electrical outlet that is near the product and easily accessible.</p> <p>Is the printer responding?</p>	<p>The problem is solved.</p>	<p>Go to step 2.</p>
<p>Step 2</p> <p>Check if the electrical outlet is turned off by a switch or breaker.</p> <p>Is the electrical outlet turned off by a switch or breaker?</p>	<p>Turn on the switch or reset the breaker.</p>	<p>Go to step 3.</p>
<p>Step 3</p> <p>Check if the printer is on.</p> <p>Is the printer on?</p>	<p>Go to step 4.</p>	<p>Turn on the printer.</p>
<p>Step 4</p> <p>Check if the printer is in Sleep or Hibernate mode.</p> <p>Is the printer in Sleep or Hibernate mode?</p>	<p>Press the power button to wake the printer.</p>	<p>Go to step 5.</p>
<p>Step 5</p> <p>Check if the cables connecting the printer and the computer are inserted to the correct ports.</p> <p>Are the cables inserted to the correct ports?</p>	<p>Go to step 6.</p>	<p>Insert the cables to the correct ports.</p>

Troubleshoot a problem

Action	Yes	No
Step 6 Install the correct print driver. Is the printer responding?	The problem is solved.	Go to step 7.
Step 7 Turn off the printer, wait for about 10 seconds, and then turn on the printer. Is the printer responding?	The problem is solved.	Refer to Contacting Customer Support .

Unable to read flash drive

Action	Yes	No
<p>Step 1</p> <p>Check if the printer is not busy processing another print, copy, scan, or fax job.</p> <p>Is the printer ready?</p>	Go to step 2.	Wait for the printer to finish processing the other job.
<p>Step 2</p> <p>Check if the flash drive is supported. For more information, see Supported flash drives and file types.</p> <p>Is the flash drive supported?</p>	Go to step 3.	Insert a supported flash drive.
<p>Step 3</p> <p>Remove, and then insert the flash drive.</p> <p>Does the printer recognize the flash drive?</p>	The problem is solved.	Refer to Contacting Customer Support .

Troubleshoot a problem

Enabling the USB port

From the control panel, navigate to **Settings > Network/Ports > USB > Enable USB Port**

For non-touch-screen printer models, press **OK** to navigate through the settings.

Network connection problems

Cannot open Embedded Web Server

Action	Yes	No
<p>Step 1</p> <p>Check if the printer is on. Is the printer on?</p>	Go to step 2.	Turn on the printer.
<p>Step 2</p> <p>Make sure that the printer IP address is correct.</p> <ul style="list-style-type: none"> • View the IP address on the home screen. • An IP address appears as four sets of numbers separated by periods, such as 123.123.123.123. <p>Is the printer IP address correct?</p>	Go to step 3.	Type the correct printer IP address in the address field.
<p>Step 3</p> <p>Check if you are using a supported browser:</p> <ul style="list-style-type: none"> • Internet Explorer version 11 or later • Microsoft Edge • Safari version 6 or later • Google Chrome™ version 32 or later • Mozilla Firefox version 24 or later <p>Is your browser supported?</p>	Go to step 4.	Install a supported browser.
<p>Step 4</p> <p>Check if the network connection is working. Is the network connection working?</p>	Go to step 5.	Contact your administrator.
<p>Step 5</p> <p>Make sure that the cable connections to the printer and print server are secure. For more</p>	Go to step 6.	Secure the cable connections.

Action	Yes	No
<p>information, see the documentation that came with the printer.</p> <p>Are the cable connections secure?</p>		
<p>Step 6</p> <p>Check if the web proxy servers are disabled.</p> <p>Are the web proxy servers disabled?</p>	Go to step 7.	Contact your administrator.
<p>Step 7</p> <p>Access the Embedded Web Server.</p> <p>Did the Embedded Web Server open?</p>	The problem is solved.	Refer to Contacting Customer Support .

Cannot connect the printer to the Wi-Fi network

Action	Yes	No
<p>Step 1</p> <p>Make sure that Active Adapter is set to Auto.</p> <p>From the control panel, navigate to Settings > Network/Ports > Network Overview > Active Adapter > Auto</p> <p>For non-touch-screen printer models, press OK to navigate through the settings.</p> <p>Can the printer connect to the Wi-Fi network?</p>	The problem is solved.	Go to step 2.
<p>Step 2</p> <p>Check if the correct Wi-Fi network is selected.</p> <p>Some routers may share the default SSID.</p> <p>Are you connecting to the correct Wi-Fi network?</p>	Go to step 4.	Go to step 3.
<p>Step 3</p>	The problem is solved.	Go to step 4.

Action	Yes	No
<p>Connect to the correct Wi-Fi network. For more information, see Connecting the Printer to a Wi-Fi Network.</p> <p>Can the printer connect to the Wi-Fi network?</p>		
<p>Step 4</p> <p>Check the wireless security mode.</p> <p>From the control panel, navigate to Settings > Network/Ports > Wireless > Wireless Security Mode</p> <p>For non-touch-screen printer models, press OK to navigate through the settings.</p> <p>Is the correct wireless security mode selected?</p>	Go to step 6.	Go to step 5.
<p>Step 5</p> <p>Select the correct wireless security mode.</p> <p>Can the printer connect to the Wi-Fi network?</p>	The problem is solved.	Go to step 6.
<p>Step 6</p> <p>Make sure that you entered the correct network password.</p> <p>Take note of the spaces, numbers, and capitalization in the password.</p> <p>Can the printer connect to the Wi-Fi network?</p>	The problem is solved.	Refer to Contacting Customer Support .

Issues with supplies

Replace cartridge, printer region mismatch — Use 708699

To correct this problem, purchase a cartridge with the correct region that matches the printer region, or purchase a worldwide cartridge.

- The first number in the message after 42 indicates the region of the printer.
- The second number in the message after 42 indicates the region of the cartridge.

Table 12.1 Printer and toner cartridge regions

Region	Numeric code
Worldwide or Undefined region	0
North America (United States, Canada)	1
European Economic Area, Western Europe, Nordic countries, Switzerland	2
Asia Pacific	3
Latin America	4
Rest of Europe, Middle East, Africa	5
Australia, New Zealand	6
Invalid region	9



Note: To find the region settings of the printer and toner cartridge, print the print quality test pages. From the control panel, navigate to: **Settings > Troubleshooting > Print Quality Test Pages**.

Non-Xerox Supplies

The printer has detected a non-Xerox supply installed in the printer.

Your Xerox printer is designed to function best with genuine Xerox supplies. Use of third-party supplies can affect the performance, reliability, or life of the printer and its imaging components.

All life indicators are designed to function with Xerox supplies and can deliver unpredictable results if third-party supplies are used. Imaging component usage beyond the intended life may damage your Xerox printer or associated components.

 **Warning:** Use of third-party supplies or parts can affect warranty coverage. Damage caused by the use of third-party supplies or parts may not be covered by the warranty.

To accept any and all of these risks and to proceed with the use of non-genuine supplies in your printer, press and hold X and OK simultaneously for 15 seconds.

If you do not want to accept these risks, then remove the third-party supply or part from your printer and install a genuine Xerox supply or part. For more information, refer to [Using Genuine Xerox Supplies](#).

Clearing Jams

Avoiding Jams

Load Paper Properly

- Make sure that the paper lies flat in the tray.

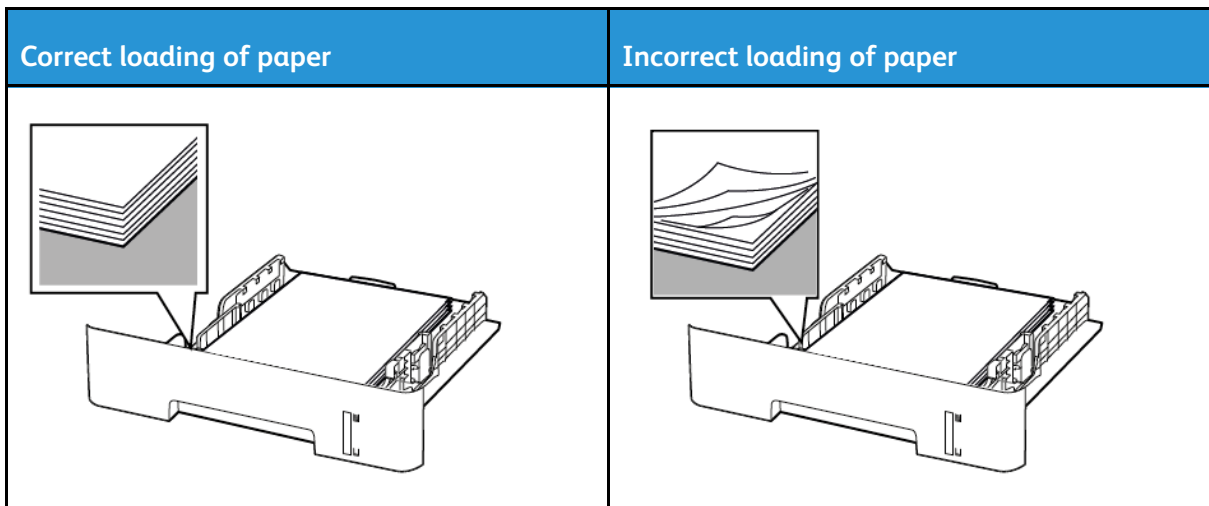

- Do not load or remove a tray while the printer is printing.
- Do not load too much paper. Make sure that the stack height is below the maximum paper fill indicator.
- Do not slide paper into the tray. Load paper as shown in the illustration.

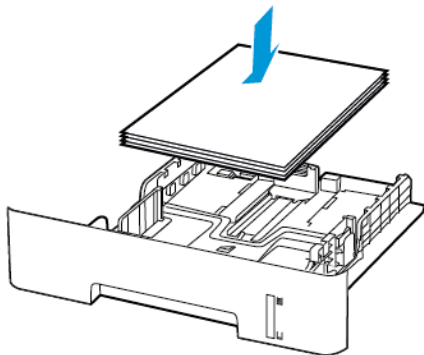

- Make sure that the paper guides are positioned correctly and are not pressing tightly against the paper or envelopes.
- For two-sided printing on A4-size paper, make sure that the paper size setting in the duplex unit is set to A4.
- For two-sided printing on letter-, legal-, Oficio-, or folio-size paper, make sure that the paper size setting in the duplex unit is set to Letter.
- Push the tray firmly into the printer after loading paper.

Use Recommended Paper

- Use only recommended paper or specialty media.
- Do not load paper that is wrinkled, creased, damp, bent, or curled.
- Flex, fan, and align the paper edges before loading.

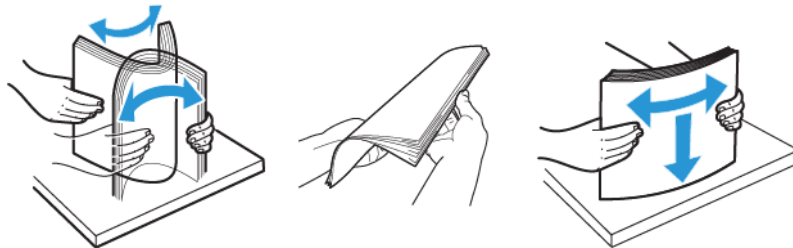

- Do not use paper that has been cut or trimmed by hand.
- Do not mix paper sizes, weights, or types in the same tray.
- Make sure that the paper size and type are set correctly on the computer or printer control panel.
- Store paper according to manufacturer recommendations.

Identifying Jam Locations

- When Jam Assist is set to On, the printer flushes blank pages or pages with partial prints after a jammed page has been cleared. Check your printed output for blank pages.
- When Jam Recovery is set to On or Auto, the printer reprints jammed pages.

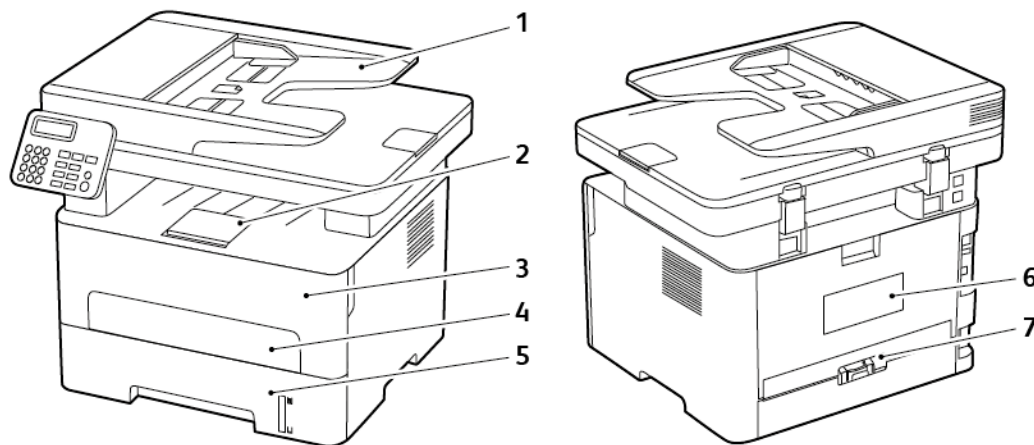

1. Automatic document feeder (ADF)
2. Standard output tray
3. Front door
4. Manual feeder
5. Tray

Troubleshoot a problem

6. Rear door
7. Duplex unit

Paper Jam in the Tray

1. Remove the tray.

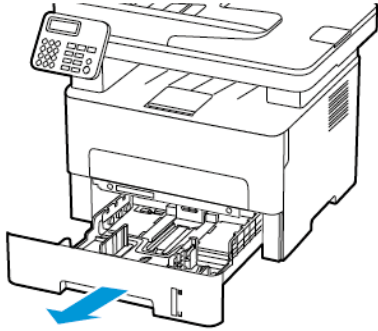

2. Remove the jammed paper.

 **Note:** Make sure that all paper fragments are removed.

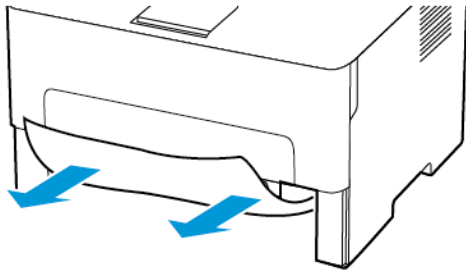

3. Insert the tray.

Paper Jam in the Front Door

1. Open the front door.

 **Warning:** To prevent damage from electrostatic discharge, touch any exposed metal frame of the printer before accessing or touching interior areas of the printer.

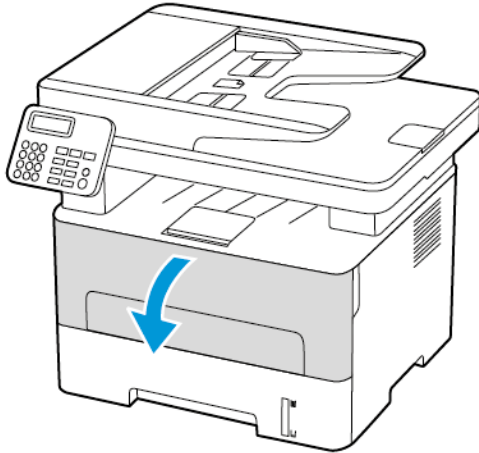

Troubleshoot a problem

2. Remove the imaging unit.

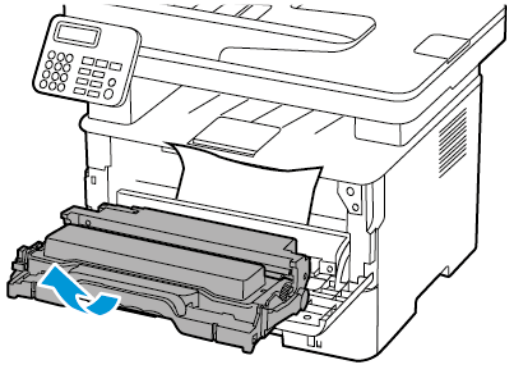

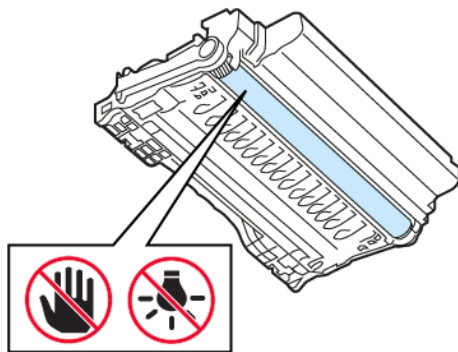

 **Warning:** Do not expose the imaging unit to direct light for more than 10 minutes. Extended exposure to light may cause print quality problems.

 **Warning:** Do not touch the photoconductor drum. Doing so may affect the quality of future print jobs.



3. Remove the jammed paper.

 **CAUTION—HOT SURFACE:** The inside of the printer might be hot. To reduce the risk of injury from a hot component, allow the surface to cool before touching it.

 **Note:** Make sure that all paper fragments are removed.

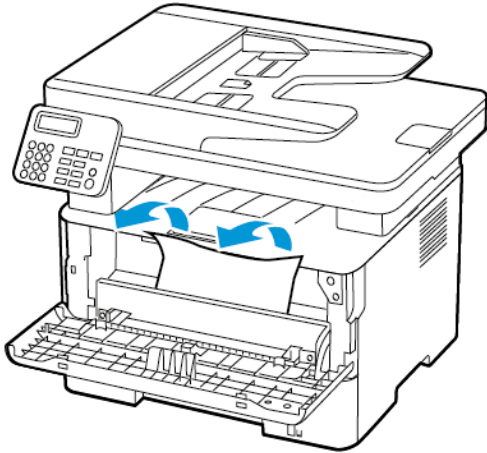

4. Insert the imaging unit.

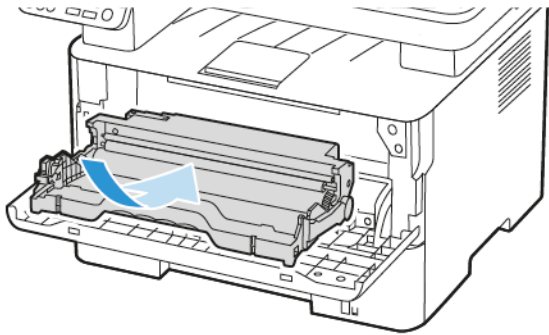

5. Close the door.

Paper Jam in the Rear Door

1. Open the rear door.



CAUTION—HOT SURFACE: The inside of the printer might be hot. To reduce the risk of injury from a hot component, allow the surface to cool before touching it.

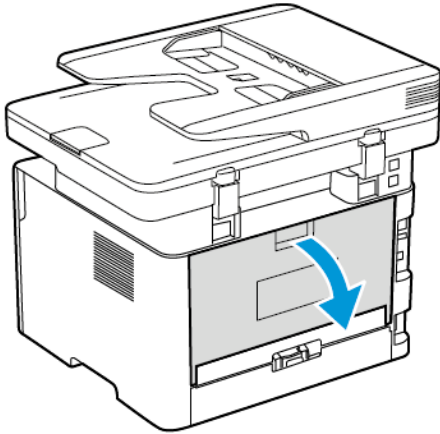

2. Open the fuser access door.

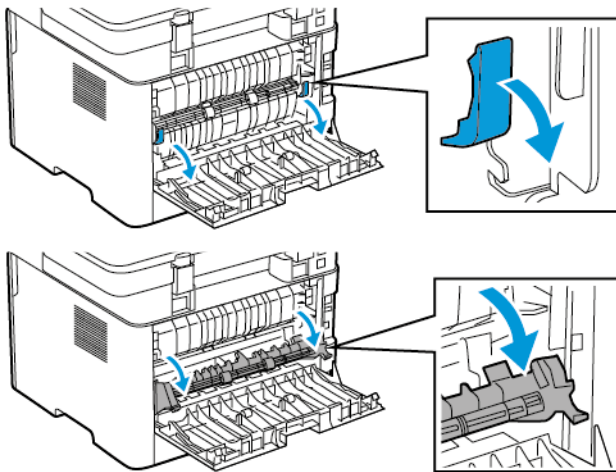

3. Remove the jammed paper.

 **Note:** Make sure that all paper fragments are removed.

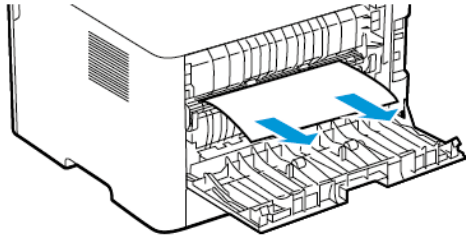



4. Close the fuser access door.
5. Close the rear door.

Paper Jam in the Duplex Unit

1. Pull out the duplex unit, and then remove the jammed paper.

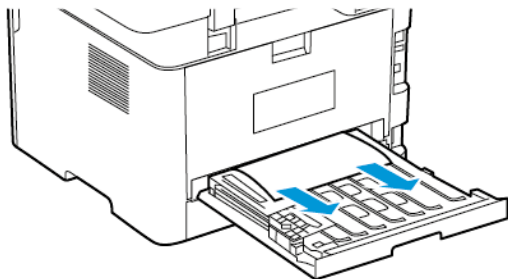
 **Warning:** To prevent damage from electrostatic discharge, touch any exposed metal frame of the printer before accessing or touching interior areas of the printer.



 **Note:** Make sure that all paper fragments are removed.

2. Insert the duplex unit.

Paper Jam in the Standard Output Tray

1. Raise the scanner, and then remove the jammed paper.

 **Note:** Make sure that all paper fragments are removed.

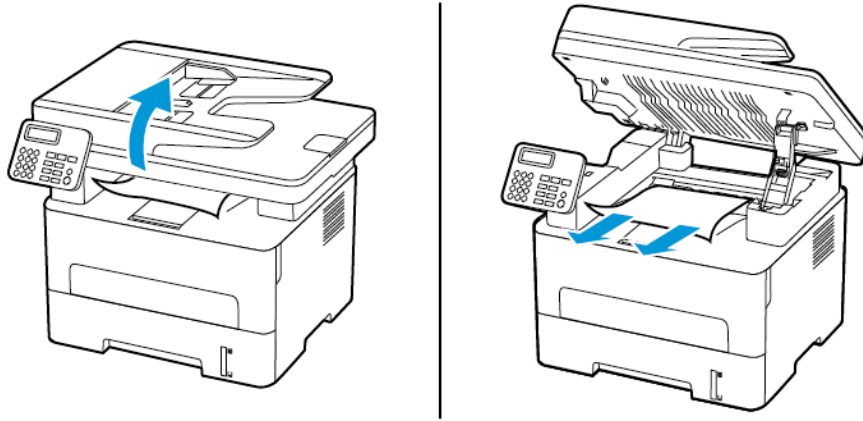

2. Lower the scanner.

Paper Jam in the Manual Feeder

Remove the jammed paper.

 **Note:** Make sure that all paper fragments are removed.

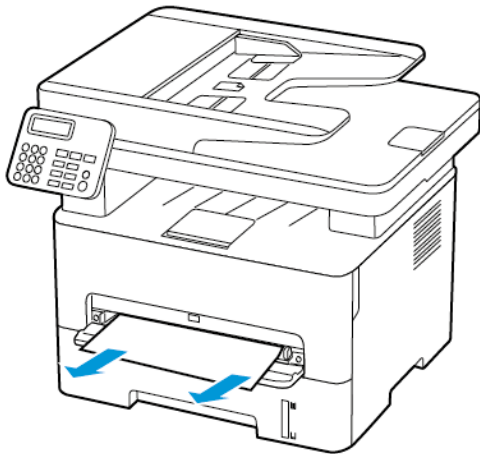

Paper Jam in the Automatic Document Feeder

1. Remove all original documents from the ADF tray.

2. Open the ADF cover.

 **Warning:** To prevent damage from electrostatic discharge, touch any exposed metal frame of the printer before accessing or touching interior areas of the printer.

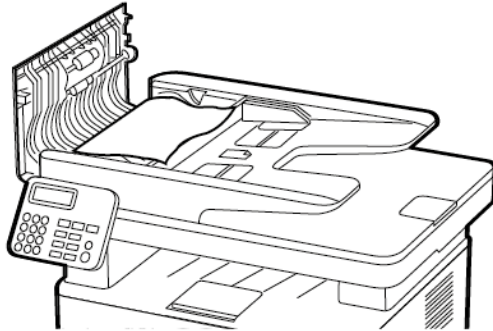

3. Remove the jammed paper.

 **Note:** Ensure that all paper fragments are removed.

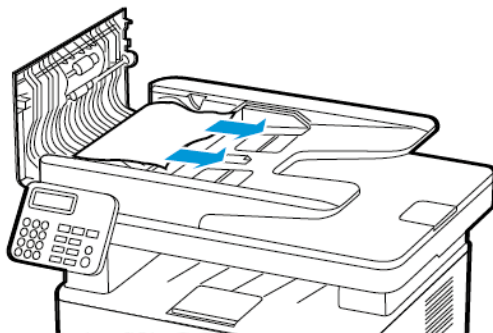

4. Close the ADF cover.
5. Open the scanner cover.

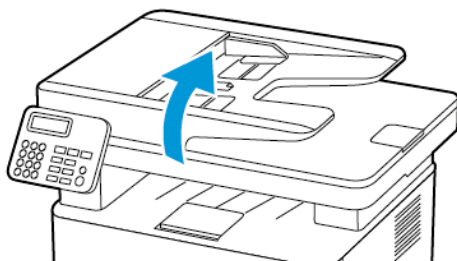

Troubleshoot a problem

6. Remove the jammed paper.

 **Note:** Make sure that all paper fragments are removed.

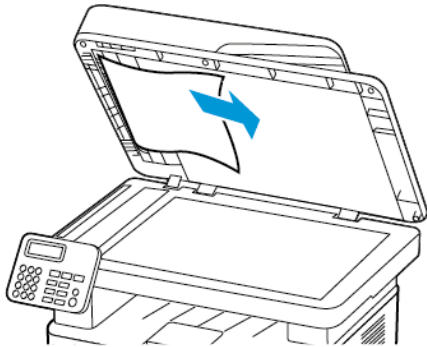

7. Close the scanner cover.

Paper feed problems

Envelope seals when printing

Action	Yes	No
<p>Step 1</p> <p>a. Use an envelope that has been stored in a dry environment.</p> <p>Printing on envelopes with high moisture content can seal the flaps.</p> <p>b. Send the print job.</p> <p>Does the envelope seal when printing?</p>	<p>Go to step 2.</p>	<p>The problem is solved.</p>
<p>Step 2</p> <p>a. Make sure that paper type is set to Envelope.</p> <p>From the control panel, navigate to Settings > Paper > Tray Configuration > Paper Size/Type</p> <p>For non-touch-screen printer models, press OK to navigate through the settings.</p> <p>b. Send the print job.</p> <p>Does the envelope seal when printing?</p>	<p>Refer to Contacting Customer Support.</p>	<p>The problem is solved.</p>

Collated printing does not work

Action	Yes	No
<p>Step 1</p> <p>a. From the control panel, navigate to Settings > Print > Layout > Collate</p> <p>For non-touch-screen printer models, press OK to navigate through the settings.</p> <p>b. Select On [1,2,1,2,1,2].</p> <p>c. Print the document.</p> <p>Is the document collated correctly?</p>	<p>The problem is solved.</p>	<p>Go to step 2.</p>
<p>Step 2</p> <p>a. From the document that you are trying to print, open the Print dialog, and then select Collate.</p> <p>b. Print the document.</p> <p>Is the document collated correctly?</p>	<p>The problem is solved.</p>	<p>Go to step 3.</p>
<p>Step 3</p> <p>a. Reduce the number of pages to print.</p> <p>b. Print the document.</p> <p>Are the pages collated correctly?</p>	<p>The problem is solved.</p>	<p>Refer to Contacting Customer Support.</p>

Paper frequently jams

Action	Yes	No
<p>Step 1</p> <p>a. Remove the tray.</p> <p>b. Check if paper is loaded correctly.</p> <ul style="list-style-type: none"> • Make sure that the paper guides are positioned correctly. • Make sure that the stack height is below the maximum paper fill indicator. • Make sure to print on recommended paper size and type. <p>c. Insert the tray.</p> <p>d. Print the document.</p> <p>Do paper jams occur frequently?</p>	Go to step 2.	The problem is solved.
<p>Step 2</p> <p>a. From the control panel, navigate to Settings > Paper > Tray Configuration > Paper Size/Type</p> <p>For non-touch-screen printer models, press OK to navigate through the settings.</p> <p>b. Set the correct paper size and type.</p> <p>c. Print the document.</p> <p>Do paper jams occur frequently?</p>	Go to step 3.	The problem is solved.
<p>Step 3</p> <p>a. Load paper from a fresh package.</p> <p>Paper absorbs moisture due to high humidity. Store paper in its original wrapper until you are ready to use it.</p> <p>b. Print the document.</p> <p>Do paper jams occur frequently?</p>	Refer to Contacting Customer Support .	The problem is solved.

Jammed pages are not reprinted

Action	Yes	No
<p>a. From the control panel, navigate to Settings > Device > Notifications > Jam Content Recovery</p> <p>For non-touch-screen printer models, press OK to navigate through the settings.</p> <p>b. In the Jam Recovery menu, select On or Auto.</p> <p>c. Print the document.</p> <p>Are the jammed pages reprinted?</p>	<p>The problem is solved.</p>	<p>Contact Contacting Customer Support.</p>

E-mailing problems

Disabling the SMTP server not set up error Message

Depending on your printer model, from the control panel, select an option:

- Touch **Home** > **Settings** > **E-mail** > **E-mail Setup** > **Disable “SMTP Server not set up” error** > **On**.
- Navigate to **Settings** > **E-mail** > **OK** > **E-mail Setup** > **OK** > **Disable “SMTP Server not set up” error** > **OK** > **On** > **OK**.

To prevent the error from happening again, do one of the following:

- Update the firmware. For more information, see
- Configure the e-mail SMTP settings. For more information, see [Updating Firmware.Configuring the Email SMTP Settings](#).

Cannot send e-mails

Action	Yes	No
<p>Step 1</p> <p>Make sure that the e-mail SMTP settings are configured correctly. For more information, see Configuring the Email SMTP Settings.</p> <p>Can you send an e-mail?</p>	The problem is solved.	Go to step 2.
<p>Step 2</p> <p>Make sure that you are using the correct password. Depending on your e-mail service provider, use your account password, app password, or authentication password. For more information, see Configuring the Email SMTP Settings.</p> <p>Can you send an e-mail?</p>	The problem is solved.	Go to step 3.
<p>Step 3</p> <p>Make sure that the printer is connected to a network and that the network is connected to the Internet.</p> <p>Can you send an e-mail?</p>	The problem is solved.	Refer to Contacting Customer Support .

Faxing problems

Cannot send or receive faxes

Action	Yes	No
<p>Step 1</p> <p>Resolve any error messages that appear on the display.</p> <p>Can you send or receive a fax?</p>	The problem is solved.	Go to step 2.
<p>Step 2</p> <p>Make sure that the cable connections for the following equipment are secure:</p> <ul style="list-style-type: none"> • Telephone • Handset • Answering machine <p>Can you send or receive a fax?</p>	The problem is solved.	Go to step 3.
<p>Step 3</p> <p>Check for a dial tone.</p> <ul style="list-style-type: none"> • Call the fax number to check if it is working properly. • If you are using the On Hook Dial feature, then turn up the volume to check if you hear a dial tone. <p>Can you hear a dial tone?</p>	Go to step 5.	Go to step 4.
<p>Step 4</p> <p>Check the telephone wall jack.</p> <ol style="list-style-type: none"> a. Connect the analog telephone directly to the wall jack. b. Listen for a dial tone. c. If you do not hear a dial tone, then use a different telephone cable. d. If you still do not hear a dial tone, then connect the analog telephone to a different wall jack. e. If you hear a dial tone, then connect the printer to that wall jack. 	The problem is solved.	Go to step 5.

Action	Yes	No
Can you send or receive a fax?		
<p>Step 5</p> <p>Check if the printer is connected to an analog phone service or to the correct digital connector.</p> <ul style="list-style-type: none"> • If you are using an Integrated Services for Digital Network (ISDN) telephone service, then connect to an analog telephone port of an ISDN terminal adapter. For more information, contact your ISDN provider. • If you are using DSL, then connect to a DSL filter or router that supports analog use. For more information, contact your DSL provider. • If you are using a private branch exchange (PBX) telephone service, then make sure that you are connecting to an analog connection on the PBX. If none exists, then consider installing an analog telephone line for the fax machine. <p>Can you send or receive a fax?</p>	The problem is solved.	Go to step 6.

Troubleshoot a problem

Action	Yes	No
<p>Step 6</p> <p>Temporarily disconnect other equipment and disable other telephone services.</p> <ol style="list-style-type: none"> Disconnect other equipment (such as answering machines, computers, modems, or telephone line splitters) between the printer and the telephone line. Disable call waiting and voice mail. For more information, contact your telephone company. <p>Can you send or receive a fax?</p>	The problem is solved.	Go to step 7.
<p>Step 7</p> <p>Scan the original document one page at a time.</p> <ol style="list-style-type: none"> Dial the fax number. Scan the document. <p>Can you send or receive a fax?</p>	The problem is solved.	Refer to Contacting Customer Support .

Can receive but not send faxes

Action	Yes	No
<p>Step 1</p> <p>Load the original document properly into the ADF tray or on the scanner glass.</p> <p>Can you send faxes?</p>	The problem is solved.	Go to step 2.
<p>Step 2</p> <p>Set up the shortcut number properly.</p> <ul style="list-style-type: none"> Check if the shortcut number is set for the telephone number that you want to dial. Dial the telephone number manually. <p>Can you send faxes?</p>	The problem is solved.	Refer to Contacting Customer Support .

Can send but not receive faxes

Action	Yes	No
<p>Step 1</p> <p>Make sure that the paper source is not empty.</p> <p>Can you receive faxes?</p>	The problem is solved.	Go to step 2.
<p>Step 2</p> <p>Check the ring count delay settings.</p> <p>From the control panel, navigate to Settings > Fax > Fax Setup > Fax Receive Settings > Rings to Answer</p> <p>For non-touch-screen printer models, press OK to navigate through the settings.</p> <p>Can you receive faxes?</p>	The problem is solved.	Go to step 3.
<p>Step 3</p> <p>If the printer is printing blank pages, then see Blank or White Pages.</p> <p>Can you receive faxes?</p>	The problem is solved.	Refer to Contacting Customer Support .

Poor fax print quality

Action	Yes	No
<p>Step 1</p> <p>Make sure that there are no print quality defects.</p> <p>a. From the control panel, navigate to Settings > Troubleshooting > Print Quality Test Pages</p> <p>For non-touch-screen printer models, press OK to navigate through the settings.</p> <p>b. Correct any print quality defects. For more information, see Print quality is poor.</p> <p>Is the fax print quality satisfactory?</p>	<p>The problem is solved.</p>	<p>Go to step 2.</p>
<p>Step 2</p> <p>Decrease the incoming fax transmission speed.</p> <p>a. From the control panel, navigate to Settings > Fax > Fax Setup > Fax Receive Settings > Admin Controls > Max Speed</p> <p>For non-touch-screen printer models, press OK to navigate through the settings.</p> <p>b. Select a lower transmission speed.</p> <p>Is the fax print quality satisfactory?</p>	<p>The problem is solved.</p>	<p>Refer to Contacting Customer Support.</p>

Scanning problems

Cannot scan to a computer

Action	Yes	No
<p>Step 1</p> <p>Perform a copy job.</p> <p>Is the copy job successful?</p>	Go to step 3.	Go to step 2.
<p>Step 2</p> <p>a. Turn off the printer, wait for about 10 seconds, and then turn it back on.</p> <p>b. Scan the document.</p> <p>Can you scan the document to a computer?</p>	The problem is solved.	Go to step 3.
<p>Step 3</p> <p>Check the printer connectivity.</p> <p>a. Print the Network Setup Page. From the control panel, navigate to Settings > Reports > Network > Network Setup Page</p> <p>b. Check the network status.</p> <p>Is the printer connected to the network?</p>	Go to step 5.	Go to step 4.
<p>Step 4</p> <p>a. Connect the printer to the network.</p> <p>b. Scan the document.</p> <p>Can you scan the document to a computer?</p>	The problem is solved.	Go to step 5.
<p>Step 5</p> <p>a. Make sure that the printer and the computer are connected to the same network.</p> <p>b. Scan the document.</p> <p>Can you scan the document to a computer?</p>	The problem is solved.	Refer to Contacting Customer Support .

Cannot scan to a network folder

Action	Yes	No
<p>Step 1</p> <p>a. Create a network folder shortcut.</p> <p>b. Scan a document using the shortcut. For more information, see Scanning to a network folder.</p> <p>Can you scan a document and save it to a network folder?</p>	The problem is solved.	Go to step 2.
<p>Step 2</p> <p> Note: Make sure that the network folder path and format are correct. For example, //server_hostname/foldername/path, where server_hostname is a fully qualified domain (FQDN) or IP address.</p> <p>Is the network folder path and format correct?</p>	Go to step 3.	Go to step 4.
<p>Step 3</p> <p>Make sure that you have a write access permission to the network folder.</p> <p>Can you scan a document and save it to a network folder?</p>	The problem is solved.	Go to step 4.

Action	Yes	No
<p>Step 4</p> <p>Update the network folder shortcut.</p> <ol style="list-style-type: none"> a. Open a web browser, and then type the printer IP address in the address field. <ul style="list-style-type: none"> • View the printer IP address on the home screen. The IP address appears as four sets of numbers separated by periods, such as 123.123.123.123. • If you are using a proxy server, then temporarily disable it to load the web page correctly. b. Click Shortcuts, and then select a shortcut. <p>If you have multiple shortcut types, then select Network Folder.</p> c. In the Share Path field, type the network folder path. <ul style="list-style-type: none"> • If your share path is \server_hostname\foldername\path, then type //server_hostname/foldername/path. • Make sure that you use forward slashes when typing the share path. d. From the Authentication menu, select your authentication method. <p>If Authentication is set to “Use assigned username and password,” then in the User Name and Password fields, type your credentials.</p> e. Click Save. <p>Can you scan a document and save it to a network folder?</p>	<p>The problem is solved.</p>	<p>Go to step 5.</p>
<p>Step 5</p> <p>Make sure that the printer and the network folder are connected to the same network.</p>	<p>The problem is solved.</p>	<p>Refer to Contacting Customer Support.</p>

Troubleshoot a problem

Action	Yes	No
Can you scan a document and save it to a network folder?		

Partial copies of document or photo

Action	Yes	No
Step 1 a. Make sure that the document or photo is loaded facedown on the upper left corner of the scanner glass. b. Copy the document or photo. Is the document or photo copied correctly?	The problem is solved.	Go to step 2.
Step 2 a. Match the paper size setting and the paper loaded in the tray. b. Copy the document or photo. Is the document or photo copied correctly?	The problem is solved.	Refer to Contacting Customer Support .

Scan job was not successful

Action	Yes	No
<p>Step 1 Check the cable connections.</p> <ol style="list-style-type: none"> Make sure that the Ethernet or USB cable is securely connected to the computer and the printer. Resend the scan job. <p>Is the scan job successful?</p>	The problem is solved.	Go to step 2.
<p>Step 2 Check the file you want to scan.</p> <ol style="list-style-type: none"> Make sure that the file name is not already used in the destination folder. Make sure that the document or photo you want to scan is not open in another application. Resend the scan job. <p>Is the scan job successful?</p>	The problem is solved.	Go to step 3.
<p>Step 3</p> <ol style="list-style-type: none"> Make sure that the Append time stamp or the Overwrite existing file check box is selected in the destination configuration settings. Resend the scan job. <p>Is the scan job successful?</p>	The problem is solved.	Refer to Contacting Customer Support .

Poor copy quality

Action	Yes	No
<p>Step 1</p> <p>a. Clean the scanner glass and the ADF glass with a damp, soft, lint-free cloth. If your printer has a second ADF glass inside the ADF, then also clean that glass.</p> <p>For more information, see Cleaning the Scanner.</p> <p>b. Make sure that the document or photo is loaded facedown on the upper left corner of the scanner glass.</p> <p>c. Copy the document or photo.</p> <p>Is the copy quality satisfactory?</p>	<p>The problem is solved.</p>	<p>Go to step 2.</p>
<p>Step 2</p> <p>a. Check the quality of the original document or photo.</p> <p>b. Adjust the scan quality settings.</p> <p>c. Copy the document or photo.</p> <p>Is the copy quality satisfactory?</p>	<p>The problem is solved.</p>	<p>Refer to Contacting Customer Support.</p>

Vertical dark streaks on output when scanning from the ADF

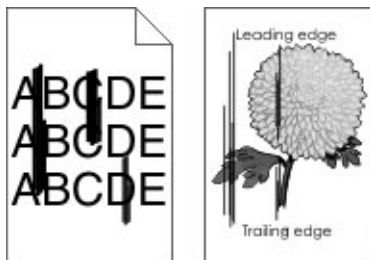

Action	Yes	No
<p>a. Open the scanner cover. b. Using a damp, soft, lint-free cloth, wipe the ADF glass and the ADF glass pad. c. Close the scanner cover. d. Scan the document.</p> <p>Do vertical streaks appear on scanned documents?</p>	<p>Refer to Contacting Customer Support.</p>	<p>The problem is solved.</p>

Scanner does not close

Action	Yes	No
<p>Remove obstructions that keep the scanner cover open.</p> <p>Did the scanner cover close correctly?</p>	<p>The problem is solved.</p>	<p>Refer to Contacting Customer Support.</p>

Scanning takes too long or freezes the computer

Action	Yes	No
<p>Close all applications that are interfering with the scan.</p> <p>Does scanning take too long or freeze the computer?</p>	<p>Refer to Contacting Customer Support.</p>	<p>The problem is solved.</p>

Scanner does not respond

Action	Yes	No
<p>Step 1</p> <p>a. Check if the power cord is connected properly to the printer and the electrical outlet.</p> <p>To avoid the risk of fire or electrical shock, connect the power cord to an appropriately rated and properly grounded electrical outlet that is near the product and easily accessible.</p> <p>b. Copy or scan the document.</p> <p>Is the scanner responding?</p>	The problem is solved.	Go to step 2.
<p>Step 2</p> <p>a. Check if the printer is turned on.</p> <p>b. Resolve any error messages that appear on the display.</p> <p>c. Copy or scan the document.</p> <p>Is the scanner responding?</p>	The problem is solved.	Go to step 3.
<p>Step 3</p> <p>a. Turn off the printer, wait for about 10 seconds, and then turn the printer on.</p> <p>b. Copy or scan the document.</p> <p>Is the scanner responding?</p>	The problem is solved.	Refer to Contacting Customer Support .

Adjusting scanner registration

1. From the control panel, navigate to **Settings > Device > Maintenance > Config Menu > Scanner Configuration > Scanner Manual Registration > Print Quick Test**.

For non-touch-screen printer models, press **OK** to navigate through the settings.

2. Place the Print Quick Test page on the scanner glass, and then select **Flatbed Registration**.
3. Select **Copy Quick Test**.
4. Compare the Copy Quick Test page with the original document.

 **Note:** If the margins of the test page are different from the original document, then adjust Left Margin and Top Margin.

5. Repeat [Step 3](#) and [Step 4](#) and until the margins of the Copy Quick Test page closely match the original document.

Adjusting ADF registration

1. From the control panel, navigate to **Settings > Device > Maintenance > Config Menu > Scanner Configuration > Scanner Manual Registration > Print Quick Test**.

For non-touch-screen printer models, press **OK** to navigate through the settings.

2. Place the Print Quick Test page on the ADF tray, and then select **Front ADF Registration**.

 **Note:** To align the front ADF registration, place the test page faceup, short edge first into the ADF.

3. Select **Copy Quick Test**.
4. Compare the Copy Quick Test page with the original document.

 **Note:** If the margins of the test page are different from the original document, then adjust Horizontal Adjust and Top Margin.

5. Repeat [Step 3](#) and [Step 4](#) and until the margins of the Copy Quick Test page closely match the original document.

Contacting Customer Support

Before contacting customer support, make sure to have the following information:

- Printer problem
- Error message
- Printer model type and serial number

To receive email, chat support, or to browse the supported documentation, drivers, and other downloads, go to www.xerox.com, click on the **Customer Support** link, and search for your product.

Technical support via telephone is also available. In the U.S. or Canada, go to www.xerox.com/supplies. For other countries or regions, go to or contact the place where you purchased the printer.

A

Regulatory Information

This appendix contains:

- [Basic Regulations](#) 282
- [Copy Regulations](#) 291
- [Material Safety Data Sheets](#) 294

Basic Regulations

Noise Emission Levels

The following measurements were made in accordance with ISO 7779 and reported in conformance with ISO 9296.

 **Note:** Some modes may not apply to your product.

1-meter Average Sound Pressure, dBA	
Printing	One-sided: 52 Two-sided: 50
Scanning	52
Copying	55
Ready	14

Static Sensitivity Notice



This symbol identifies static-sensitive parts. Do not touch the areas near these symbols without first touching a metal surface in an area away from the symbol.

To prevent damage from electrostatic discharge when performing maintenance tasks, such as clearing paper jams or replacing supplies, touch any exposed metal frame of the printer before accessing or touching interior areas of the printer, even if the symbol is not present.

ENERGY STAR



Any Xerox product bearing the ENERGY STAR emblem on the product or on a start-up screen is certified to comply with Environmental Protection Agency (EPA) ENERGY STAR requirements as of the date of manufacture.

Temperature Information

Ambient operating temperature	10 to 32.2°C (50 to 90°F)
Shipping temperature	-40 to 43.3°C (-40 to 110°F)
Storage temperature and relative humidity	-40 to 43.3°C (-40 to 110°F), 8 to 80% RH

Información de la energía de México

- Consumo de energía en operación: 550 Wh
- Consumo de energía en modo de espera: 0.1 Wh
- Cantidad de producto por unidad de energía consumida: 4.15 páginas/Wh

Laser Notice

The printer is certified in the U.S. to conform to the requirements of DHHS 21 CFR, Chapter I, Subchapter J for Class I (1) laser products, and elsewhere is certified as a Class I laser product conforming to the requirements of IEC 60825-1: 2014.

Class I laser products are not considered to be hazardous. The laser system and printer are designed so there is never any human access to laser radiation above a Class I level during normal operation, user maintenance, or prescribed service conditions. The printer has a non-serviceable printhead assembly that contains a laser with the following specifications:

- Class: IIIb (3b) AlGaAs
- Nominal output power (milliwatts): 15
- Wavelength (nanometers): 775–800

Power

Product Power Consumption

The following table documents the power consumption characteristics of the product.

 **Note:** Some modes may not apply to your product.

Mode	Description	Power consumption (Watts)
Printing	The product is generating hard-copy output from electronic inputs.	One-sided: 460 Two-sided: 325
Copy	The product is generating hard-copy output from hard-copy original documents.	460
Scan	The product is scanning hard-copy documents.	N/A (B225); 9.5 (B235, flash drive)
Ready	The product is waiting for a print job.	5.5 (B225); 6.0 (B235)
Sleep Mode	The product is in a high-level energy-saving mode.	1.2 (B225) or 1.1 (B235)
Hibernate	The product is in a low-level energy-saving mode.	N/A
Off	The product is plugged into an electrical outlet, but the power switch is turned off.	0.1 (B225); 0.2 (B235)

The power consumption levels listed in the previous table represent time-averaged measurements. Instantaneous power draws may be substantially higher than the average.

Sleep Mode

This product is designed with an energy-saving mode called Sleep Mode. The Sleep Mode saves energy by lowering power consumption during extended periods of inactivity. The Sleep Mode is automatically engaged after this product is not used for a specified period of time, called the Sleep Mode Timeout.

 **Note:** Factory default Sleep Mode Timeout for this product is 15 minutes.

By using the configuration menus, the Sleep Mode Timeout can be modified between 1 minute and 120 minutes. If the print speed is less than or equal to 30 pages per minute, then you can set the timeout only up to 60 minutes. Setting the Sleep Mode Timeout to a low value reduces energy consumption, but may increase the response time of the product. Setting the Sleep Mode Timeout to a high value maintains a fast response, but uses more energy.

Hibernate Mode

This product is designed with an ultra-low power operating mode called Hibernate mode. When operating in Hibernate Mode, all other systems and devices are powered down safely.

The Hibernate mode can be entered in any of the following methods:

- Using the Hibernate Timeout
- Using the Schedule Power modes

 **Note:** Factory default Hibernate Timeout for this product in all countries or regions is 3 days.

The amount of time the printer waits after a job is printed before it enters Hibernate mode can be modified between one hour and one month.

Off Mode

If this product has an off mode which still consumes a small amount of power, then to completely stop product power consumption, disconnect the power supply cord from the electrical outlet.

Total Energy Usage

It is sometimes helpful to estimate the total product energy usage. Since power consumption claims are provided in power units of Watts, the power consumption should be multiplied by the time the product spends in each mode in order to calculate energy usage. The total product energy usage is the sum of each mode's energy usage.

Telecommunication Regulatory Notices

Regulatory Notices for Telecommunication Terminal Equipment

This section contains regulatory information pertaining to products that contain the analog facsimile card.

FCC Requirements Notice to Users of the US Telephone Network

This equipment complies with Part 68 of the FCC rules and the requirements adopted by the Administrative Council for Terminal Attachments (ACTA). On the back of this equipment is a label that contains, among other information, a product identifier in the format US:AAAEQ##TXXXX. If requested, this number must be provided to your telephone company.

This equipment uses the RJ-11C Universal Service Order Code (USOC) jack.

A plug and jack used to connect this equipment to the premises' wiring and telephone network must comply with the applicable FCC Part 68 rules and requirements adopted by the ACTA. Use a compliant telephone cord (RJ-11) that is 26 AWG or larger when connecting this product to the public switched telephone network. See your setup documentation for more information.

The Ringer Equivalence Number (REN) is used to determine the number of devices that may be connected to a telephone line. Excessive RENs on a telephone line may result in the devices not ringing in response to an incoming call. In most but not all areas, the sum of RENs should not exceed five (5.0). To be certain of the number of devices that may be connected to a line, as determined by the total RENs, contact your local telephone company. For products approved after July 23, 2001, the REN for this product is part of the product identifier that has the format US:AAAEQ##TXXXX. The digits represented by ## are the REN without a decimal point (for example, 03 is a REN of 0.3). For earlier products, the REN is shown separately on the label.

If this equipment causes harm to the telephone network, the telephone company will notify you in advance that temporary discontinuance of service may be required. If advance notice is not practical, the telephone company will notify the customer as soon as possible. You will also be advised of your right to file a complaint with the FCC.

The telephone company may make changes in its facilities, equipment, operations or procedures that could affect the operation of this equipment. If this happens, the telephone company will provide advance notice in order for you to make necessary modifications to maintain uninterrupted service.

If you experience trouble with this equipment, for repair or warranty information, contact your point of purchase. If the equipment is causing harm to the telephone network, the telephone company may request that you disconnect the equipment until the problem is resolved.

This equipment contains no user serviceable parts. For repair and warranty information, contact your point of purchase.

Connection to party line service is subject to state tariffs. Contact the state public utility commission, public service commission, or corporation commission for information.

If your home has specially wired alarm equipment connected to the telephone line, ensure the installation of this equipment does not disable your alarm equipment. If you have questions about what will disable alarm equipment, consult your telephone company or a qualified installer.

The Telephone Consumer Protection Act of 1991 makes it unlawful for any person to use a computer or other electronic device, including fax machines, to send any message unless said message clearly contains in a margin at the top or bottom of each transmitted page or on the first page of the transmission, the date and time it is sent and an identification of the business or other entity, or other individual sending the message, and the telephone number of the sending machine or such business, other entity, or individual. (The telephone number provided may not be a 900 number or any other number for which charges exceed local or long-distance transmission charges.)

Refer to your user documentation in order to program this information into your fax machine.

Notice to Users of the Canadian Telephone Network

This product meets the applicable Innovation, Science and Economic Development Canada technical specifications.

The Ringer Equivalence Number (REN) indicates the maximum number of devices allowed to be connected to a telephone interface. The termination of an interface may consist of any combination of devices subject only to the requirement that the sum of the RENs of all the devices not exceed five. The REN is located on the product label.

This equipment uses CA11A telephone jacks.

Avis Réservé aux Utilisateurs du Réseau Téléphonique du Canada

Ce produit est conforme aux spécifications techniques d'Innovation, Sciences et Développement économique Canada.

Le numéro REN (ringer equivalence number: numéro d'équivalence de sonnerie) indique le nombre maximum d'appareils pouvant être connectés à l'interface téléphonique. En bout de ligne, le nombre d'appareils qui peuvent être connectés n'est pas directement limité, mais la somme des REN de ces appareils ne doit pas dépasser cinq. Le numéro REN est indiqué sur l'étiquette produit.

Cet équipement utilise des prises de téléphone CA11A.

Notice to Users of the New Zealand Telephone Network

The following are special conditions for the Facsimile User Instructions. The grant of a telepermit for any item of terminal equipment indicates only that Telecom has accepted that the item complies with minimum conditions for connection to its network. It indicates no endorsement of the product by Telecom, nor does it provide any sort of warranty. Above all, it provides no assurance that any item will work correctly in all respects with another item of telepermitted equipment of a different make or model, nor does it imply that any product is compatible with all of Telecom's network services.

This equipment shall not be set up to make automatic calls to the Telecom "111" Emergency Service.

This equipment may not provide for the effective hand-over of a call to another device connected to the same line.

This equipment should not be used under any circumstances that may constitute a nuisance to other Telecom customers.

This equipment is not capable, under all operating conditions, of correct operation at the higher speeds for which it is designed. Telecom will accept no responsibility should difficulties arise in such circumstances.

The decadic (or pulse) dialing on this device is unsuitable for use on the Telecom network in New Zealand.

For correct operation, the total of all the Ringer Equivalence Numbers (RENs) of all parallel devices connected to the same telephone line may not exceed 5. The REN of this device is located on the label.

This device uses an RJ-11C modular connector. Contact your point of purchase if a BT adapter is required.

Some parameters required for compliance with Telecom's telepermit requirements are dependent on the equipment associated with this device. The associated equipment shall be set to operate within the following limits for compliance to Telecom's specifications:

- There shall be no more than 10 call attempts to the same number within any 30 minute period for any single manual call initiation, and
- The equipment shall go on-hook for a period of not less than 30 seconds between the end of one attempt and the beginning of the next call attempt.
- The equipment shall be set to ensure that automatic calls to different numbers are spaced such that there is not less than 5 seconds between the end of one call attempt and the beginning of another.

Verwendung dieses Produkts in Deutschland

Für dieses Produkt muss ein deutscher Billing Tone Filter zur Zählzeichenübertragung für jede Leitung installiert werden, über die in Deutschland Zeitsteuertakte übertragen werden. Zeitsteuertakte sind in analogen Leitungen in Deutschland möglicherweise nicht vorhanden. Der Teilnehmer kann die Bereitstellung von Zeitsteuertakten veranlassen oder beim deutschen Netzanbieter telefonisch deren Deaktivierung beantragen. Im Regelfall werden Zeitsteuertakte nur dann bereitgestellt, wenn dies vom Teilnehmer bei der Installation ausdrücklich erwünscht wird.

Using this Product in Switzerland

This product requires a Swiss billing tone filter to be installed on any line which receives metering pulses in Switzerland.

Utilisation de ce produit en Suisse

Cet appareil nécessite l'utilisation d'un filtre de tonalité de facturation suisse devant être installé sur toute ligne recevant des impulsions de comptage en Suisse.

Verwendung dieses Produkts in der Schweiz

Für dieses Produkt muss ein schweizerischer Billing Tone Filter zur Zählzeichenübertragung für jede Leitung installiert werden, über die in der Schweiz Zeitsteuertakte übertragen werden.

Uso del prodotto in Svizzera

Questo prodotto richiede un filtro toni Billing svizzero, da installare su tutte le linee che ricevono impulsi remoti in Svizzera.

Regulatory Notices for Wireless Products

This section contains regulatory information that applies only to wireless models.

If in doubt as to whether your model is a wireless model, go to <http://support.xerox.com>.

Modular Component Notice

Wireless models contain modular components. To determine which modular components are installed in your particular product, refer to the labeling on your actual product.

Exposure to Radio Frequency Radiation

The radiated output power of this device is far below the radio frequency exposure limits of the FCC and other regulatory agencies. A minimum separation of 20 cm (8 inches) must be maintained between the antenna and any persons for this device to satisfy the RF exposure requirements of the FCC and other regulatory agencies.

Innovation, Science and Economic Development Canada

This device complies with Innovation, Science and Economic Development Canada license-exempt RSS standards. Operation is subject to the following two conditions:

1. This device may not cause interference, and
2. This device must accept any interference, including interference that may cause undesired operation of the device.

Innovation, Sciences et Développement économique Canada

Cet appareil est conforme aux normes RSS exemptes de licence d'Innovation, Sciences et Développement économique Canada. Son fonctionnement est soumis aux deux conditions suivantes:

1. Cet appareil ne doit pas causer d'interférences et
2. Il doit accepter toutes les interférences, y compris les celles qui peuvent entraîner un fonctionnement indésirable.

European Union and European Economic Area Compliance



The CE mark applied to this product indicates compliance to applicable EU Directives. The full text of the EU Declaration of Conformity is located at <https://www.xerox.com/en-us/about/ehs>.

Restrictions

This radio equipment is restricted to indoor use only. Outdoor use is prohibited. This restriction applies to all the countries listed in the table below:

					
AT	BE	BG	CH	CY	CZ
DE	DK	EE	EL	ES	FI
FR	HR	HU	IE	IS	IT
LI	LT	LU	LV	MT	
NL	NO	PL	PT	RO	
SE	SI	SK	TR	UK	

EU and Other Countries Statement of Radio Transmitter Operational Frequency Bands and Maximum RF Power

This radio product transmits in either the 2.4GHz (2.412–2.472 GHz in the EU) or 5GHz (5.15–5.35, 5.47–5.725 in the EU) bands. The maximum transmitter EIRP power output, including antenna gain, is $\leq 20\text{dBm}$ for both bands.

Federal Communications Commission (FCC) Compliance Information Statement

This product has been tested and found to comply with the limits for a Class B digital device, pursuant to Part 15 of the FCC Rules. Operation is subject to the following two conditions:

1. This device may not cause harmful interference, and
2. This device must accept any interference received, including interference that may cause undesired operation.

The FCC Class B limits are designed to provide reasonable protection against harmful interference when the equipment is operated in a residential installation. This equipment generates, uses, and can radiate radio frequency energy and, if not installed and used in accordance with the instructions, may cause harmful interference to radio communications. However, there is no guarantee that interference will not occur in a particular installation. If this equipment does cause harmful interference to radio or television reception, which can be determined by turning the equipment off and on, the user is encouraged to try to correct the interference by one or more of the following measures:

- Reorient or relocate the receiving antenna.
- Increase the separation between the equipment and receiver.
- Connect the equipment into an outlet on a circuit different from that to which the receiver is connected.
- Consult your point of purchase or service representative for additional suggestions.

The manufacturer is not responsible for radio or television interference caused by using other than recommended cables or by unauthorized changes or modifications to this equipment. Unauthorized changes or modifications could void the user's authority to operate this equipment.



Note: To assure compliance with FCC regulations on electromagnetic interference for a Class B computing device, use a properly shielded and grounded cable. Use of a substitute cable not properly shielded and grounded may result in a violation of FCC regulations.

For more information on Environment, Health, and Safety in relation to this Xerox product and supplies, contact the following:

Web address: <https://www.xerox.com/en-us/about/ehs>

Call (US and Canada only): 1–800–ASK-XEROX (1–800–275–9376)

Email: EHS-Europe@xerox.com

Innovation, Science and Economic Development Canada Compliance Statement

This Class B digital apparatus meets all requirements of the Canadian Interference-Causing Equipment Standard ICES-003.

Avis de conformité aux normes de l’Innovation, Sciences et Développement économique Canada

Cet appareil numérique de classe B est conforme aux exigences de la norme canadienne relative aux équipements pouvant causer des interférences NMB-003.

Germany

Blendschutz

Das Gerät ist nicht für die Benutzung im unmittelbaren Gesichtsfeld am Bildschirmarbeitsplatz vorgesehen. Um störende Reflexionen am Bildschirmarbeitsplatz zu vermeiden, darf dieses Produkt nicht im unmittelbaren Gesichtsfeld platziert werden.

Importeur

Xerox GmbH

Hellersbergstraße 2-4

41460 Neuss

Deutschland

Turkey RoHS Regulation

In compliance with Article 7 (d), we hereby certify “it is in compliance with the EEE regulation.”

“EEE yönetmeliğine uygundur.”

Ukraine RoHS Compliance

Обладнання відповідає вимогам Технічного регламенту щодо обмеження використання деяких небезпечних речовин в електричному та електронному обладнанні, затвердженого постановою Кабінету Міністрів України від 3 грудня 2008 № 1057.

(The equipment complies with requirements of the Technical Regulation, approved by the Resolution of Cabinet of Ministry of Ukraine as of December 3, 2008, in terms of restrictions for the use of certain dangerous substances in electrical and electronic equipment.)

Copy Regulations

United States

Congress, by statute, has forbidden the reproduction of the following subjects under certain circumstances. Penalties of fine or imprisonment may be imposed on those guilty of making such reproductions.

1. Obligations or Securities of the United States Government, such as:
 - Certificates of Indebtedness.
 - National Bank Currency.
 - Coupons from Bonds.
 - Federal Reserve Bank Notes.
 - Silver Certificates.
 - Gold Certificates.
 - United States Bonds.
 - Treasury Notes.
 - Federal Reserve Notes.
 - Fractional Notes.
 - Certificates of Deposit.
 - Paper Money.
 - Bonds and Obligations of certain agencies of the government, such as FHA and so on.
 - Bonds. United States Savings Bonds may be photographed only for publicity purposes in connection with the campaign for the sale of such bonds.
 - Internal Revenue Stamps. If it is necessary to reproduce a legal document on which there is a canceled revenue stamp, this may be done provided the reproduction of the document is performed for lawful purposes.
 - Postage Stamps, canceled or uncanceled. For philatelic purposes, Postage Stamps may be photographed, provided the reproduction is in black and white and is less than 75% or more than 150% of the linear dimensions of the original.
 - Postal Money Orders.
 - Bills, Checks, or Drafts of money drawn by or upon authorized officers of the United States.
 - Stamps and other representatives of value, of whatever denomination, which have been or may be issued under any Act of Congress.
 - Adjusted Compensation Certificates for Veterans of the World Wars.
2. Obligations or Securities of any Foreign Government, Bank, or Corporation.
3. Copyrighted materials, unless permission of the copyright owner has been obtained or the reproduction falls within the "fair use" or library reproduction rights provisions of the copyright law. Further information of these provisions may be obtained from the Copyright Office, Library of Congress, Washington, D.C. 20559. Ask for Circular R21.

Regulatory Information

4. Certificate of Citizenship or Naturalization. Foreign Naturalization Certificates may be photographed.
5. Passports. Foreign Passports may be photographed.
6. Immigration papers.
7. Draft Registration Cards.
8. Selective Service Induction papers that bear any of the following Registrant's information:
 - Earnings or Income.
 - Court Record.
 - Physical or mental condition.
 - Dependency Status.
 - Previous military service.
 - Exception: United States military discharge certificates may be photographed.
9. Badges, Identification Cards, Passes, or Insignia carried by military personnel, or by members of the various Federal Departments, such as FBI, Treasure, and so on (unless photograph is ordered by the head of such department or bureau).

Reproducing the following is also prohibited in certain states:

- Automobile Licenses.
- Drivers' Licenses.
- Automobile Certificates of Title.

The preceding list is not all inclusive, and no liability is assumed for its completeness or accuracy. In case of doubt, consult your attorney.

For more information about these provisions contact the Copyright Office, Library of Congress, Washington, D.C. 20559. Ask for Circular R21.

Canada

Parliament, by stature, has forbidden the reproduction of the following subjects under certain circumstances. Penalties of fine or imprisonment may be imposed on those guilty of making such reproductions.

- Current bank notes or current paper money
- Obligations or securities of a government or bank
- Exchequer bill paper or revenue paper
- The public seal of Canada or of a province, or the seal of a public body or authority in Canada, or of a court of law
- Proclamations, orders, regulations, or appointments, or notices thereof (with intent to falsely cause same to purport to have been printed by the Queens Printer for Canada, or the equivalent printer for a province)
- Marks, brands, seals, wrappers, or designs used by or on behalf of the Government of Canada or of a province, the government of a state other than Canada or a department, board, Commission, or

agency established by the Government of Canada or of a province or of a government of a state other than Canada

- Impressed or adhesive stamps used for the purpose of revenue by the Government of Canada or of a province or by the government of a state other than Canada
- Documents, registers, or records kept by public officials charged with the duty of making or issuing certified copies thereof, where the copy falsely purports to be a certified copy thereof
- Copyrighted material or trademarks of any manner or kind without the consent of the copyright or trademark owner

This list is provided for your convenience and assistance, but it is not all-inclusive, and no liability is assumed for its completeness or accuracy. In case of doubt, consult your solicitor.

Other Countries

Copying certain documents may be illegal in your country. Penalties of fine or imprisonment may be imposed on those found guilty of making such reproductions.

- Currency notes
- Bank notes and checks
- Bank and government bonds and securities
- Passports and identification cards
- Copyright material or trademarks without the consent of the owner
- Postage stamps and other negotiable instruments

This list is not inclusive and no liability is assumed for either its completeness or accuracy. In case of doubt, contact your legal counsel.

Material Safety Data Sheets

For Material Safety Data information regarding your printer, go to:

- Web Address: <https://safety sheets.business.xerox.com/en-us/>
- United States and Canada: 1-800-ASK-XEROX (1-800-275-9376)
- Other markets, send an email request to EHS-Europe@xerox.com

B

Recycling and Disposal

This appendix contains:

- [Product Disposal and Recycling](#) 296
- [North America](#) 297
- [Xerox Green World Alliance](#) 298
- [Waste from Electrical and Electronic Equipment \(WEEE\) Directive](#) 299

Product Disposal and Recycling

Do not dispose of the printer or supplies in the same manner as normal household waste. Consult your local authorities for disposal and recycling options.

North America

Xerox operates an equipment take-back and reuse and recycle program. Contact your Xerox representative (1-800-ASK-XEROX) to determine if this Xerox product is part of the program. For more information about Xerox environmental programs, go to <https://www.xerox.com/en-us/about/ehs>.

Xerox Green World Alliance

The Xerox Green World Alliance Program allows you to return qualified supplies to Xerox for reuse or recycling. One hundred percent of the empty cartridges returned to Xerox are either reused or de-manufactured for recycling. The boxes used to return the cartridges are also recycled.

To return Xerox cartridges for reuse or recycling, do the following:

1. Go to <https://www.xerox.com/office/recycle>.
2. Click **Recycling**.
3. Select an option for return.

Waste from Electrical and Electronic Equipment (WEEE) Directive



The WEEE logo signifies specific recycling programs and procedures for electronic products in countries of the European Union. We encourage the recycling of our products.

If you have further questions about recycling options, contact your local sales office.

India E-Waste notice



This product including components, consumables, parts and spares complies with the “India E-Waste Rules” and prohibits use of lead, mercury, hexavalent chromium, polybrominated biphenyls or polybrominated diphenyl ethers in concentrations exceeding 0.1 % by weight and 0.01 % by weight for cadmium, except for the exemption set in the Rule.

